

Operator's Manual

LeCroy

LC Series Color

Digital Oscilloscopes

Revision K — December 1999





LeCroy

LeCroy Corporation

700 Chestnut Ridge Road
Chestnut Ridge, NY 10977-6499
Tel: (914) 578 6020, Fax: (914) 578 5985

LeCroy SA

2, rue du Pré-de-la-Fontaine
1217 Meyrin 1/Geneva, Switzerland
Tel: (41) 22 719 21 11, Fax: (41) 22 782 39 15

Internet: www.lecroy.com

Copyright © January 1999, LeCroy. All rights reserved. Information in this publication supersedes all earlier versions. Specifications subject to change.

LeCroy, ProBus and SMART Trigger are registered trademarks of LeCroy Corporation. Centronics is a registered trademark of Data Computer Corp. Epson is a registered trademark of Epson America Inc. I²C is a trademark of Philips. MathCad is a registered trademark of MATHSOFT Inc. MATLAB is a registered trademark of The MathWorks, Inc. Microsoft, MS and Microsoft Access are registered trademarks, and Windows and NT trademarks, of Microsoft Corporation. PowerPC is a registered trademark of IBM Microelectronics. DeskJet, ThinkJet, QuietJet, LaserJet, PaintJet, HP 7470 and HP 7550 are registered trademarks of Hewlett-Packard Company.

Manufactured under
an ISO 9000
Registered
Quality Management
System
Visit www.lecroy.com
to view the certificate.



This electronic product is subject to disposal and recycling regulations that vary by country and region. Many countries prohibit the disposal of waste electronic equipment in standard waste receptacles. For more information about proper disposal and recycling of your LeCroy product, please visit www.lecroy.com/recycle.





Chapter 1 — Read This First!	
Warranty and Product Support	1-1
Chapter 2 — Instrument Architecture	
Overview	2-1
Block Diagrams	2-4
Chapter 3 — Installation and Safety	
	
Installation for Safe and Efficient Operation	3-1
Chapter 4 — Introduction to the Controls	
The Front Panel	4-1
The Main Controls	4-2
Choosing and Navigating in Menus	4-3
System Setup and Menu Controls	4-5
Screen Topography	4-8
Chapter 5 — CHANNELS, Coupling, and Probes	
Channel Controls	5-1
Coupling	5-3
Probes and Probe Calibration	5-5
Chapter 6 — TIMEBASE + TRIGGER	
TIMEBASE + TRIGGER Controls	6-1
Chapter 7 — Timebase Modes and Setup	
Timebase Sampling Modes	7-1
Combining Channels	7-5
Timebase Setup	7-6



Chapter 8 — Triggers and When to Use Them

Choosing the Right Trigger	8-1
Edge or SMART?	8-2
Edge Trigger	8-3
SMART Trigger®	8-9
TRIGGER SETUP: Edge	8-34
TRIGGER SETUP: SMART	8-35

Chapter 9 — ZOOM + MATH

Zoom and Math Controls	9-1
-------------------------------------	-----

Chapter 10 — Zoom, Mathematics, and Math Setup

Zooming for Precise Waveform Measurements	10-1
Math Functions and Options	10-2
Using Waveform Mathematics	10-5
Configuring for Zoom and Math	10-6
Setting Up FFT Span and Resolution	10-18

Chapter 11 — Display

Revealing the Complete Picture	11-1
How On-Screen Objects are Displayed	11-2
Analog Persistence	11-5
Setting Up the Display	11-7
Controlling Color	11-20

Chapter 12 — UTILITIES

Printing, Mass Storage, and Other Utilities	12-1
Hardcopy Setup	12-2
Time/Date Setup	12-4
GPIB/RS232 Setup	12-5
Mass Storage Utilities	12-7
Special Modes	12-19
CAL BNC Setup	12-23

Chapter 13 — WAVEFORM STORE & RECALL

Waveform Store.....	13-1
Waveform Recall.....	13-4

Chapter 14 — CURSORS/MEASURE & Parameters

Cursors: Tools for Measuring Signal Values	14-1
Parameters: Automatic Measurements.....	14-6
Pass/Fail Testing	14-15

Chapter 15 — PANEL SETUPS

Saving and Recalling Panel Setups	15-1
---	------

Chapter 16 — SHOW STATUS

The Complete Picture — Summarized	16-1
---	------

Appendix A — Specifications



Appendix B — Enhanced Resolution

Appendix C — Fast Fourier Transform (FFT)

Appendix D — Parameter Measurement

Appendix E — ASCII Waveform Export

Index

LeCroy National Contacts



BLANK PAGE

Warranty and Product Support

LeCroy recommends that you thoroughly inspect the contents of the oscilloscope packaging immediately upon receipt. Compare the contents to the packing list/invoice shipped with the instrument (and the list on page 1–3). Unless LeCroy is promptly notified of any missing or damaged item, we cannot accept responsibility for its replacement. Contact your nearest LeCroy Customer Service Center or national distributor immediately (telephone numbers are given in the back of this manual).

Warranty

LeCroy warrants its oscilloscope products for normal use and operation within specifications for a period of three years from the date of shipment. Calibration each year is recommended to ensure in-spec. performance. Spares, replacement parts and repairs are warranted for 90 days. The instrument's firmware has been thoroughly tested and is thought to be functional, but is supplied without warranty of any kind covering detailed performance. Products not made by LeCroy are covered solely by the warranty of the original equipment manufacturer.

Under the LeCroy warranty, LeCroy will repair or, at its option, replace any product returned within the warranty period to a LeCroy authorized service center. However, this will be done only if the product is determined after examination by LeCroy to be defective due to workmanship or materials, and not to have been caused by misuse, neglect or accident, or by abnormal conditions or operation.

Note: This warranty replaces all other warranties, expressed or implied, including but not limited to any implied warranty of merchantability, fitness, or adequacy for any particular purpose or use. LeCroy shall not be liable for any special, incidental, or consequential damages, whether in contract or otherwise. The client will be responsible for the transportation and insurance charges for the return of products to the service facility. LeCroy will return all products under warranty with transport prepaid.



Product Assistance

Help on installation, calibration, and the use of LeCroy equipment is available from the LeCroy Customer Service Center in your country (telephone numbers are given at the back of this manual).

Maintenance Agreements

LeCroy provides a variety of customer support services under Maintenance Agreements. Such agreements give extended warranty and allow clients to budget maintenance costs after the initial three-year warranty has expired. Other services such as installation, training, enhancements and on-site repairs are available through special supplemental support agreements.

Staying Up to Date

LeCroy is dedicated to offering state-of-the-art instruments by continually refining and improving the performance of LeCroy products. Because of the quick pace at which physical modifications may be implemented, this manual and related documentation may not agree in every detail with the products they describe. For example, there might be small discrepancies in the values of components that affect pulse shape, timing, or offset; and — infrequently — minor logic changes. Be assured, however, that the scope itself incorporates the most up-to-date circuitry.

LeCroy frequently updates firmware and software during servicing to improve scope performance, free of charge during warranty. You will be kept informed of such changes, through new or revised manuals and other publications.

Nevertheless, you should retain this original manual to refer to your scope's unchanged hardware specifications.

Service and Repair

Please return products that require maintenance to the Customer Service Department in your country, or to an authorized service facility. You are responsible for transportation charges to the factory, whereas all in-warranty products will be returned to you with transportation prepaid. Outside the warranty period, you will need to provide us with a purchase order number before we can repair your LeCroy product. You will be billed for parts and labor related to the repair work, and for shipping.

How to Return a Product Contact the nearest LeCroy Service Center or office to find out where to return the product. All returned products should be identified by model and serial number. You should describe the defect or failure, and provide your name and contact number. In the case of a product returned to the factory, a Return Authorization Number (RAN) should be used. The RAN can be obtained by contacting the Customer Service Department.

Return shipments should be prepaid. We cannot accept COD (Cash On Delivery) or Collect Return shipments. We recommend air freight.

It is important that the RAN be clearly shown on the outside of the shipping package for prompt forwarding to the appropriate LeCroy department.

What Comes with Your Scope The following items are shipped with the standard configuration of this oscilloscope:

- Front Scope Cover
- 10:1 10 MΩ PP005 Passive Probe — *one per channel*
- ProBus™ Single-Channel Adapter ***NOT APPLICABLE TO LC374, LC564 OR LC584 SERIES***
- Two 250-V Fuses
- AC Power Cord and Plug
- *Operator's Manual*
- *Remote Control Manual*
- *Hands-On Guide*
- Performance Certificate or Calibration Certificate
- Declaration of Conformity
- Warranty

Note: Wherever possible, please use the original shipping carton. If a substitute carton is used, it should be rigid and packed so that that the product is surrounded by a minimum of four inches (10 cm) of shock absorbent material.

#



Read This First!

BLANK PAGE

Overview of Instrument Architecture

Each of the four channels of a LeCroy LC Color Digital Storage Oscilloscope (DSO) has one or more 8-bit Analog-to-Digital Converters (ADCs). Combine channels by interleaving ADCs to substantially increase the instrument's acquisition memory and sampling rate.

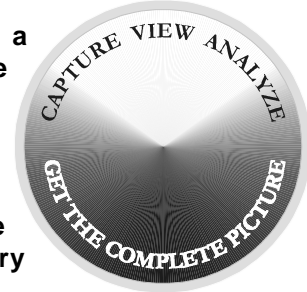

Processors

The central processing unit (CPU), a PowerPC® microprocessor, performs the oscilloscope's computations and controls its operation. A wide range of peripheral interfaces allow remote control, storage of waveforms and other data, and printing. A support processor constantly monitors the front-panel controls. Data processing is fast, with data either transferred to display memory for direct waveform display or stored in reference memories (see "Memories" below).

Note: Wherever a feature is specific or not applicable to a particular model or series of models, the applicability is indicated as, for example: **LC564 AND LC584 SERIES ONLY.**

See Appendix A for each model's complete specifications.

ADCs

The instrument's ADC architecture is designed to give excellent amplitude and phase correlation, maximum analog-to-digital conversion performance, large record lengths and superior time resolution.

Memories

The long acquisition memories simplify signal acquisition by producing waveform records that allow detailed analysis over large time intervals. Combining two or four channels (**FOUR-CHANNEL COMBINING NOT AVAILABLE ON LC564 SERIES**) increases acquisition memory length. There are four memories for temporary storage, and four more for waveform zooming and processing.

RIS

Repetitive signals can be acquired and stored at a Random Interleaved Sampling (RIS) rate of 10 GS/s for all models except **LC564, LC584, AND LC684 SERIES**, whose RIS rate is 25 GS/s. Moreover, this advanced digitizing technique enables measurement of repetitive signals with an effective sampling interval of 100 ps, or 40 ps for **LC564, LC584, AND LC684 SERIES**, and a measurement resolution of up to 10 ps (5 ps for **LC684 SERIES**). See Chapter 7.

Trigger System

Triggering can be controlled to a highly specialized degree in accordance with waveform characteristics and chosen trigger conditions. Menus and controls enable the selection and setting of parameters such as pre- and post-trigger recording, and of sequence and roll modes. The trigger source can be any of the input channels, line (synchronized to scope's main input supply) or external. The coupling is selected from AC, LF REJect, HF REJect, HF, and DC; the slope from positive and negative. The SMART Trigger® types offer a wide range of sophisticated trigger modes matched to special trigger conditions and sets of conditions. See Chapter 8.

Automatic Calibration

The oscilloscope's automatic calibration ensures an overall vertical accuracy of typically 1% of full scale. Vertical gain and offset calibration, and horizontal (time) resolution, take place each time the volts per division setting is modified. In addition, periodic and temperature-dependent autocalibration ensures long-term stability at the current setting.

Display System

The display's interactive, user-friendly interface is controlled by push-buttons and knobs to display as many as eight different waveforms at once. The parameters that control signal acquisition are reported simultaneously. The screen presents internal status and measurement results, as well as operational, measurement, and waveform-analysis menus. See Chapters 4 and 16.

The large display area presents waveforms and data using Advanced Color Management. Overlap-mixing and contrast-enhancement functions ensure that overlapping waveforms remain distinct at all times. Both pre-set and personal color schemes are available. See Chapter 11.

The Analog Persistence™ function offers display attributes of an analog instrument with all the advantages of digital technology. The Full Screen function expands waveform grids to fill the entire screen. See Chapter 11.

A hard copy of the screen can be easily produced at any time by pressing the front-panel screen-dump button (see Chapter 12).

Direct or...

This is a truly digital instrument. Nevertheless the front-panel layout and controls will be familiar to users of analog oscilloscopes (see Chapter 4). Rapid response and instant representation of waveforms on the high-resolution screen add to this impression.

Four front panel setups can be stored internally and recalled directly or by remote control, thus ensuring rapid front panel configuration. When power is switched off, the current front panel settings are automatically stored for use when the scope is turned on again. See Chapter 15.

...Remote Control

The oscilloscope has also been designed for remote control operation in automated testing and computer-aided measurement applications. The entire measurement process, including cursor and pulse-parameter settings, dynamic modification of front-panel settings, and display organization, is controlled through the rear-panel industry-standard GPIB (IEEE-488) and standard RS-232-C ports whose connection or serial port are present on most of today's personal computers. For further details, please consult your remote control manual. See *Remote Control Manual*.

Scope Explorer

Also via GPIB and RS-232-C, the *Scope Explorer* software integrates the oscilloscope with Windows 95 and Windows NT desktop. It offers user-friendly remote control of the oscilloscope, copy of the display into Windows, and the recording to and storage in the PC of front-panel setups, which can then be transferred back to the oscilloscope. See Chapter 12 and the *Hands-On Guide* for more on PC and other interfaces.



Block Diagrams

- **LC334 Series**
- **LC374 Series**
- **LC534 Series**
- **LC574 Series**

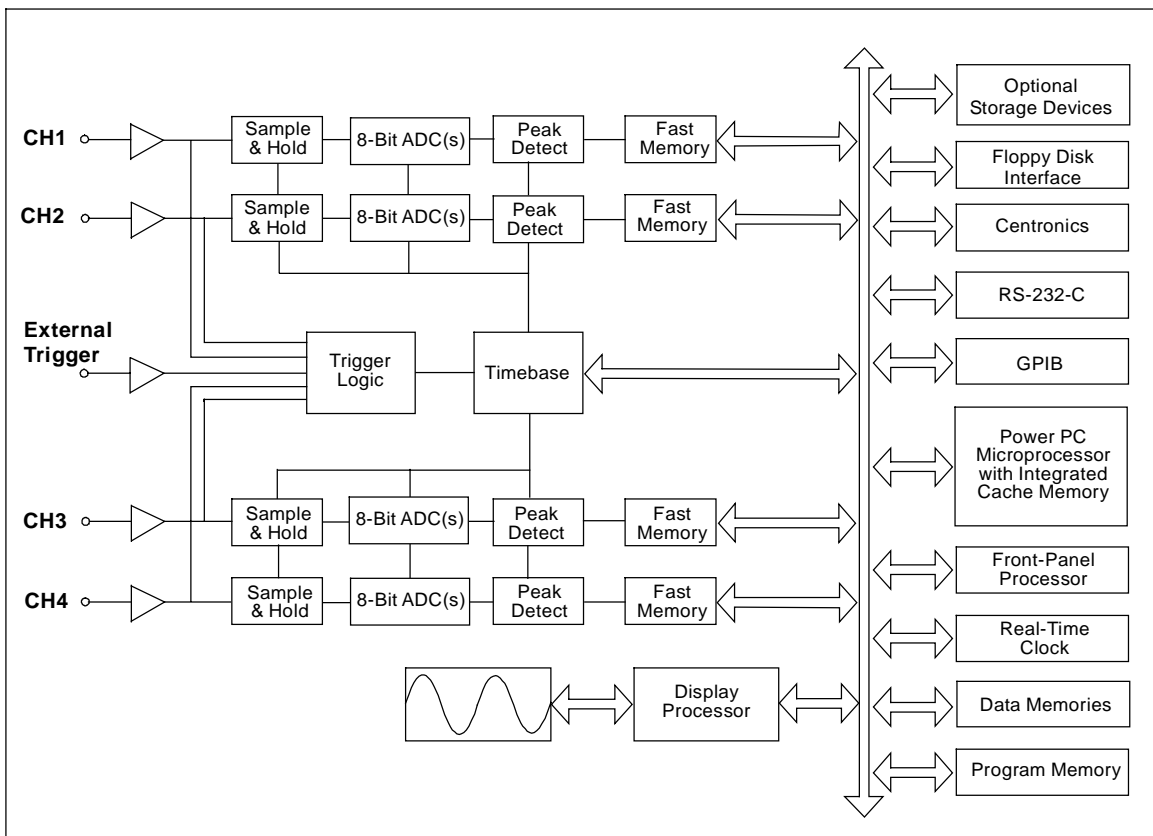

- **LC564 Series**
- **LC584 Series**
- **LC684 Series**

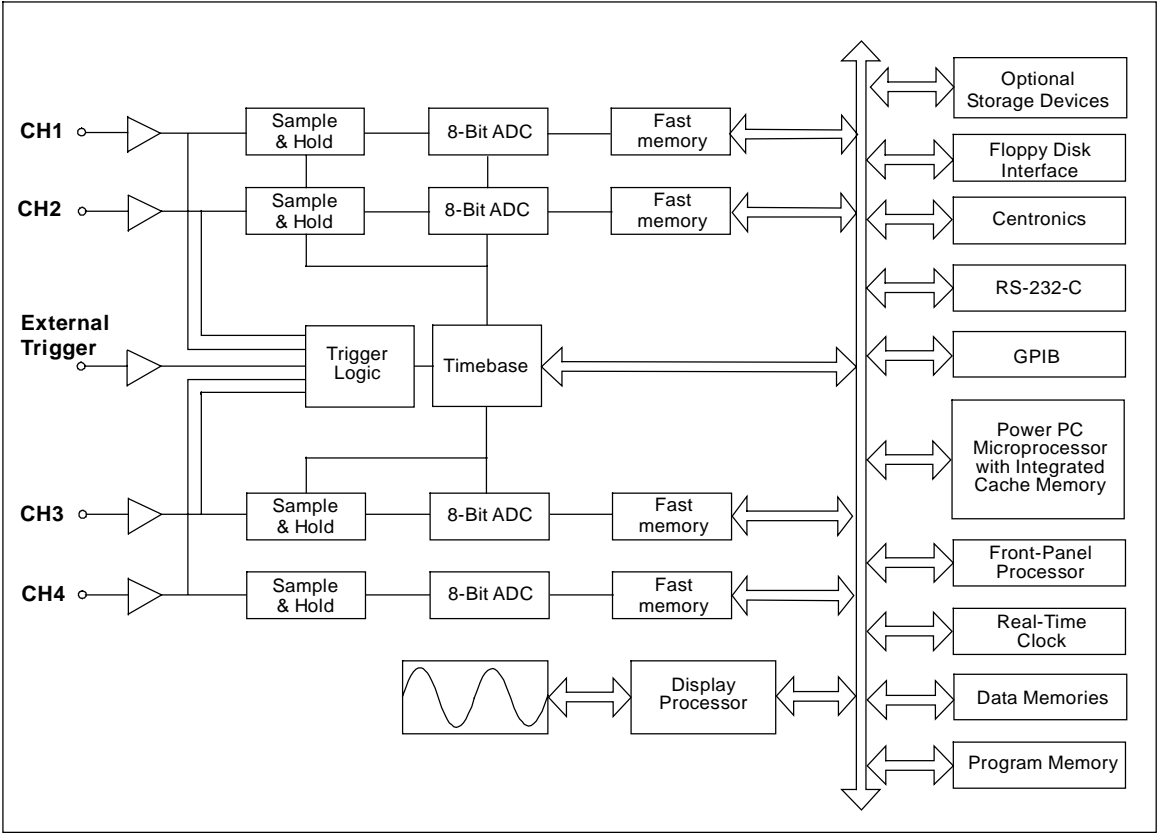

#



BLANK PAGE

Installation for Safe and Efficient Operation

Ensure that the operating environment is maintained within the following parameters for safe operation of the oscilloscope within specifications:

Operating Environment





- Temperature5 to 40 °C (41 to 104 °F)
- Humidity.....≤80% RH (non-condensing)
- Altitude.....≤2000 m (6560 ft)
- Operation.....indoor use only

The oscilloscope has been qualified to the following EN 61010-1 categories:

- Installation (Overvoltage) Category..... II
- Pollution Degree..... 2

Safety Symbols

Where the following symbols or indications appear on the instrument's front or rear panels, or elsewhere in this manual, they alert you to an aspect of safety.

Symbol	Meaning
	CAUTION: Refer to accompanying documents (for safety related information). <i>This symbol appears elsewhere in this manual, as indicated in the Table of Contents.</i>
	WARNING: Risk of electric shock.
	On (Supply)
	Off (Supply)



Installation and Safety

Symbol	Meaning
	Earth (Ground) Terminal
	Protective Conductor Terminal
	Alternating Current Only
	Chassis Terminal.
	Earth (Ground) Terminal on BNC Connectors.
WARNING	Denotes a hazard. If a WARNING is indicated on the instrument, do not proceed until its conditions are understood and met.



WARNING

Any use of this instrument in a manner not specified by the manufacturer may impair the instrument's safety protection. The oscilloscope has *not* been designed to make direct measurements on the human body. Users who connect a LeCroy oscilloscope directly to a person do so at their own risk.



Power Requirements

The oscilloscope operates from a 115 V (90 to 132 V) or 230 V (180 to 250 V) AC (~) power source at 45 to 66 Hz.

No voltage selection is required because the instrument automatically adapts to the line voltage that is present.

Fuses

The power supply of the oscilloscope is protected against short-circuit and overload by means of two fuses (T 6.3 A, 250 V) located above the mains plug.

Disconnect the power cord before inspecting or replacing a fuse. Open the fuse box by inserting a small screwdriver under the plastic cover and prying it open. For continued fire protection at all line voltages, replace only with fuses of the specified type and rating.

Ground

The oscilloscope has been designed to operate from a single-phase power source, with one of the current-carrying conductors (neutral conductor) at ground (earth) potential. Maintain the ground line to avoid electric shock.

None of the current-carrying conductors may exceed 250 V rms with respect to ground potential. The oscilloscope is provided with a three-wire electrical cord containing a three-terminal polarized plug for mains voltage and safety ground connection. The plug's ground terminal is connected directly to the frame of the unit. For adequate protection against electrical hazard, this plug must be inserted into a mating outlet containing a safety ground contact.

Cleaning and Maintenance

Maintenance and repairs should be carried out exclusively by a LeCroy technician (see Chapter 1). Cleaning should be limited to the exterior of the instrument only, using a damp, soft cloth. Do not use chemicals or abrasive elements. Under no circumstances should moisture be allowed to penetrate the oscilloscope. To avoid electric shock, unplug the instrument from the power outlet before cleaning.



Risk of electrical shock: No user-serviceable parts inside. Leave repair to qualified personnel.

Power On

Connect the oscilloscope to the power outlet and switch it on, using the power On/Off button located near the left-hand corner of the instrument below the screen. When the instrument is switched on, auto-calibration and a test of the oscilloscope's ADCs and memories are performed. The full testing procedure takes approximately 10 seconds, then a display will appear on the screen.

#



BLANK PAGE

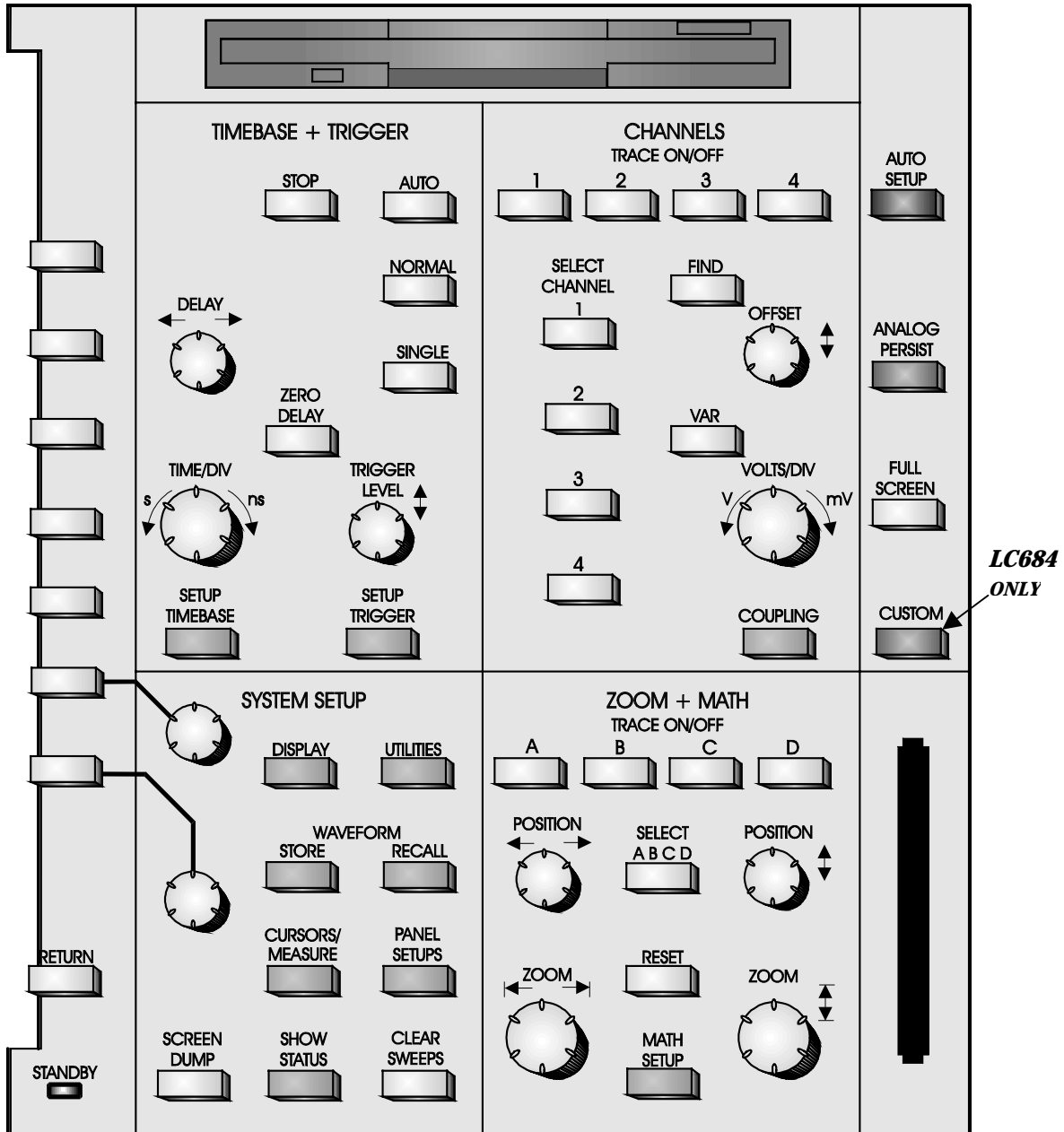



The Main Controls

The front-panel controls are divided into four main groups of buttons and knobs:

- **SYSTEM SETUP**
- **CHANNELS**
- **TIMEBASE + TRIGGER**
- **ZOOM + MATH**

Other buttons access special features.

SYSTEM SETUP

Dark gray menu entry buttons (also present in other groups of controls) provide access to the main on-screen menus and the instrument's acquisition, processing, and display modes. The SCREEN DUMP and CLEAR SWEEPS buttons copy or print the screen display, and restart operations that require several acquisitions. (See page 4–5.)

Menu Buttons & Knobs

The seven untitled buttons vertically aligned beside the screen, RETURN and the two linked rotary knobs enable on-screen menu selection. (See following pages.)

CHANNELS

This group of controls offers selection of displayed traces and adjustment of vertical sensitivity and offset. (See Chapter 5.)

TIMEBASE + TRIGGER

These controls allow direct adjustment of time/division, trigger level and delay, as well as access to the "TIMEBASE" and "TRIGGER" menu groups. (See Chapters 6, 7, and 8.)

ZOOM + MATH

This group controls trace selection, movement, definition, and expansion with Zoom and Math functions. (See Chapters 9 and 10.)

AUTO SETUP

This blue button automatically adjusts the scope to acquire and display signals on the active input channels. (See page 4–6.)

ANALOG PERSIST

This green button accesses the unique Analog Persistence™ feature. (See Chapter 11.)

FULL SCREEN

Redraws the grid to fill the entire screen. (See Chapter 11.)

See also:

Part 2, "Getting Started," in the Hands-On Guide for more information about the front panel, and a complete run-through of the controls.

Choosing and Navigating in Menus

On-screen menus — the panels along the right-hand side of the screen — are used to select specific scope actions and settings. All other on-screen text is for information only. The menus are broadly grouped according to function. The name of each menu group is shown at the top of the column of menus. Individual menus also have names at the top of their frames.

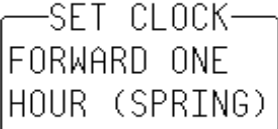

Each menu either contains a list of items or options — functions to be selected or variables modified — or performs a specific action when selected. Menus that perform actions are indicated by capitalized text, as in the example at left.

Displaying Menus and Selecting from them

When you press a menu entry button, the setup configuration for its particular group of functions is immediately displayed as a menu group. Once accessed, these menus are controlled by the menu buttons and the two menu knobs (illustrated at left).

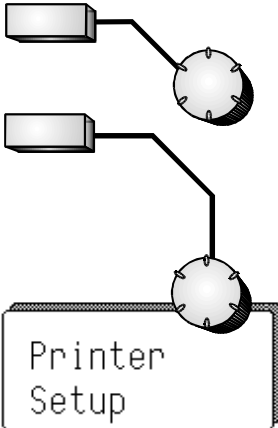

A menu button is active and can be pressed to make selections whenever a menu is visible beside it on-screen. The two menu knobs work with the two menu buttons to which they are joined by lines. Both control the menus currently shown beside them. Buttons and knobs are used either for selecting entire menus, particular items from menus, for moving up or down through menu lists, or for changing the values listed in menus.

Some menus have others behind them. Their presence is indicated by a heavy outline or shadow on the front menu, as illustrated at left. Pressing the corresponding menu button reveals the back menu. Pressing the RETURN button again displays the front menu.

A change of a menu value normally changes the screen because the new value is immediately used in acquisition settings, processing, or display.

Setting Menu Options

```
Math Type
Enh.Res
Extrema
FFT
FFTAVG
Functions
```

```
trigger on
Line Field
266 2
```

```
limit
+2.7 E+00
2 digits
```

The activated selection is highlighted in the menu. Press the corresponding menu button and the field will advance to highlight and select the next item on the menu. However, if there is only one item on a menu, pressing its button will have no effect.

Where a menu is associated with one of the two menu knobs, turning this knob in one direction or the other will cause the selector to move up or down the menu list.

Menus that span two menu buttons can be operated using both buttons. Pressing the lower of the two will move the selector down the menu list, while pressing the upper button will move the selector up the list.

An arrow on the side of a menu frame indicates that by pressing the button beside this arrow, the selector can be moved farther up or down the list. The arrow's direction shows whether the selector will move up or down. Arrows may also indicate that there are additional undiscovered items above or below the menu list. The respective arrow will disappear when the selector is at the very beginning or end of the list.

As in the examples at left, some menu button and knob combinations control the value of a continuously adjustable variable. The knob is then used to set its value, while the button either selects a value or makes a simple change in it.

Still other menu button and knob combinations control the value of several continuously adjustable variables, with the knob used to set the value and the button to highlight it.

Note: When the oscilloscope is placed in the remote state, the REMOTE ENABLE menu will be displayed. It will contain the command "GO TO LOCAL," which is activated by a menu button if the action is applicable. This is the only way to manually turn off the REMOTE ENABLE menu. The oscilloscope does not need to be in the remote state to accept remote commands.

SYSTEM SETUP and Menu Controls

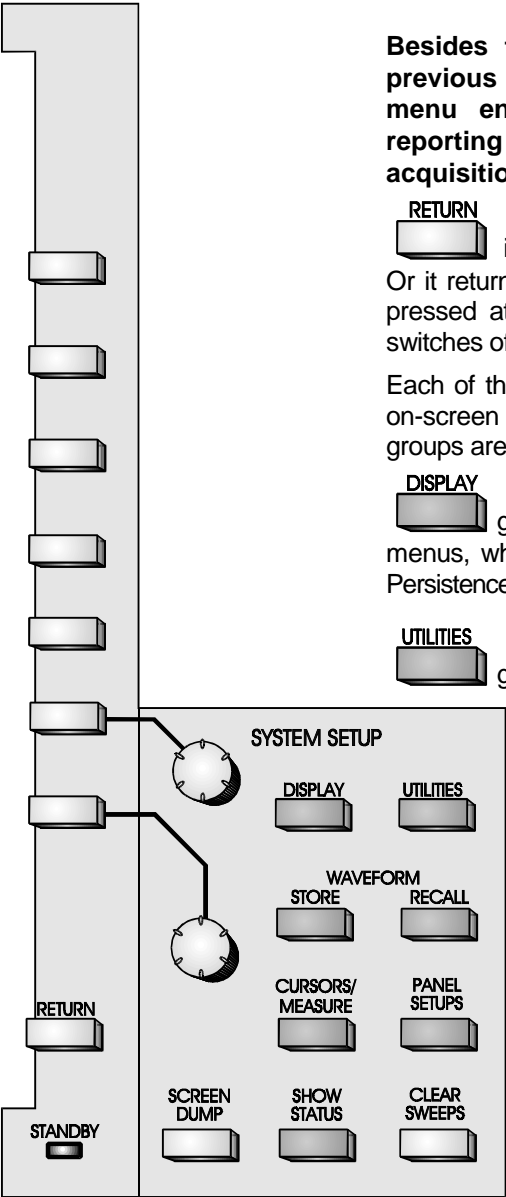

Besides the menu buttons and knobs described on the previous pages, the **SYSTEM SETUP** controls include the menu entry buttons and others for copying displays, reporting instrument status, and restarting multiple-acquisition operations.

RETURN is used to go back to the preceding displayed menu group. Or it returns the display to a higher-level, or primary menu. When pressed at the highest possible menu level, however, the button switches off that menu.

Each of the dark gray menu entry buttons activates a major set of on-screen menus. (Menu entry buttons that are part of other control groups are described in later chapters.)

DISPLAY gives you access to the "DISPLAY SETUP" group of menus, which control display mode, grids, intensities, Dot Join, and Persistence menus (Chapter 11).

UTILITIES gives you access to the "UTILITIES" menus, which control hardcopy setups, GPIB addresses and special modes of operation (Chapter 12).

WAVEFORM STORE gives you access to the "STORE W'FORM" menus that are used for storing waveforms in internal or external memory (Chapter 13).

WAVEFORM RECALL gives you access to the "RECALL W'FORM" menus that are used to retrieve waveforms stored in internal or external memory (Chapter 13).

CURSORS/ MEASURE

 gives you access to the “CURSORS” setup menus, which are used to make precise cursor measurements on traces, and the “MEASURE” menus, which are used for precise parameter measurements and pass/fail testing (Chapter 14).

PANEL SETUPS

 gives you access to the “PANEL SETUPS” menus, which are used for saving and recalling an instrument configuration (Chapter 13).

SHOW STATUS

 gives you access to the “STATUS” menu, which summarizes the instrument’s status for acquisition, system, and other functions (Chapter 16).

SCREEN DUMP

This button prints or plots the screen display to an on-line hardcopy device, via the GPIB, RS-232-C or Centronics interface ports, or directly to a built-in thermal graphics printer. You can also save screen displays as data files on floppy disk, memory card, or portable hard disk.

When SCREEN DUMP is pressed, *all* displayed information will be copied. However, it is possible to copy the waveforms without the grid by turning the grid intensity to zero, using the “Display Setup” menu.

While a screen dump is taking place — indicated by the on-screen “PRINTING” or “PLOTTING” message — you can cancel it by pressing SCREEN DUMP a second time. It takes a moment for the buffer to empty before copying stops (Chapter 12).

CLEAR SWEEPS

By resetting the sweep counter(s) to zero, this button restarts operations that require several acquisitions (sweeps) including averaging, extrema, persistence, parameter statistics, and pass/fail testing.



Press the blue AUTO SETUP button to automatically scale the timebase, trigger level, offset, and volts/div to provide a stable display of repetitive signals.

This button operates only on *active* channels. If no channels are switched on, and no signals are detected, AUTO SETUP will operate on *all* channels, switching all of them on. If signals are detected on several channels, the channel with the lowest number determines which timebase and trigger source are selected for setup.

Signals detected must have an amplitude from 5 mV to 40 V, a frequency greater than 50 Hz, and a duty cycle greater than 0.1%.

Resetting the Scope

To perform a general reset of the instrument, simultaneously press the AUTO SETUP, top menu, and RETURN buttons:



The oscilloscope will revert to its default power-up settings.



Screen Topography

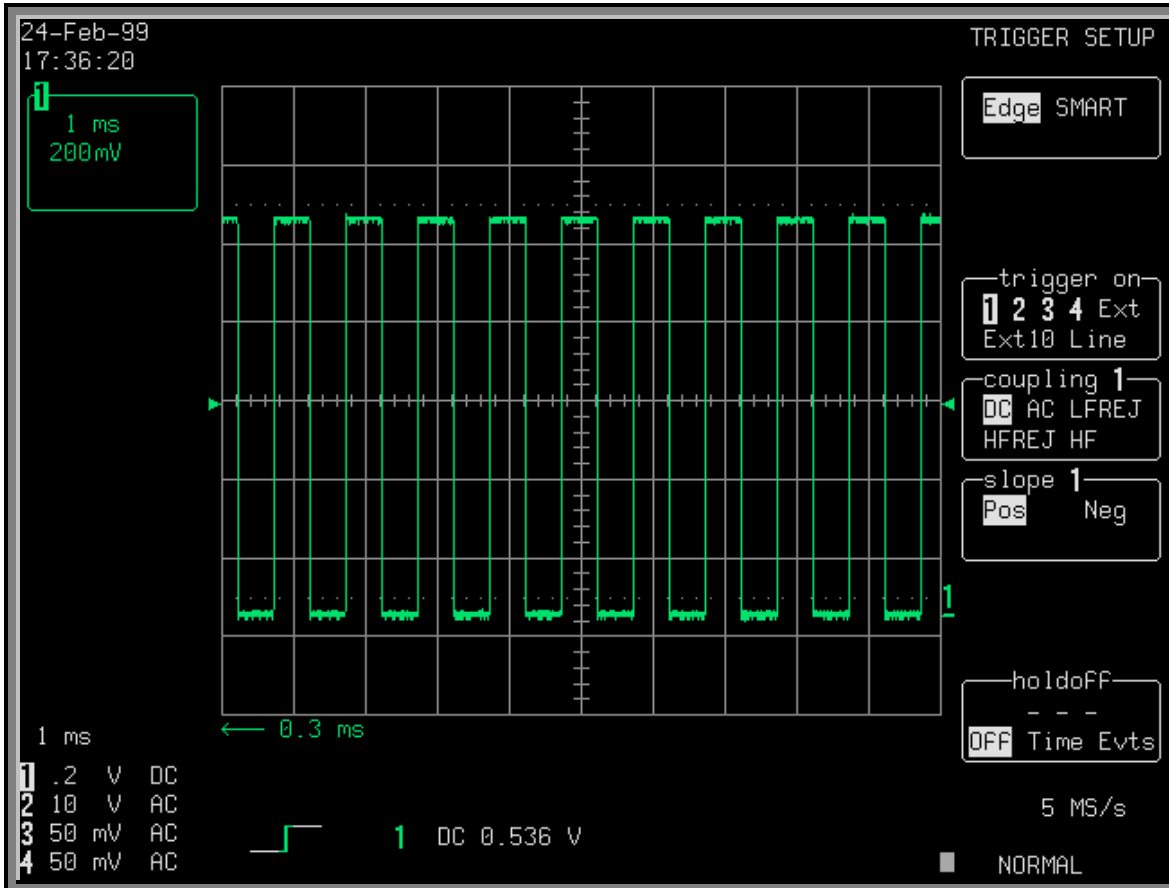

The grid area of the screen and the fields surrounding it provide a variety of useful information, and specific commands and functions.

24-Feb-99
15:37:42

1
1 ms
200 mV

1 ms
1 .2 V DC
2 10 V AC
3 50 mV AC
4 50 mV AC

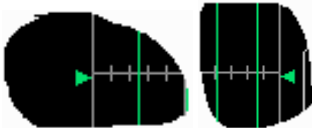

5 MS/s
NORMAL

1 DC 0.536 V

Real-Time Clock: Powered by a battery-backed real-time clock, this field displays the current date and time.

Displayed Trace Label: This field indicates each channel or channel displayed, the time/div and volts/div settings, and cursor readings where appropriate. It indicates the acquisition parameters set when the trace was captured or processed, whereas the Acquisition Summary field (see below) indicates the current setting.

Acquisition Summary: This field shows the timebase, volts/div, probe attenuation, and coupling for each channel, with the selected channel highlighted. It indicates the current setting, whereas the acquisition parameters that were set when the trace was captured or processed are indicated in the Displayed Trace label (above).

Trigger Level: The arrows on both sides of the grid mark the trigger voltage relative to ground potential.

Trigger Delay: Located below the grid, this field indicates the trigger time relative to the trace. The delay can be adjusted from zero to ten grid divisions (pre-trigger), or zero to -10 000 (post-trigger) off-screen. The pre-trigger delay appears as the upward-pointing arrow, whereas post-trigger is given as a delay in seconds.

Trigger Status: This field shows sample rate and trigger re-arming status (AUTO, NORMAL, SINGLE, STOPPED). The small rectangle flashes to indicate that an acquisition has been made.

Trigger Configuration: This field contains an icon indicating the type of trigger, and provides information on the trigger's source, slope, level and coupling, and other information when appropriate.



Other Screen Regions
(not shown)

Trace and Ground Level: This is the trace number and ground-level marker.

Time and Frequency: This area displays the time and frequency relative to cursors below the grid. For example, when the absolute time cursor (the cross-hair) is activated by selecting it from the “MEASURE” menu group, this field displays the time between the cursor and the trigger point.

Message: This area above the grid is used to display a variety of messages including warnings, system indications, and titles showing the instrument’s current status.

#

Channel Controls

These controls let you select displayed traces and adjust vertical sensitivity and offset.

TRACE ON/OFF

Press these buttons to display or switch off the corresponding channel trace. When a channel is switched on, OFFSET and VOLTS/DIV controls are assigned to this, the active channel.

SELECT CHANNEL

These buttons assign all vertical controls to one channel, regardless of the channel displayed. The selected channel number is highlighted in the Acquisition Summary field (see previous chapter).

FIND

This button automatically adjusts offset and volts/div to match the active channel's input signal.

OFFSET

This knob vertically positions the active channel.

VOLTS/DIV

This button selects the vertical sensitivity either in a 1–2–5 sequence or continuously (see VAR, below). From the "SPECIAL MODES" menu, you can select the effect of gain changes on the acquisition offset.

VAR

The variability knob allows you to determine whether the VOLTS/DIV knob will modify the vertical sensitivity in a continuous manner or in discrete 1–2–5 steps.

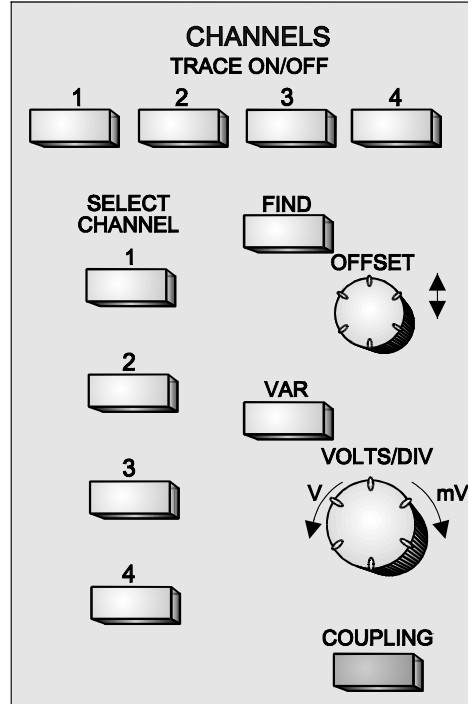



CHANNELS, Coupling, and Probes

The format of the vertical sensitivity in the Acquisition Summary field (bottom left of screen) shows whether the VOLTS/DIV knob is operating in continuous or stepping mode.

COUPLING

This menu entry button accesses the “Coupling” menus (see next section).

Coupling

COUPLING

Press  to select a coupling level that adapts the oscilloscope's input impedance to the impedance of the device under test. This button also accesses the menus that let you select the

- coupling and grounding of each input channel
- ECL or TTL gain, offset, and coupling that have been preset for the channel shown
- bandwidth limit for all channels
- probe attenuation of each input channel

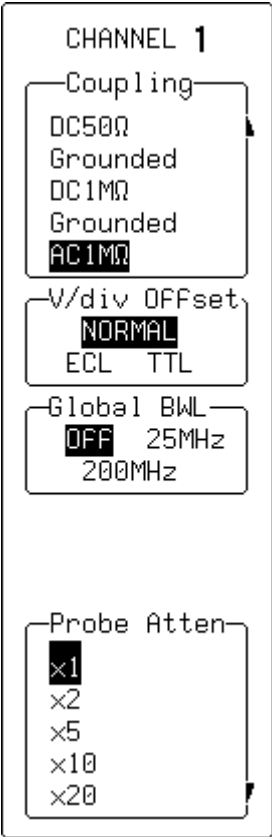

Coupling

This function selects the input channel's coupling. If an overload is detected, the instrument will automatically set the channel to the grounded state. You can then reset the menu to the desired coupling.

V/Div Offset

When NORMAL is highlighted, pressing the corresponding menu button sets the offset, Volts/div, and input coupling to display ECL signals. Press the button a second time to display the settings for TTL signals. Press the button a third time to return the settings to those used during the last manual setup of the channel.

Global BWL/BWL

This function turns the bandwidth limit Off or selects a limit. The bandwidth can be reduced from the maximum to either 200 MHz or 25 MHz, or 30 MHz (-3dB), depending on the model (see Appendix A). Bandwidth limiting is useful for reducing signal and system noise or preventing high-frequency aliasing, reducing any high-frequency signals that may cause aliasing in single-shot applications, for example. This menu is titled "Global BWL" if the Global BWL is activated; that is, the limit that you set will apply to all channels. When a limit can be set individually for each channel, it appears as



CHANNELS, Coupling, and Probes

“BWL” if the Global BWL is deactivated. See Chapter 12, “Special Modes.”

Probe Atten

This function sets the probe attenuation for the input channel. (See the following section for probe details.)

Notes on Coupling:

- *In the AC position signals are coupled capacitively, thus blocking the input signal's DC component and limiting signal frequencies below 10 Hz.*
- *In the DC position all signal frequency components are allowed to pass through, and 1 M Ω or 50 Ω can be selected as the input impedance.*
- *The maximum dissipation into 50 Ω is 0.5 W. Whenever this maximum is reached*
 - *inputs will automatically be grounded*
 - *an overload message will be displayed in the Acquisition Summary field*
 - *the overload condition can be reset by removing the signal from the input and again selecting the 50 Ω input impedance from the menu*
 - *“Grounded” will be highlighted in the “Coupling” menu*

Probes and Probe Calibration



LeCroy PP005 passive probe

Calibrate the passive probe supplied with the oscilloscope as follows (see also the separate instruction sheet provided with the probe):

1. Turn on the oscilloscope.
2. If you are using the HF-compensation ground lead, insert the lead's pins into the probe head, and connect the probe to one of the input channels/BNC connectors.
3. Attach the lead's alligator clip to the CAL BNC's ground (outer ring) and touch the tip to its inner conductor.

Alternatively, if you are using the 11-cm ground lead, attach the supplied BNC adapter to the CAL BNC, and insert the probe tip into the adapter after connecting the probe to an input channel.

The CAL signal in both cases will be a 1-kHz square wave, 1 V p-p

4. Set the channel coupling to DC 1 M Ω , using the "Coupling" menu. Then press the TRACE ON/OFF button to activate the desired trace.

AUTO
SETUP

5. Press  to set up the oscilloscope.

If the displayed signal is overshoot or undershot, you can adjust the probe by inserting the small screwdriver supplied with the probe package into the trimmer on the probe's barrel and turning it clockwise or counterclockwise to achieve the optimal square wave.

ProBus® Probe System

LeCroy's ProBus system provides a complete measurement solution from probe tip to oscilloscope display. This intelligent interconnection between LeCroy oscilloscopes and a wide range of accessories is achieved using a bus that follows Philips' I²C

CHANNELS, Coupling, and Probes

Illustrated at right: a LeCroy current probe with ProBus connection.



protocol. ProBus offers important advantages over standard BNC and probe-ring connections.

For example, the system ensures correct input coupling by auto-sensing the probe type, thus eliminating the guesswork and errors that occur when attenuation or amplification factors are set manually.

ProBus also allows control of transparent gain and offset from the front panel, particularly useful for FET and current probes. It uploads Gain and offset correction factors from the ProBus EPROMS on FET probes, automatically compensating to achieve fully-calibrated measurements.

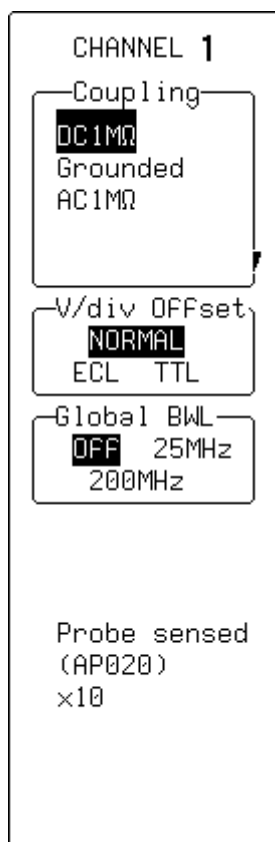

Coupling

This function is used to select the input channel's coupling. If an overload is detected, the instrument will automatically set the channel to the grounded state. The menu can then be reset to the desired coupling.

V/DIV Offset

When NORMAL is highlighted, pressing the corresponding menu button sets the offset, Volts/div, and input coupling to display ECL signals. Press the button a second time and the settings for TTL signals are given. And a third time returns the settings to those used at the last manual setup of the channel.

Global BWL/BWL

Use this function to turn off the bandwidth limit or to select a limit. The bandwidth can be reduced from the maximum to either 200 MHz or 25 MHz, or 30 MHz (-3dB), depending on your LC model (see Appendix A). Bandwidth limiting is useful for reducing signal and system noise or preventing high-frequency aliasing, reducing any high-frequency signals that may cause aliasing in single-shot applications, for example. This menu appears as "Global BWL" if the Global BWL is activated; that is, the limit that you set applies to all channels. When a limit can be set individually for each

channel, it appears as “BWL” if the Global BWL is deactivated. See Chapter 12, “Special Modes.”

- When a FET probe is used, “Probe sensed...” appears automatically. When other ProBus probes are used, this is redefined.

#



CHANNELS, Coupling, and Probes

BLANK PAGE

TIMEBASE + TRIGGER Controls

These controls let you adjust time/division, trigger level and delay; and to access the “TIMEBASE” and “TRIGGER” menu groups. See Chapter 7 for descriptions of the Timebase Modes that are affected by these controls. See Chapter 8 for trigger details.

STOP

This button halts the acquisition in any of the three re-arming modes: AUTO, NORMAL or SINGLE.

- Press the STOP button to prevent the oscilloscope from acquiring a new signal.
- If you press STOP while a single-shot acquisition is in process, the last acquired signal is kept.
- If you press STOP after an RIS acquisition has started, the acquisition is halted, and a partial waveform reconstruction is done.

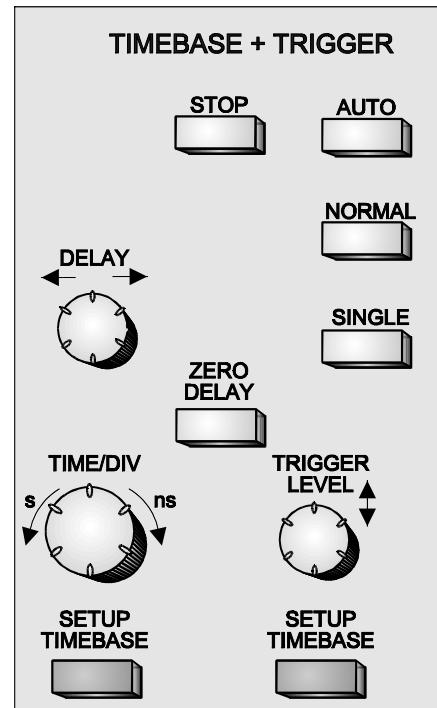

- If you press STOP when the acquisition is in Roll Mode, the incomplete acquisition data is shown as if a trigger had occurred. (**LC584 AND LC684 SERIES**. You can turn on zoom expansions after pressing STOP.) In Sequence Mode, pressing STOP stops the timebase and shows all new segments.

AUTO

Press this button to place the instrument in Auto Mode: the scope automatically displays the signal if no trigger quickly occurs.

- If a trigger does occur within this time, the oscilloscope behaves as in Normal Mode.
- If you press AUTO in RIS Mode, the instrument ends the acquisition and displays it each second (some required segments may be missing).
- If you press AUTO in Roll Mode, the oscilloscope samples the input signals continuously and indefinitely. The acquisition has no trigger, but you can stop it whenever you desire.
- If you press AUTO in Sequence Mode, the acquisition ends if the time between two consecutive triggers exceeds some selectable timeout. The next acquisition then starts from Segment 1. (See Chapter 12, “Special Modes.”)

NORMAL

Press this button to continuously update the screen while a valid trigger is present. If there is no valid trigger, the instrument preserves the last signal, and displays the warning “SLOW TRIGGER” in the Trigger Status Field.

- If you press NORMAL in Roll Mode, the acquisition ends when the last needed data after a trigger have been taken. The display pauses to show the entire waveform. It then goes back into Roll Mode while it waits for the next trigger.
- If you press NORMAL in Sequence Mode, the acquisition ends after the last segment is acquired. The next acquisition starts immediately. Sequence WRAP in Normal is the same as in Single-Shot Mode.

SINGLE

Press this button to place the instrument in Single-Shot Mode, where it waits for a single trigger to occur, then displays the signal and stops acquiring. If no trigger occurs, you can press the button again to see the signal without a trigger.

- If you press SINGLE in RIS Mode, the instrument waits for all the trigger events needed to build one signal before it stops. As many as 4000 trigger events may be required.
- Single-Shot Roll Mode behavior is the same as standard Single-Shot behavior but without the need to press the button a second time to display the signal. However, you can press the button again to end the acquisition with the current available data.

DELAY

This knob adjusts the pre- or post-trigger delay. Pre-trigger adjustment is available from zero to 100% of the full time scale in increments of 1%. The pre-trigger delay is illustrated by the vertical arrow symbol at the bottom of the grid. Post-trigger adjustment is available from 0 to 10 000 divisions in increments of 0.1 division. Labeled in units of seconds, the post-trigger-delay value is displayed in the Trigger Delay field.

ZERO DELAY

This button sets the trigger delay at zero, the trigger instant at the left-hand edge of the grid.

TIME/DIV

This knob selects the time per division in a 1–2–5 sequence. The time/div setting is displayed in the Acquisition Summary field.

TRIGGER LEVEL

This knob adjusts the trigger threshold. The amplitude of trigger signals and the range of trigger levels is limited:

- ± 5 screen divisions with a channel as the trigger source
- ± 0.5 V or ± 1.2 V (**LC564, LC584, AND LC684 SERIES**) with EXT as the trigger source
- ± 5 V with EXT/10, or ± 6 V with EXT/5 (**LC564 AND LC584 SERIES**) as the trigger source
- inactive with Line as the trigger source

Trigger sensitivity is better than one-third screen division.



TIMEBASE + TRIGGER

SETUP TIMEBASE

This menu entry button calls up the “TIMEBASE” menus (described in the next chapter).

SETUP TRIGGER

This menu entry button calls up “TRIGGER SETUP” menus (described in Chapter 8).

#

Timebase Sampling Modes

Depending on the timebase, you may choose from three sampling modes: **Single-Shot**, **RIS (Random Interleaved Sampling)**, or **Roll mode**. Furthermore, for timebases suitable for **Single-Shot** or **Roll mode**, the acquisition memory can be subdivided into user-defined segments to give **Sequence mode**.

Single-Shot

Single-Shot is the digital storage oscilloscope's basic acquisition method.

An acquired waveform is a series of measured voltage values sampled at a uniform rate from the input signal. In Single-Shot mode, this acquisition is a series of measured data values associated with a single trigger event. Acquisition is typically stopped at a fixed time after the event. This fixed time is determined by the trigger delay, and is measured by the timebase clock. The horizontal position of a waveform is determined by using the trigger event to define time zero.

Because each of the oscilloscope's channels has one or more ADCs, the voltage on every input channel is sampled and measured at the same instant. This allows very reliable time measurements among the different channels.

You can set the trigger delay anywhere within a range that allows the waveform to be sampled from well before the trigger event up to the moment it occurs (100% pre-trigger). Alternatively, the waveform can be sampled at the equivalent of 10 000 divisions — the current time/div (post-trigger).

For fast timebase settings, the maximum Single-Shot sampling rate is used, with higher sampling rates achieved by combining channels (see page 7–5). For slower timebases, the sampling rate is decreased, but the number of data samples remains the same. (See Appendix A for specifications.)



Timebase Modes and Setup

Peak Detect

**NOT AVAILABLE ON
LC564, LC584, OR LC684
SERIES**

With slow timebases, sample rate decreases and very short events such as glitches can be missed if they occur between samples. To avoid this special circuitry called Peak Detect can capture the signal envelope to a resolution of 2.5 ns. This does not, however, destroy underlying simultaneously captured data on which advanced processing can still be performed. (See menus on page 7–6.)

RIS: Random Interleaved Sampling

Random Interleaved Sampling (RIS) is an acquisition technique that allows effective sampling rates higher than the maximum single-shot sampling rate. It is used on repetitive waveforms with a stable trigger. The oscilloscope's maximum effective sampling rate of 10 GS/s (25 GS/s for **LC564, LC584, AND LC684 SERIES**) can be achieved with RIS by acquiring 20 single-shot acquisitions (bins) at 500 MS/s. These bins are positioned approximately 0.1 ns apart (40 ps on **LC564, LC584, AND LC684 SERIES**). The process of acquiring the bins and satisfying the time constraint is a random one. The relative time between ADC sampling instants and the event trigger provides the necessary variation, measured by the timebase to 10-ps (5 ps for **LC684 SERIES**) resolution.

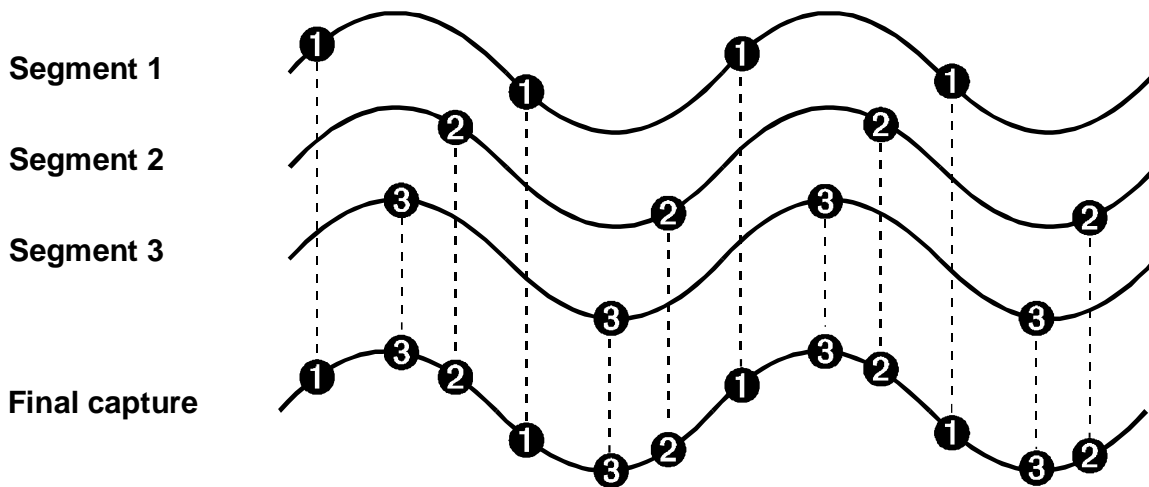

Buildup of an RIS waveform.

On average, 104 trigger events are needed to complete an RIS acquisition. But sometimes many more are needed. These segments are interleaved to provide a waveform that covers a time interval that is a multiple of the maximum single-shot sampling rate. However, the real-time interval over which the waveform data are collected is much longer, and depends on the trigger rate and the desired level of interleaving. The oscilloscope is capable of acquiring approximately 40 000 RIS segments per second.

Roll (Real-Time Display) Incoming points in single-shot acquisitions that have a sufficiently low data rate can be displayed in real time, using Roll mode. On all models at timebase settings ≥ 0.5 s/div (≥ 10 s/div for traces of 500 000 points or more* on all models except the **LC564, LC584, AND LC684 SERIES**) the oscilloscope rolls the incoming data continuously across the screen until a trigger event is detected and the acquisition is complete. This works in the same way as a strip-chart recorder: the latest data is used to update the trace display. Waveform Math and Parameter calculations are performed on the completed waveforms, after the real-time display has stopped.

Sequence Mode In Sequence mode, the complete waveform consists of a number of fixed segments acquired in Single-Shot mode (see Appendix A for the limits). You can determine the number of segments to be acquired, and each segment can be individually selected and used in processing.

Sequence mode offers a number of unique capabilities. Deadtime between trigger events for consecutive segments can be kept to under $50 \mu\text{s}$, in contrast to the millisecond or even longer time intervals normally found between consecutive single-shot waveforms. Complicated sequences of events over large time intervals can be captured in fine detail, while the uninteresting periods between the events are ignored. And time measurements can be made between events on selected segments using the full precision of the acquisition timebase.

* Even when real-time display is not possible, the data will continue to be acquired.



Timebase Modes and Setup

Trigger time stamps are given for each of the segments, using the “Text & Times Status” menu (see Chapter 16). Each individual segment can be zoomed or used as input to math functions (see Chapter 10).

The timebase setting in Sequence mode is used to determine the acquisition duration of each segment: 10 x time/div. This setting, along with the desired number of segments, maximum segment length, and total available memory are used to determine the actual number of samples or segments, and time or points. However, the display of the complete waveform with all its segments may not entirely fill the screen.





Sequence mode can also be used in remote operation to take full advantage of the scope’s high data-transmission capability, overlapping the transmission of one waveform with its successor’s acquisition (see the Remote Control Manual for details).

Wrap

**NOT AVAILABLE ON
LC564, LC584, OR LC684
SERIES**

Sequence mode is normally used for the acquisition of a desired number of segments, after which the waveform acquisition is automatically terminated. However, segments can also be acquired continuously in Sequence mode, using Wrap, with the oldest segments progressively overwritten by new segments in a first in-first out sequence. A manual STOP order or timeout condition is then used to terminate the acquisition (for more on Sequence and Wrap behavior, see page 7–11).

STOP AUTO NORMAL SINGLE

Note: The behavior of *STOP*, *AUTO*, *NORMAL*, and *SINGLE* is modified in both Roll and Sequence modes (refer to the previous chapter and page 7–11).

Sequence Mode: To ensure low deadtime between segments, you must avoid pushing buttons and turning knobs during the acquisition.

Combining Channels

For fast timebases, interleaving of the oscilloscope's ADCs by the combining of channels greatly boosts both sample rate and memory length.

Pairing Channels

Depending on your scope model, a pair of channels can be combined on channel 2 or 3, with channels 1 and 4 disabled or available only for triggering (see Note). On these paired channels the maximum sampling rate is doubled and the record length is increased by four or five times, depending on the model.

Combining All Channels

Note: (SERIES LC564, LC584 ONLY) Channels are combined to increase sample rate or memory size or both in order to capture and view a signal in all its detail. When combined, those channels (like the EXT BNC input) that are not involved in the combination remain available for triggering, even though they are not displayed. It is preferable to select "Automatic" (not available on LC684 SERIES) to combine channels and have the remaining acquisition channels available for triggering. The channels available for triggering only are indicated by "trig only" in the Acquisition Summary Field.

All channels can be combined on a single, pre-defined channel (**NOT ON LC564 SERIES**), while the others are either disabled or, depending on the model, remain available for triggering only (see Note). The interleaving of ADCs and acquisition memory by combining all four channels achieves up to four times the initial maximum sampling rate, and at least four times the record length.

Models in the **LC334, LC534 LC574,** and **LC684 SERIES** combine channels by means of a simple adapter.

When all channels are combined on a **LC374 SERIES** model, the sampling rate is doubled on Channel 2 and the record length increases fivefold.

MODELS IN THE LC564, LC584 SERIES similarly do not require an adapter. In addition, they can combine their ADCs on any input channel using Auto-Combine mode. In this mode, which is activated by selecting "Automatic" from the "Channel Use" menu (see page 7-7), all available memory is allocated to a single, active displayed channel, provided no other channel is displayed or referenced in the Parameter or Math Setup. If two traces are displayed or referenced, sampling and memory resources will be divided equally between them. If more than two traces are displayed or referenced, the resources will be split equally among all four channels.

See the Maximum Sample Rate and Acquisition Memory table in Appendix A for the specifications for each model.



Timebase Setup

TIMEBASE

SETUP
TIMEBASE

Press  to choose Single-Shot, RIS, or Sequence modes to combine channels and increase sample rate and record length on most models; or use Peak Detect and the external clock, where available.

“TIMEBASE” indicates the number of points acquired, sample rate, and total time span.

LC334, LC374, LC534, LC574, and LC684 SERIES

TIMEBASE
T/div 50 ns
250
samples at
500 MS/s
(2 ns/pt)
For 500 ns

Sampling
Single Shot
RIS

Sample Clock
Internal
ECL OV TTL

Channel Use
4 2
Peak-Detect

Sequence
OFF On Wrap

Record up to
8M
samples

Sampling

For selecting either of the two principal modes of acquisition:

- **Single Shot** displays data collected during successive single-shot acquisitions from the input channels. This mode lets you capture non-recurring or very low repetition-rate events simultaneously on all input channels (see page 7-1).
- **RIS** (Random Interleaved Sampling) achieves a higher effective sampling rate than Single-Shot, provided the input signal is repetitive and the trigger is stable (see page 7-2).

Sample Clock

Use this feature to select **Internal** or external (**ECL**, **OV**, **TTL**) clock modes (see page 7-8).

Channel Use

Use this feature to combine channels or activate Peak Detect mode (refer to page 7-2). Select **4** to combine all input channels, or **2** to combine a pair of channels on both CH 2 and CH 3 (see previous page). **Peak Detect** captures high-speed events (not available on **LC684 SERIES**).

Sequence

Use this feature to turn the Sequence mode on or off, or to select **Wrap** whereby new segments are acquired continuously. With Sequence turned **On**, the corresponding menu knob is used to choose the number of segments (see page 7-10).

Record up to

Use this feature to select the maximum number of samples to be acquired, using the associated menu knob. See Appendix A for model maximums.

LC564 AND LC584 SERIES

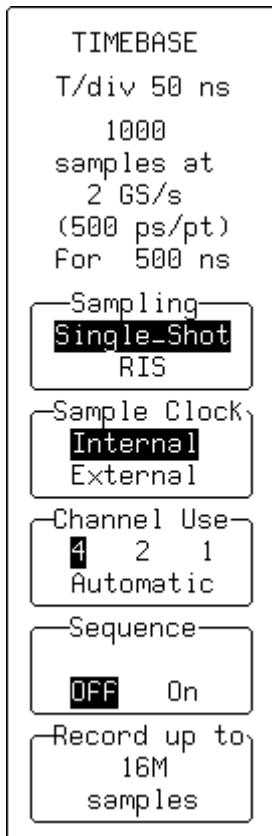

Sampling

Use this feature to select one of the two principal modes of acquisition:

- **Single Shot** displays data collected during successive single-shot acquisitions from the input channels. This mode lets you capture non-recurring or very low repetition-rate events simultaneously on all input channels (see page 7-1).
- **RIS** (Random Interleaved Sampling) achieves a higher effective sampling rate than Single-Shot does, provided the input signal is repetitive and the trigger is stable (see page 7-2).

Sample Clock

This feature selects **Internal** or “external” clock modes (see page 7-9).

Channel Use

Select **4** to activate all input channels, or **2** to combine a pair of channels on both CH 2 and CH 3. Select **1** (**NOT AVAILABLE ON SERIES LC564**) to combine all channels on CH 2 alone. **Automatic** optimizes allocation of sample rate and acquisition memory across the channels: all available resources are allocated to a single displayed channel provided none of the other channels is displayed or referenced in the Parameter or Math Setup. This auto-combine mode is also the best choice when using a remaining acquisition channel for triggering (see page 7-5).

Sequence

This selection turns Sequence mode on or off. When Sequence mode is turned on, the corresponding menu knob is used to choose the number of segments (see page 7-10).

Record up to

This feature selects the maximum number of samples to be acquired, using the associated menu knob. See Appendix A for the maximum number of samples for each model.

LC334, LC374, LC534, LC574 SERIES

TIMEBASE EXTERNAL

These menus appear when an external clock mode (ECL, OV, TTL) is chosen from “Sample Clock”.

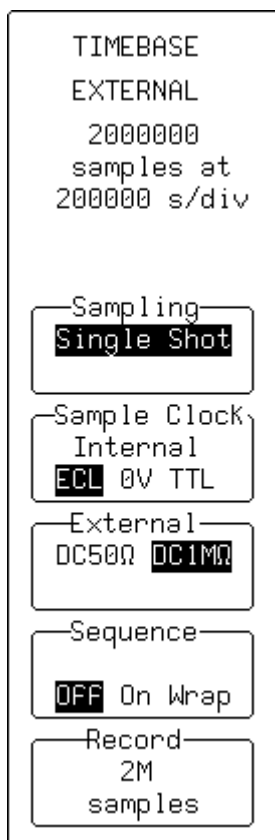

Sampling

This menu is inactive when the external sample clock is being used. **Single-Shot** is selected by default.

Sample Clock

This feature selects a description of the signal applied to the EXT BNC connector for the standard sample clock up to 100 MHz. The rising edge of the signal is used to clock the ADCs of the oscilloscope. The effective thresholds for sampling the input are[†]:

ECL -1.3 V
 OV 0.0 V
 TTL..... +1.5 V

RP (Rear Panel), when shown[‡], specifies that the 50–500 MHz external clock connected to the rear panel is to be used as the sample clock.

External

This feature selects the input coupling for the external clock signal.

Sequence

This feature turns Sequence mode on or off, or selects **Wrap** to acquire new segments continuously. When Sequence **On** or **Wrap** is selected, the corresponding menu knob is used to choose the number of segments (see page 7–10). Neither trigger time stamps nor the AUTO sequence time-out feature are available when external clock is used, nor is intersegment dead time guaranteed.

Record

This feature selects the maximum number of samples to be acquired, using the associated menu knob. See Appendix A for the maximum number of samples for each model.

[†] External clock modes are available only if the EXT trigger is not the trigger source.

[‡] With CKTRIG Option only — see that option’s dedicated *Operator’s Manual* (LCXXX-CKTRIG).

LC564, LC584, AND LC684 SERIES

OPTIONAL

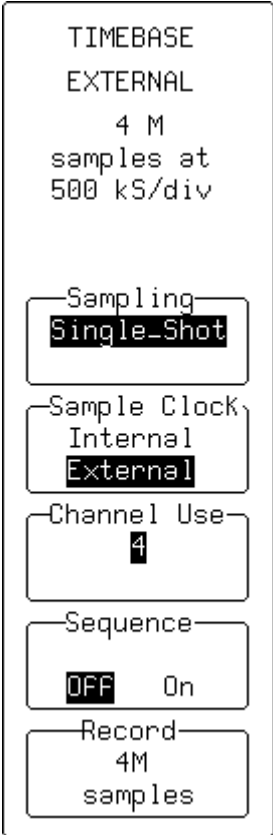

Sampling

This menu is inactive when AN external sample clock is being used. **Single-Shot** is selected by default.

Sample Clock

This feature selects the **External** clock mode. "External" specifies that the DC to 500 MHz external clock, which is connected to the instrument through the rear panel, is to be used as the sample clock. The rising edge of the signal clocks the ADCs. The effective threshold for sampling the input is 0.0 V.

Channel Use

When **External** is selected, 4 channels is the only choice available.

Sequence

This feature turns Sequence mode on or off when new segments are acquired continuously. With Sequence **On**, the corresponding menu knob is used to choose the number of segments (see page 7-10). Neither trigger time stamps nor AUTO sequence time-out feature are available when external clock is used, nor is intersegment dead time guaranteed.

Record

This feature selects the maximum number of samples to be acquired, using the associated menu knob. See Appendix A for the maximum number of samples for each model.

Note: The external clock's time/div is expressed in samples per division, as is the trigger delay, which can be adjusted normally. No attempt is made to measure the time difference between the trigger and the external clock, so successive acquisitions of the same signal can appear to jitter on the screen. The oscilloscope requires a fixed number of pulses (typically 50) to recognize the external clock signal. The acquisition is halted only when the trigger conditions have been satisfied and the appropriate number of data points have been accumulated. Any adjustment to the time/division knob automatically returns the oscilloscope to normal (internal) clock operation.



Timebase Modes and Setup

TIMEBASE — Sequence This is used for Sequence mode.

```
TIMEBASE
T/div 50 ns
100 * 250
samples at
500 MS/s
( 2 ns/pt)
For 500 ns

Sampling
Single Shot

Sample Clock
Internal
ECL OV TTL

Channel Use
4 2
Peak-Detect

Sequence
100 segments
OFF On Wrap

Max. segment
2500
samples
```

Sampling

This menu is inactive when Sequence mode is being used. **Single-Shot** is selected by default.

Sample Clock (OPTIONAL ON LC564 AND LC584 SERIES)

Use this feature to select **Internal** or external (**ECL**, **OV**, **TTL**) clock modes (see page 7–8 or 7–9).

Channel Use

LC334, LC374, LC534, LC574 AND LC684 SERIES: This feature combines channels or activates Peak Detect mode (see page 7–2), on models where these features are available. Select **4** to use all input channels or **2** to combine a pair of channels on both CH 2 and CH 3. **Peak Detect** captures high-speed events (not available on **LC684 SERIES**).

LC564 AND LC584 SERIES ONLY (not shown; see menus on page 7–7). Select **4** to activate all input channels or **2** to combine a pair of channels on both CH 2 and CH 3. Select **1** (**NOT AVAILABLE ON SERIES LC564**) to combine all channels on CH 2 alone. **Automatic** optimizes allocation of sample rate and acquisition memory across the channels: all available resources are allocated to a single displayed channel provided none of the other channels is displayed or referenced in the Parameter or Math Setup. This auto-combine mode is also the best choice when you are using a remaining acquisition channel for triggering (see page 7–5).

Sequence





This feature turns Sequence mode on or off, or selects **Wrap** (if available) to acquire new segments continuously. When **On** or **Wrap** is chosen, the associated menu knob is used to choose the number of segments.

Max. segment

Along with the corresponding button or knob, this feature selects the maximum record length, in samples, for each segment. See *Appendix A for model maximums*.

More on Sequence...

In Sequence mode, pressing each of the TIMEBASE + TRIGGER buttons mentioned here has particular effects on the acquisition.

- When you press  , the oscilloscope fills the chosen number of segments and then stops the acquisition. However, it will not stop until you press  if there are not enough trigger events to fill the segments.
- Press  to fill the segments. When all are filled, the data is processed and displayed. Then, if more trigger events occur, the acquisition will restart from Segment 1.
- In addition, if you press  , when the time between two consecutive triggers exceeds a preselected time-out value, the acquisition restarts from Segment 1. (See Chapter 12, "Special Modes.")

...and Wrap

On models with **Wrap**, the segments can be filled continuously, with the oldest segment overwritten by the newest one, until you press the STOP button. The last n segments are then displayed. Another way to terminate the Wrap sequence is with the AUTO button: the acquisition is stopped when the time between two consecutive triggers exceeds a preselected time-out value.

#



Timebase Modes and Setup

BLANK PAGE

Choosing the Right Trigger

Your oscilloscope offers many distinctive and useful techniques for triggering on, and capturing, data. These range from simple edge trigger to the advanced, multiple-input SMART Trigger®.

Three triggering modes are available: AUTO, NORMAL, and SINGLE. Additionally, STOP lets you cancel the acquisition process at any time. All modes are directly accessible through their respective front-panel buttons.

Modifying Trigger Settings

Make trigger adjustments directly using the front-panel controls and the trigger menus.

This chapter describes triggering operations, and offers hints on how to perform them.

Along with the standard menu descriptions, the schematics show the trigger-menu structure, and the diagrams explain how the main triggers work.

See also the trigger chapters in the “Hands-On Guide”.



Rotate  — for example — to adjust the trigger level of the single trigger source or, for Pattern Trigger, the highlighted trace.

SETUP
TRIGGER

Pressing  gives you access to advanced trigger operations, such as changing the glitch width or the hold-off timeout, which are performed using the TRIGGER SETUP menu group, represented here schematically (Fig. 8-1). Once you have modified the trigger configuration, the changes are stored internally in a non-volatile memory.

See Chapter 6 for more about these and the other trigger controls.

TRIGGER SETUP

Edge

SMART

Figure 8-1. Main Trigger Menus.



Edge or SMART?

A variety of triggers for specific applications can be chosen from the two main trigger groups, Edge and SMART Trigger.

Edge Triggers

In the Edge group of menus, trigger conditions are defined by the vertical trigger level, coupling, and slope. Edge triggers use relatively simple selection criteria to characterize a signal. They are most useful for triggering on simple signals (see next page and page 8–34).

SMART Trigger

The SMART Trigger types allow additional qualifications to be set before a trigger is generated. These qualifications can be used to capture rare phenomena such as glitches or spikes, specific logic states, or missing bits. A qualification might include trigger generation only on a pulse wider or narrower than a user-specified limit. Or it might require — to take another example — three trigger sources exceeding specific levels for a minimum time.

Generally speaking, SMART Trigger offers a variety of trigger qualifications, based on the ability to

- count a specified number of events
- measure time intervals
- recognize a pattern input

SMART explanations start page 8–9 and menus 8–35.

Trigger symbols or icons, examples of which are illustrated throughout this chapter, allow immediate on-screen recognition of the current trigger conditions. There is a symbol for each Edge and SMART Trigger. The more heavily-marked transitions on the symbolic waveform indicate the slope on which the trigger will be generated. And the symbols are annotated by information on the trigger settings.

Edge Trigger



Selecting “Edge” and its menus (Fig. 8–2) causes the scope to trigger whenever the selected signal source meets the trigger conditions. The trigger source is defined by the trigger level, coupling, slope or hold-off. Certain of these basic conditions applicable for SMART Trigger are also selected in “Edge” (see menu descriptions starting on page 8–34).

The symbol above represents an edge trigger, with positive slope — the highlighted edge — defined as the trigger condition.

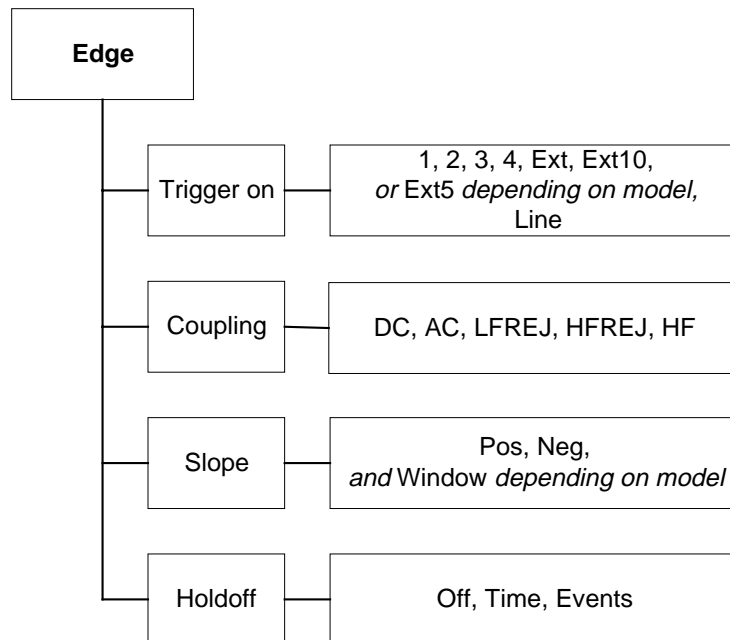

Figure 8–2. Edge Trigger Menus (see page 8–34).



Triggers and When to Use Them

Trigger Source

The trigger source may be one of the following:

- The acquisition channel signal (CH 1, CH 2, CH 3 or CH 4) conditioned for the overall voltage gain, coupling, and bandwidth.
- The line voltage that powers the oscilloscope (LINE). This can be used to provide a stable display of signals synchronous with the power line. Coupling and level are not relevant for this selection.
- The signal applied to the EXT BNC connector (EXT). This can be used to trigger the oscilloscope within a range of ± 0.5 V on EXT and ± 5 V with EXT/10 as the trigger source. Or, on the **LC564, LC584, AND LC684 SERIES**, ± 1.2 V for EXT and ± 6 V with EXT/5 as trigger source.

**AVAILABLE ONLY
ON LC564, LC584 AND
LC684 SERIES**

In addition to the EXT BNC connector, acquisition channels that are not used when channels are combined for greater sample rates or memory can be used for triggering (see Chapter 7, "Combining Channels").

Level

Level defines the source voltage at which the trigger circuit will generate an event (a change in the input signal that satisfies the trigger conditions). The selected trigger level is associated with the chosen trigger source. Note that the trigger level is specified in volts and normally remains unchanged when the vertical gain or offset is modified.

The Amplitude and Range of the trigger level are limited as follows:

- ± 5 screen divisions with a channel as the trigger source
- ± 0.5 V, or ± 1.2 V for the **LC564, LC584, AND LC684 SERIES** with EXT as the trigger source
- ± 5 V with EXT/10, or ± 6 V with EXT/5 as the trigger source on the **LC564, LC584, AND LC684 SERIES**
- none with LINE as the trigger source (zero crossing is used)

Note: Once specified, Trigger Level and Coupling are the only parameters that pass unchanged from trigger mode to trigger mode for each trigger source.

Coupling

This is the particular type of signal coupling at the input of the trigger circuit. As with the trigger level, the coupling can be independently selected for each source. Thus, changing the trigger source can change the coupling. The types of coupling that you can select are:

- **DC:** All the signal's frequency components are coupled to the trigger circuit for high-frequency bursts, or where the use of AC coupling would shift the effective trigger level.
- **AC:** The signal is capacitively coupled, DC levels are rejected and frequencies below 50 Hz attenuated (<10 Hz for the **LC564, LC584, AND LC684 SERIES**).
- **LF REJ:** The signal is coupled through a capacitive high-pass filter network. DC is rejected, and signal frequencies below 50 kHz are attenuated (<100 MHz for the **LC564, LC584, AND LC684 SERIES**). For stable triggering on medium- to high-frequency signals.
- **HF REJ:** Signals are DC-coupled to the trigger circuit. A low-pass filter network attenuates frequencies above 50 kHz. This is used for triggering on low frequencies.
- **HF:** This is to be used only when necessary for triggering on high-frequency repetitive signals >300 MHz, with a maximum trigger frequency of >500 MHz (>1 GHz for the **LC564, LC584, AND LC684 SERIES**). HF is automatically overridden and set to AC when it is incompatible with other trigger characteristics (and SMART Trigger). Only one slope is available.

Slope

Slope determines the direction of the trigger voltage transition that is used to generate a particular trigger event. Like coupling, the selected slope is associated with the chosen trigger source.

Hold-off

Without hold-off, the time between each successive trigger event would be limited only by the input signal, the coupling, and the oscilloscope's bandwidth. However, sometimes a stable display of complex repetitive waveforms can be achieved by placing a condition on this time. This is a hold-off, which can be expressed either as a period of time or an event count. Hold-off disables the trigger circuit for a given period of time, or events (an event is the number of occasions on which the trigger condition is met) after the last trigger occurred. The trigger will again occur when the hold-off has elapsed and the other specified conditions are met. Hold-off is used to obtain a stable trigger for repetitive, composite waveforms. For example, if the number or duration of sub-signals is known, they can be disabled by choosing an appropriate hold-off value.



Triggers and When to Use Them

Hold-off by Time

This is the minimum time between triggers (Fig. 8–3). A trigger is generated when the trigger condition is met after the selected hold-off delay from the last trigger. The timing for the delay is initialized and started on each trigger.

Trigger Source: Positive Slope

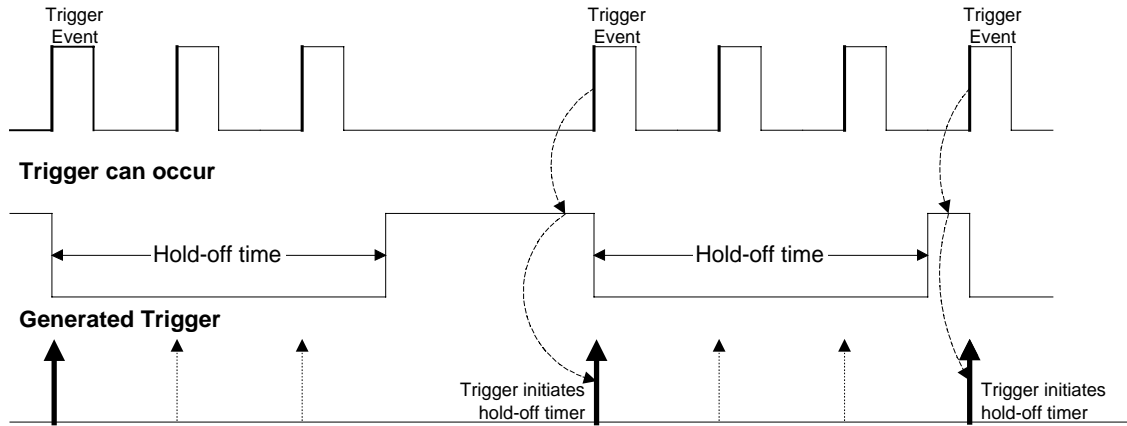

Figure 8–3. Edge Trigger with Hold-off by Time. The bold edges on the trigger source indicate a positive slope. The broken upward-pointing arrows show potential triggers that would occur were other conditions met, while the bold ones show where triggers actually occur when the hold-off time has been exceeded.



This example represents a positive edge trigger level of 0.008 V and a hold-off time of 50 ns.

Hold-off by Events

Hold-off by events is initialized and started on each trigger (Fig. 8–4). A trigger is generated when the trigger condition is met after the selected number of events from the last trigger. An event is defined as the number of times the trigger condition is met after the last trigger. For example, if the number selected is two, as it is in Figure 8–4, the trigger will occur on the third event. From 1 to 99 999 999 events can be selected.

Trigger Source: Positive Slope

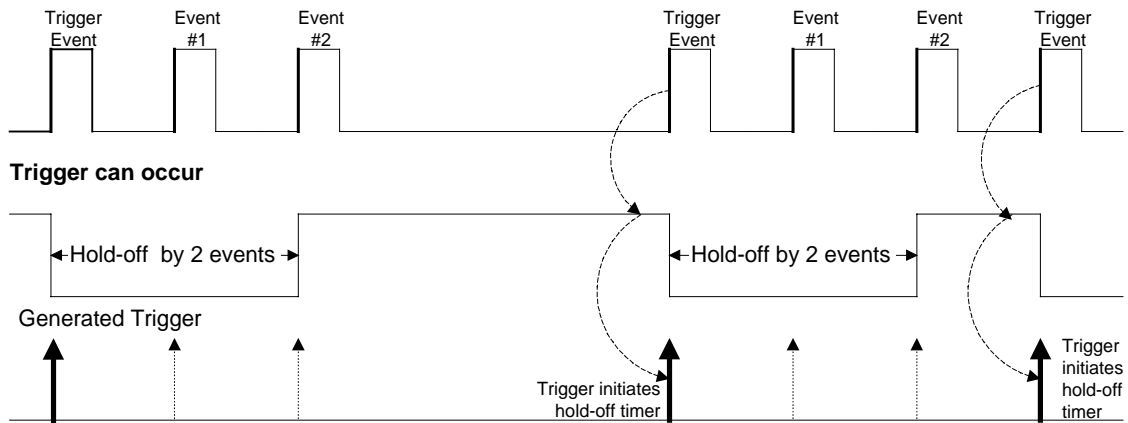

Figure 8–4. Edge Trigger with Hold-off by Events (two events in this example). The bold edges on the trigger source indicate a positive slope. The broken, upward-pointing arrows indicate potential triggers, while the bold ones show where triggers actually occur after the hold-off expires.



This example indicates a hold-off of 37 events.

Triggers and When to Use Them

Window Trigger
AVAILABLE ONLY
ON LC564, LC584, AND
LC684 SERIES

The Window Trigger (Fig. 8–5) allows the definition of a window region whose boundaries extend above and below the selected trigger level. A trigger event occurs when the signal leaves this window region in either direction and passes into the upper or lower region. The next trigger will occur if the signal again passes into the window region. For a trigger to occur, the time that the signal spends within the window must be at least 0.5 ns.

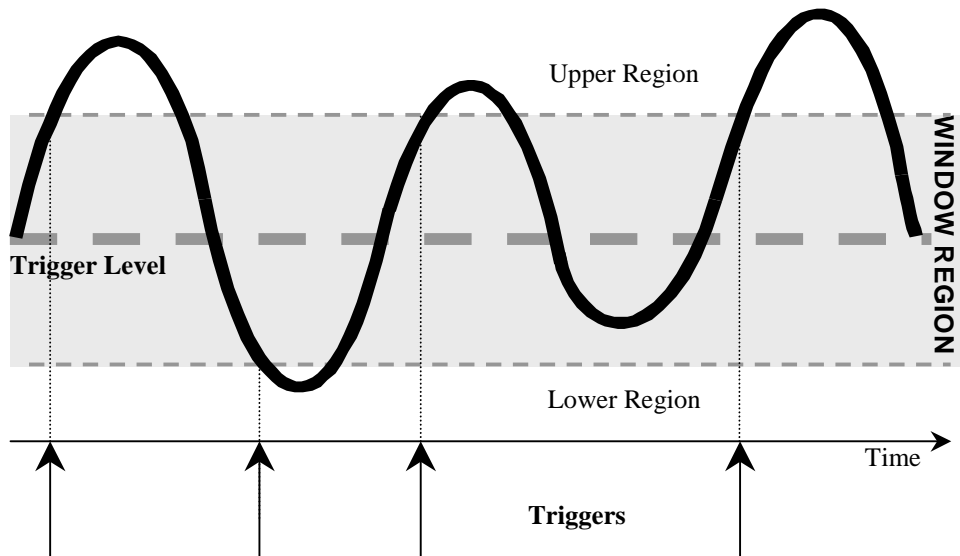

Figure 8–5. Edge Window Trigger: triggers when the signal leaves the window region.



This example shows the trigger level and the range of the window region.

SMART Trigger



SMART Trigger types allow additional qualifications before a trigger is generated. Depending on the oscilloscope model, it may include triggers adapted for glitches, intervals, abnormal signals, TV signals, state- or edge-qualified events, dropouts, patterns, “runs,” and slew rate.

Glitch Trigger

Generally, a glitch is a pulse that is much faster than the observed waveform. Glitch Trigger (*Fig. 8-6*) is used to capture narrow pulses less than or equal to, or greater than or equal to, a given time limit.

The example above shows a pulse width of ≤ 10 ns.

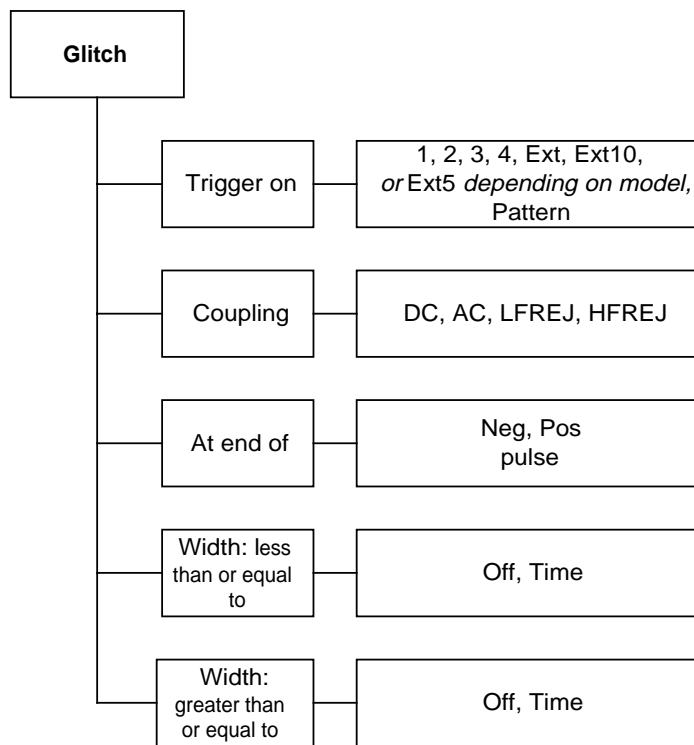

Figure 8-6. Glitch Trigger Menus (see page 8-36).



Triggers and When to Use Them

Glitch Applications

Digital electronics circuits normally use an internal clock. For testing purposes a glitch can be defined as any pulse of width smaller than the clock period or half-period. Glitch Trigger has a broad range of applications in digital and analog electronic development, ATE, EMI, telecommunications, and magnetic media studies.

Pulse Smaller than Selected Pulse Width

This Glitch Trigger selects a maximum pulse width (Fig. 8–7). It is generated on the selected edge when the pulse width is less than or equal to the selected width. The timing for the width is initialized and restarted on the opposite slope to that selected. On the **LC564, LC584, AND LC684 SERIES**, glitches as short as 600 ps can be triggered on, and widths of 600 ps to 20 s can be selected. On the other models, widths of between 2.5 ns and 20 s can be selected, but typically triggering will occur on glitches 1 ns wide.

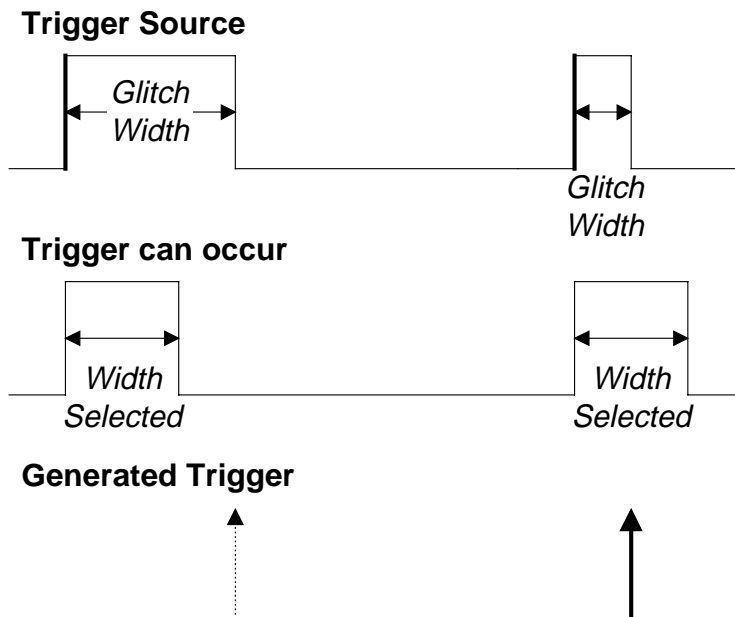

Figure 8–7. Glitch Trigger: here on a pulse width less than or equal to the width selected. The broken upward arrow indicates a potential trigger, while the bold one shows where the actual trigger occurs.

Exclusion Trigger

Selecting “Glitch” and setting width conditions can also enable the exclusion of events that fall in or out of a selected range of width. This is an exclusion trigger (Fig. 8–8). Only pulses outside (less-than-or-equal-to or greater-than-or-equal-to) this range will generate a trigger event. Alternatively, you may decide to trigger only on those pulses in the range itself and exclude all those outside it. The timing for the width is initialized and restarted on the slope opposite the selected edge. Widths of the same values as for Glitch Trigger can be selected (see previous page).

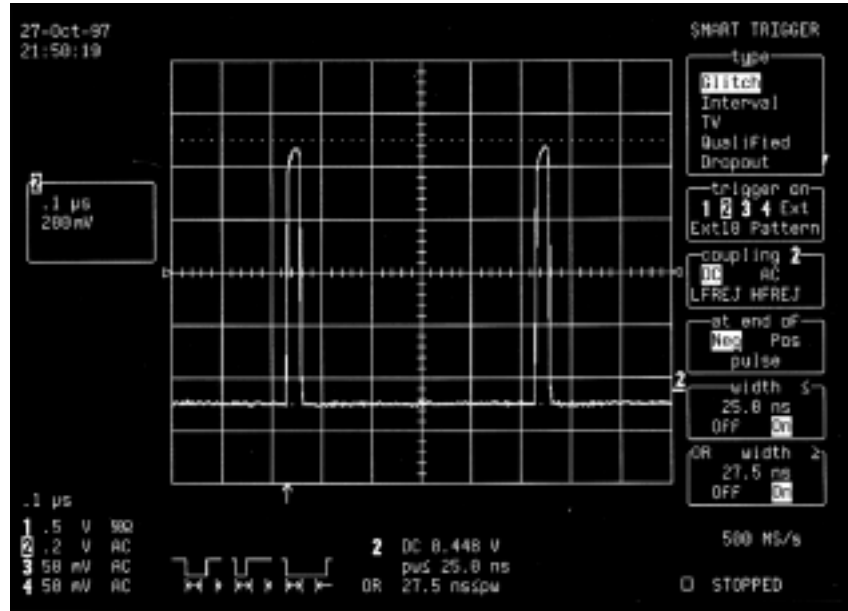

Figure 8–8. Exclusion Trigger. In this example, only pulses outside the boundaries of the width range, those of ≤ 25.0 ns or ≥ 27.5 ns in length, will be captured. Note the “OR” in the “width \geq ” menu, which changes to “&” when triggering only within the range.

Exclusion Applications

Exclusion Triggers allow you to specify a signal's normal width or period. With the scope instructed to ignore the normally shaped signals and trigger only on abnormal ones, it can continuously search for circuit failures.



Triggers and When to Use Them

Interval Trigger

Whereas Glitch Trigger performs over the width of a pulse, Interval Trigger (Fig. 8–9) performs over the width of an interval. An interval corresponds to a the signal duration (the period) separating two consecutive edges of the same polarity: positive to positive edge; negative to negative edge. Interval Trigger captures intervals that are shorter or longer than a given time limit. In addition, a width range can be defined to capture any interval that falls in or out of the specified range — an Exclusion Trigger by Interval.

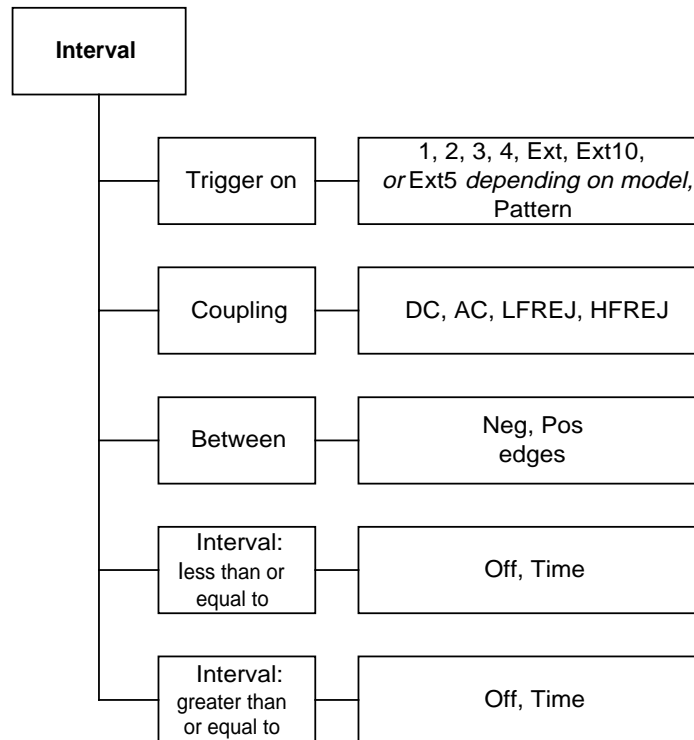

Figure 8–9. Interval Trigger Menus (see page 8–38).

Interval Applications

Interval Trigger is helpful for determining missing cycles or transitions, and for ignoring unwanted signal reflections.

Interval Smaller

For this Interval Trigger, generated on a time interval *smaller* than the one selected, a *maximum* interval between two like edges of the same slope — positive, for example — is chosen (Fig. 8–10). The trigger is generated on the second (positive) edge if it occurs within the selected interval. The timing for the interval is initialized and restarted whenever the selected edge occurs. Intervals of between 10 ns and 20 s (2 ns and 20 s for the **LC564, LC584, AND LC684 SERIES**) can be selected.

Trigger Source: Positive Slope



Trigger can occur



Generated Trigger



Figure 8–10. Interval Trigger that triggers when the interval width is smaller than the selected interval. The broken, upward-pointing arrow indicates a potential trigger, while the bold one shows where the actual trigger occurs — on the positive edge within the selected interval.



This example shows a positive slope and interval of ≤ 1.99 ms selected.

Triggers and When to Use Them

Interval Larger

For this Interval Trigger, generated on an interval *larger* than the one selected, a *minimum* interval between two edges of the same slope is selected (Fig. 8–11). The trigger is generated on the second edge if it occurs after the selected interval. The timing for the interval is initialized and restarted whenever the selected edge occurs. Intervals of between 10 ns and 20 s (2 ns and 20 s for the **LC564, LC584, AND LC684 SERIES**) can be

Trigger Source: Positive Slope

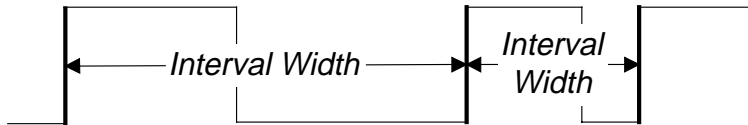

Trigger can occur



Generated Trigger



selected.

Figure 8–11. Interval Trigger that triggers when the interval width is larger than the selected interval. The broken upward-pointing arrow indicates a potential trigger, while the bold one shows where the actual trigger occurs — on the positive edge after the selected interval.

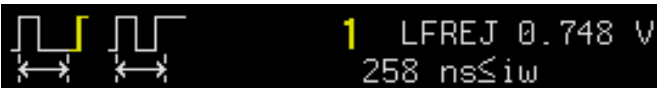

This example shows a positive slope and interval of ≤ 258 ns selected.

Interval Between Range

This Interval Trigger is generated whenever an interval between two edges of the same slope falls within a selected range (Fig. 8–12). The timing for the interval is initialized and restarted whenever the selected edge occurs. Intervals of between 10 ns and 20 s (2 ns and 20 s for the **LC564, LC584, AND LC684 SERIES**) can be selected.

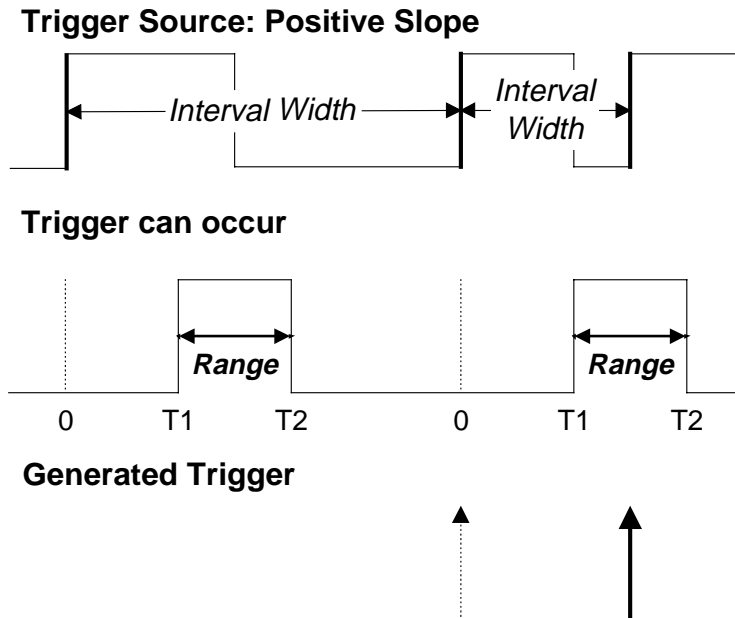

Figure 8–12. Interval Trigger that triggers when the interval falls within the selected range: T1 = the range's lower time limit; T2 = its upper limit. The broken upward-pointing arrow indicates a potential trigger, while the bold one indicates where the actual trigger occurs — on the positive edge within the selected range.



This example shows a positive slope, range limits of ≥ 10.0 ns and ≤ 5.4 μ s, selected.



Triggers and When to Use Them

Interval Outside Range

This Interval Trigger is generated whenever an interval between two edges of the same slope falls outside a selected range (Fig. 8–13). The trigger is generated on the second edge if it occurs after the selected interval range. The timing for the interval is initialized and restarted whenever the selected edge occurs. Intervals of between 10 ns and 20 s (2 ns and 20 s for the **LC564, LC584, AND LC584 SERIES**) can be selected.

Trigger Source: Positive Slope

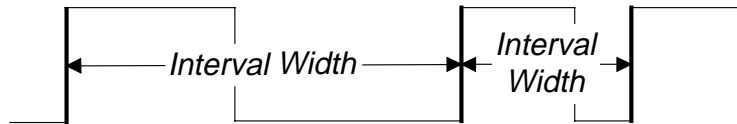

Trigger can occur

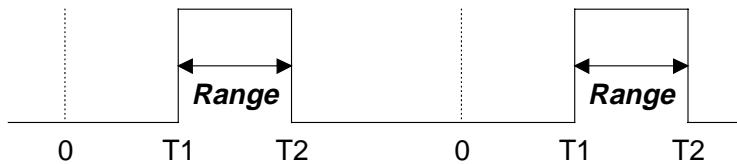

Generated Trigger



Figure 8–13. Interval Trigger that triggers when the interval falls outside the selected range: T1 = the range’s lower time limit; T2 = its upper limit. The broken upward-pointing arrow indicates a potential trigger, while the bold one shows where the actual trigger occurs, on the positive edge outside the selected range.

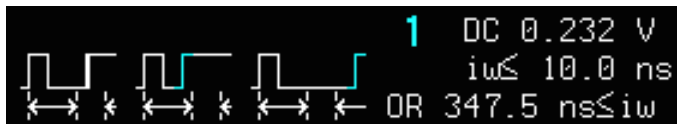

This example shows a positive slope, and range limits of ≤ 10.0 ns and ≥ 347.5 ns selected. “OR” means that intervals above or below the range have been targeted.

Pattern Trigger

Pattern Trigger (Fig. 8–14) enables triggering on a logical combination of the five inputs CH 1, CH 2, CH 3, CH 4 and EXT. This combination, called a pattern, is defined as the logical AND of trigger states. A trigger state is either high or low: high when a trigger source is greater than the trigger level (threshold) and low when less than it (Fig. 8–15). For example, a pattern could be defined as present when the trigger state for CH 1 is high, CH 2 is low, and EXT is irrelevant (X or don't care). If any one of these conditions is not met, the pattern state is considered absent. Hold-off limits from 10 ns to 20 s (2 ns–20 s for the **LC564, LC584, AND LC684 SERIES**) or from 1 to 99 999 999 events can be

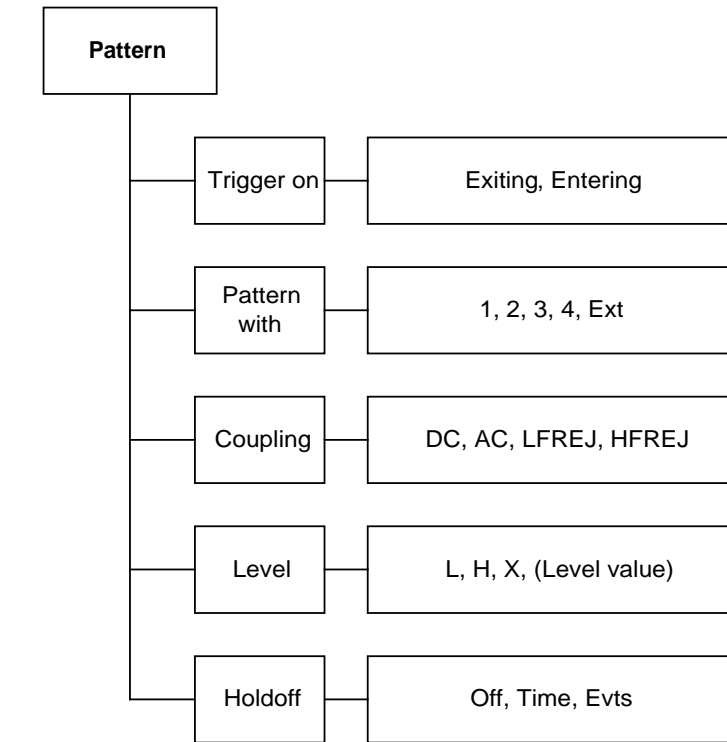

selected.

Figure 8–14. Pattern Trigger Menus (see page 8–43).



Triggers and When to Use Them

Pattern Applications

Pattern Trigger can be used in digital design for the testing of complex logic inputs or data transmission buses.

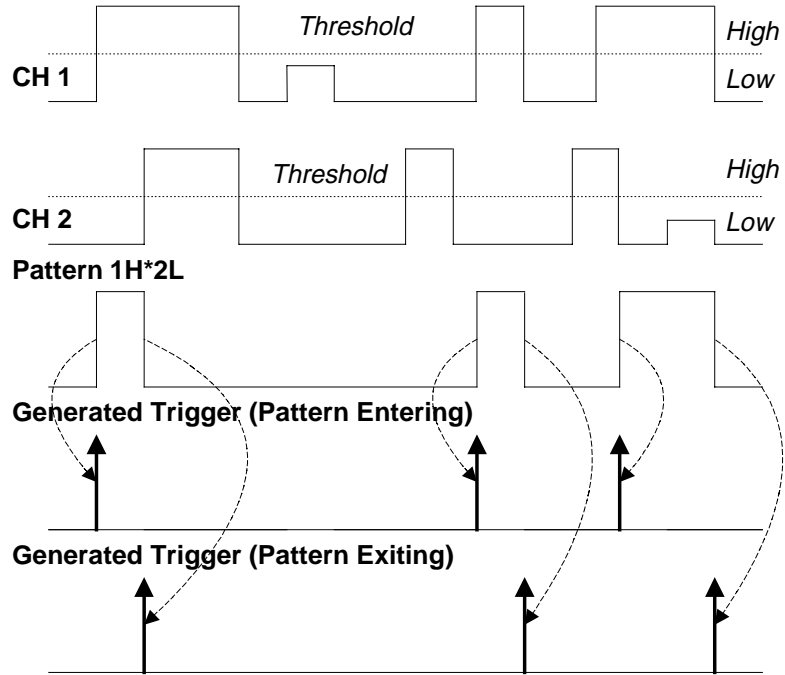

```

Enter 1H*3H*4L*EL    E AC 500mV 1MΩ
1 DC 1.004 V         - - -
3 AC 2.49 V          4 AC 2.50 V
  
```

Figure 8-15. Pattern Trigger: triggers when all pattern conditions are met. Bold, upward-pointing arrows show where triggers occur. Information summarizing the pattern setup is displayed.

More About Pattern Trigger

Once the pattern is defined, one of two transitions can be used to generate the trigger. When the pattern begins, called *entering* the pattern, a trigger can be generated. Alternatively, a trigger can be generated when the pattern ends, called *exiting* the pattern.

With pattern triggering, as in single source, either of these qualifications can be selected: Hold-off for 10 ns up to 20 s (2 ns–20 s for the **LC564, LC584, AND LC684 SERIES**), or Hold-off for 1 to 99 999 999 events.

When set to Pattern Trigger, the oscilloscope always checks the logic AND of the defined input logic states. However, with the help of de Morgan's laws, the pattern becomes far more generalized.

Consider the important example of the Bi-level or Window Pattern Trigger. Bi-level implies the expectation of a single-shot signal on which the amplitude will go in either direction outside a known range. To set up a Bi-level Pattern trigger, connect the signal to two inputs: Channels 1 and 2 or any other pair that can be triggered on. For example, the threshold of CH 1 could be set to +100 mV and that of CH 2 at –200 mV. The Bi-level Trigger will occur if the oscilloscope triggers on CH 1 for any pulse greater than +100 mV, or on CH 2 for any pulse less than –200 mV. For improved precision, the gains of the two channels should be at the same setting.

In Boolean notation we can write:

$$\text{Trigger} = \text{CH 1} + \overline{\text{CH 2}}$$

that is, trigger when entering the pattern CH 1 = high OR CH 2 = low.

By de Morgan's theorem this is equivalent to:

$$\text{Trigger} = \overline{\overline{\text{CH 1}} \cdot \overline{\text{CH 2}}}$$

that is, trigger when exiting the pattern CH 1 = low AND CH 2 = high. This configuration can be easily programmed.

The possibility of setting the threshold individually for each channel extends this method so that it becomes a more general Window Trigger: in order to trigger the input pulse amplitude must lie within or outside a given arbitrary window.

Pattern Trigger has been designed to allow a choice of the trigger point. By choosing *1L*2H entering*, the trigger will occur at the moment the pattern 1L*2H becomes true.



Triggers and When to Use Them

Qualified Triggers

In the case of Qualified Triggers (Fig. 8–16), a signal’s transition above or below a given level — its *validation* — serves as an enabling (qualifying) condition for a second signal that is the source of the trigger.

Two Qualified Triggers are available: State-Qualified, where the amplitude of the first signal must remain in the desired state until the trigger occurs; and Edge-Qualified, for which the validation is sufficient and no additional requirement is placed on the first signal (for the separate, Qualified First Trigger, see page 8–24).

A Qualified Trigger can occur immediately after the validation or within a set time after it. Or it can occur following a predetermined time delay or number of potential trigger events. The time delay or trigger count is restarted with every validation.

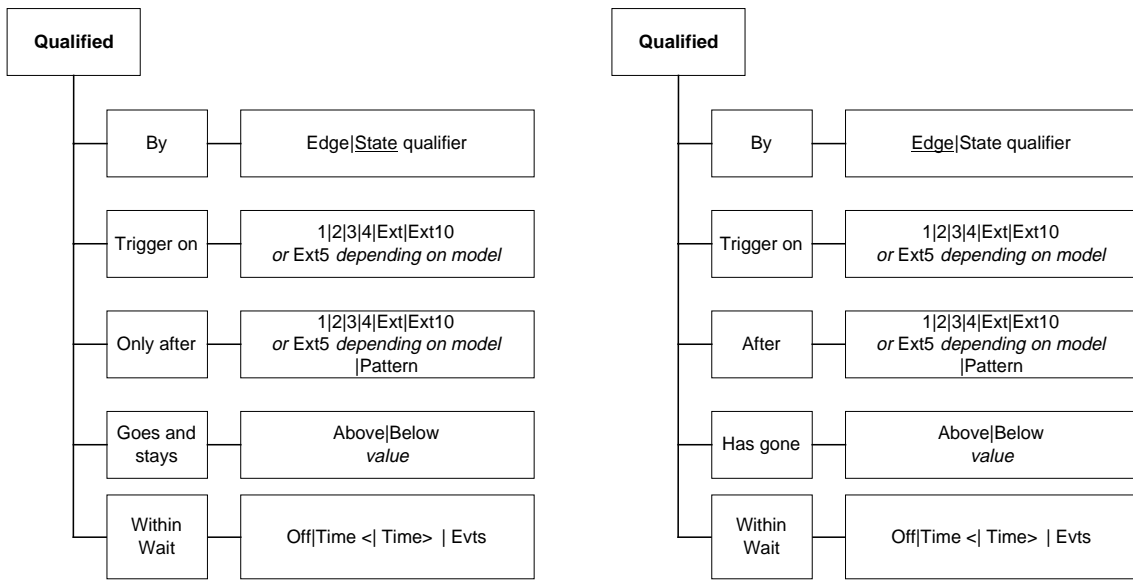

Figure 8–16. State- and Edge-Qualified Trigger Menus (see pages 8–40 and 8–41).

Qualified Triggers offer the choice of generating a trigger when a selected pattern is present or absent. As with Pattern Trigger, the pattern is defined as a logical AND combination of trigger states that are high or low: high when a trigger source is greater than the selected trigger level; low when it is less. For example, a pattern might be defined as present when the trigger states for Channels 1 and 2 are high and EXT is low. If any one of these conditions is not met, the pattern state is considered absent.

Qualified Triggers allow an additional qualification once the selected pattern state occurs. For example: "wait for 10 ns up to 20 s, trigger on CH 1 to the 99 999 999th event." The pattern is used to qualify the trigger without actually generating it. Triggering will occur when another signal, the trigger source, meets its trigger condition while the pattern is present. The trigger source itself is not allowed in the pattern.

Qualified Applications

Typical applications can be found wherever time violations occur, such as in micro-processor debugging, or telecommunications.

State-Qualified with Wait

State-Qualified Trigger with Wait (Fig. 8–17) is determined by the parameters of Time or the number of Events:

- **Time** determines a delay from the start of the desired pattern. After the delay (timeout) and while the pattern is present, a trigger can occur. The timing for the delay is restarted when the selected pattern begins.
- **Events** determines a minimum number of events of the trigger source. An event is generated when a trigger source meets its trigger conditions. On the selected event of the trigger source and while the pattern is present, a trigger can occur. The count is initialized and started whenever the selected pattern begins, and continues while the pattern remains. When the selected count is reached, the trigger occurs.



This example shows a State-Qualified-with-time-Wait trigger: positive slope, 2 ns delay, "goes and stays Above" -24 mV.

Triggers and When to Use Them

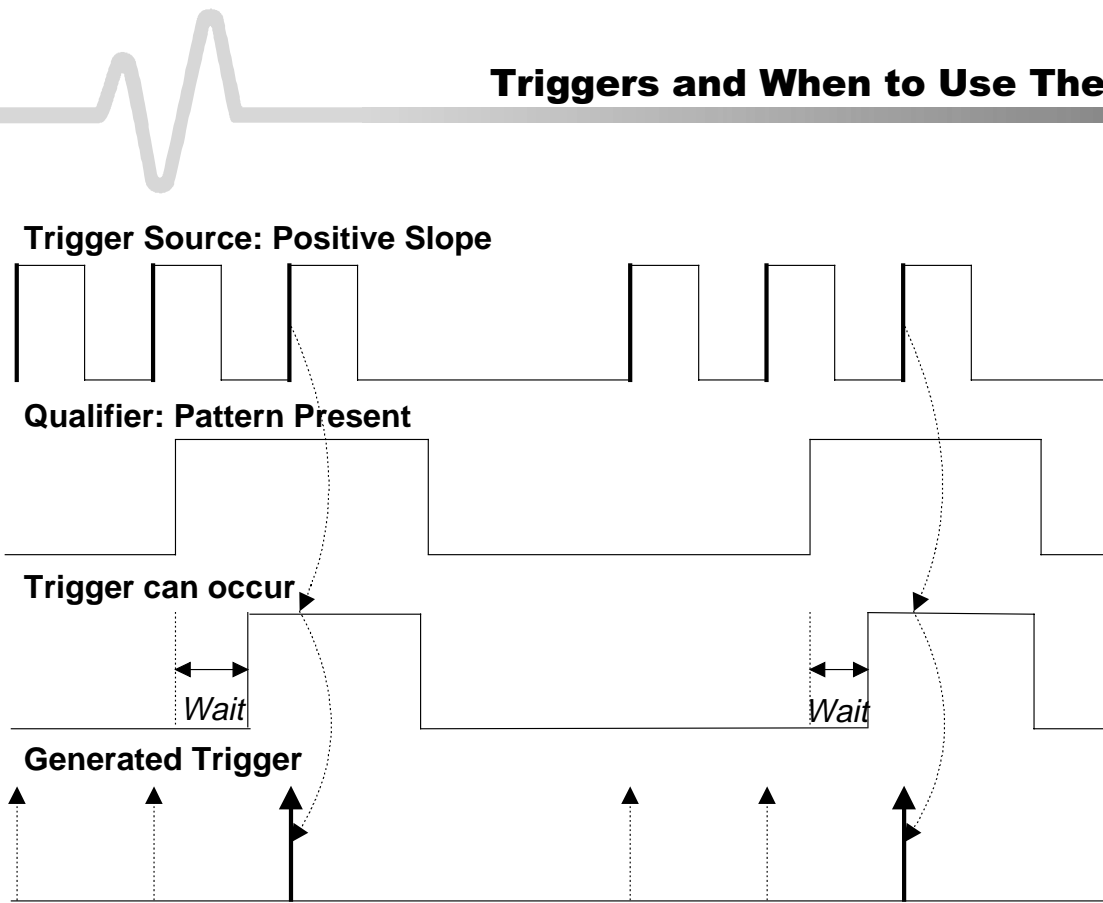
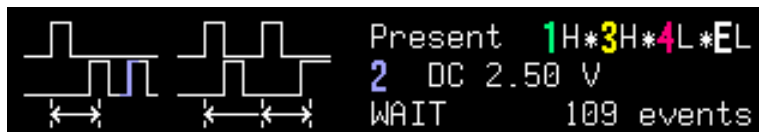

Figure 8–17. State-Qualified by Wait: Trigger after timeout. The broken upward-pointing arrows indicate potential triggers, while the bold arrows show where the actual triggers occurs.

As the above figure illustrates, a trigger is generated on a rising edge whenever the pattern is asserted (pattern present) and the wait timeout has expired. The timeout is activated or disabled once the pattern is asserted or absent, respectively.



This example shows an Edge-Qualified-with-event Wait trigger on CH 2 (described next page): positive slope, wait of 109 events, level of 2.50 V, and pattern present as indicated.

Edge-Qualified with Wait

Like its State-Qualified equivalent, Edge-Qualified with Wait (Fig. 8–18) is conditioned by either Time or Events:

- **Time** determines a delay from the start of the desired pattern. After the delay (timeout) and before the end of the pattern, a trigger can occur. The timing for the delay is restarted when the selected pattern begins.
- **Events** determines a minimum number of events for the trigger source. An event is generated when a trigger source meets its trigger conditions. A trigger can occur on the selected event of the trigger source and before the end of the pattern. The count is initialized and started whenever the selected pattern begins. It continues while the pattern remains. When the selected count is reached, the trigger occurs.

Figure 8–18. Edge-Qualified by Wait: Trigger after timeout. The broken upward-

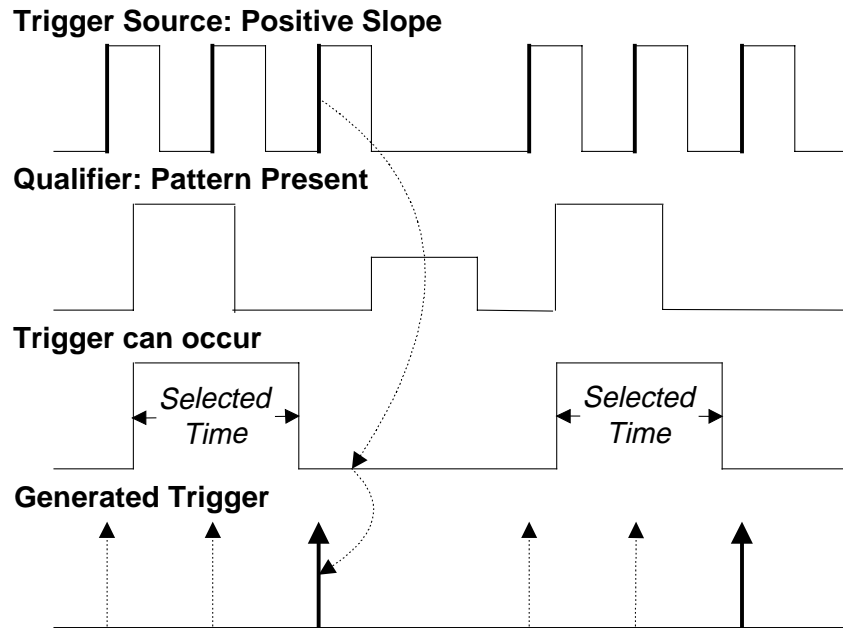

pointing arrows indicate potential triggers, while the bold ones show where the actual trigger occurs.

Qualified First

Qualified First Trigger (Fig. 8–19) is similar to the Qualified Triggers, and presents exactly the same menus (see page 8–44). Qualified First is



Triggers and When to Use Them

intended to be used exclusively in Sequence Mode to speed up the trigger rate. With Qualified First, a single valid trigger is sufficient to acquire a full sequence. Other than in Sequence Mode, Qualified First is identical to the Qualified Triggers.

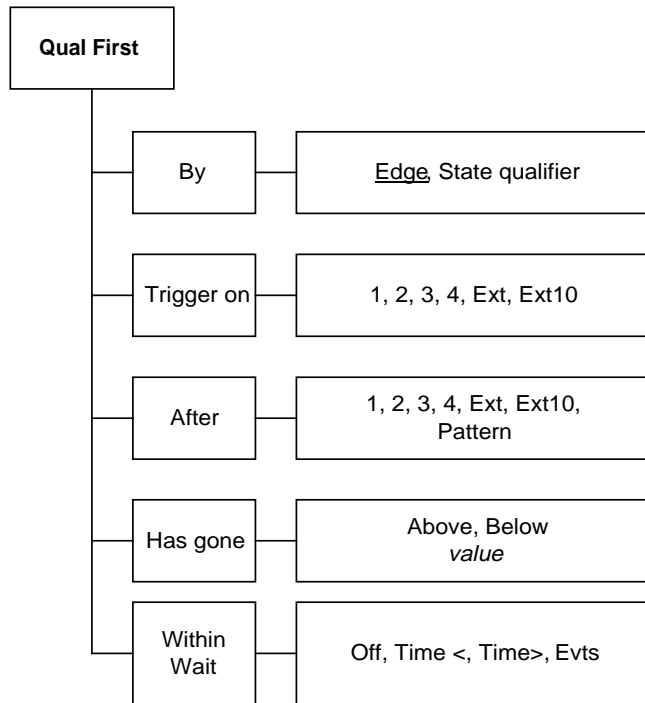

Figure 8-19. Qualified First Trigger Menus (see page 8-44).

Applications

In Data Storage, the index pulse can be defined as the qualifier signal and the servo gate signal as the trigger source.

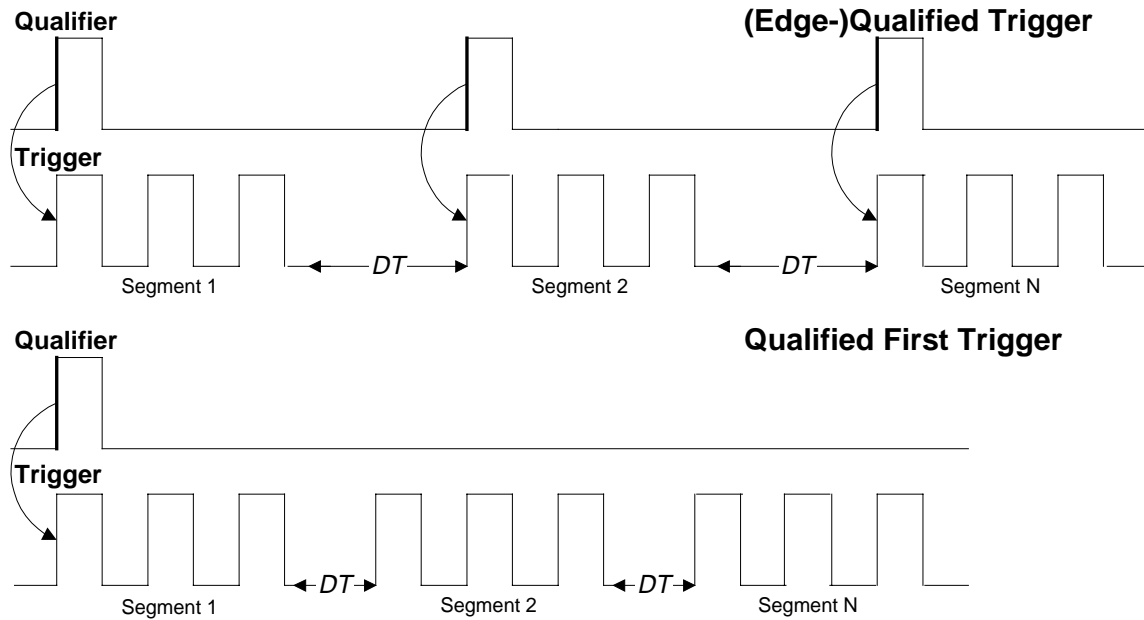

Figure 20. Comparing Qualified (top) and Qualified First (bottom) Triggers. Whereas the (Edge-) Qualified Trigger requires that each of the segments be “qualified” by a valid condition in Sequence Mode, Qualified First Trigger needs only a single valid condition to qualify a full sequence of segments. Note that the inter-segment deadtime (DT) is much shorter with Qualified First, which is used only in Sequence Mode.



This example shows Qualified First Trigger.

Triggers and When to Use Them

TV Trigger

A special kind of Edge-Qualified Trigger, TV Trigger (Fig. 8–21) allows stable triggering on standard or user-defined composite video signals, on a specific line of a numerically odd or even field. TV Trigger can be used on PAL, SECAM, or NTSC systems.

A composite video signal on the trigger input is analyzed to provide a signal for the beginning of the chosen field — “any”, “odd” or “even” — and for a signal at the beginning of each line. The field signal provides the starting transition, and the beginnings of line pulses are counted to allow the final trigger on the chosen line. Each field, the number of fields, the field rate, interlace factor, and number of lines per picture must be specified, although there are standard settings for the most common types of TV signals. TV Trigger can also function in a simple any-line mode.

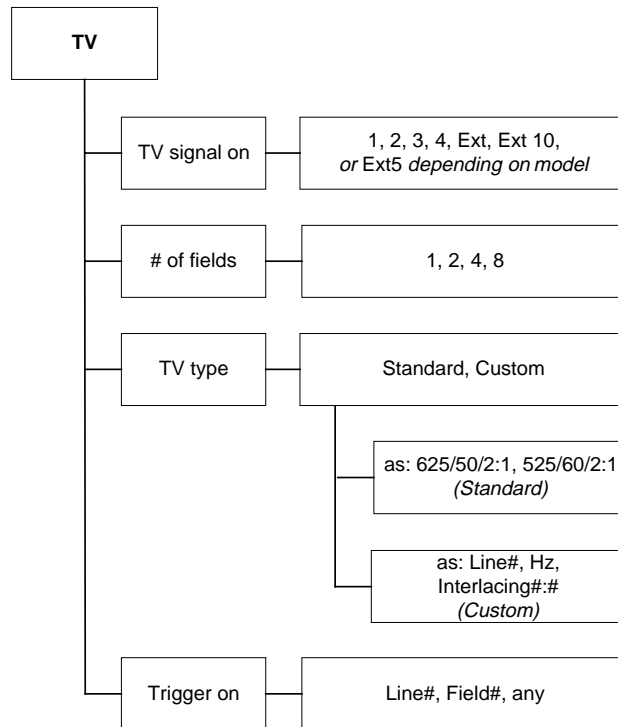

Figure 8–21. TV Trigger Menus (see page 8–39).

Notes for TV Trigger

- *Because most TV systems have more than two fields, the enhanced field-counting capability (FIELDLOCK) allows the oscilloscope to trigger consistently on a chosen line within a field of the signal. The field-numbering system is relative, in that the oscilloscope cannot distinguish between fields 1, 3, 5, or 7 (or 2, 4, 6, or 8) in an absolute way.*
- *For each of the characteristics the following remarks apply:*
 - **625/50/2:1 (PAL and SECAM systems)**

This setting should be used for most of the standard 50-field signals. The lines may be selected in the range 1 to 626 where line 626 is identical to line 1.

Number of fields: “4” is most useful for color PAL signals; “8” for SECAM signals.
 - **525/60/2:1 (NTSC systems)**

This setting should be used for standard 60-field NTSC signals. The lines can be selected in the range 1 to 1051, where line 1051 is identical to line 1.

Number of fields: “4” is most useful for US-type NTSC systems.
 - **?/50/?, ?/60/?**

In order to allow maximum flexibility, no line-counting convention is used. The line count should be thought of as a line-synchronizing pulse count. It includes the transitions of the equalizing pulses. For certain extreme cases, the field transition recognition will no longer work, and only the “any line” mode will be available.
- *The enhanced field-counting capability cannot be used for RIS acquisitions.*
- *Composite video signals must have negative-going synch to be decoded correctly.*

This example TV Trigger shows a trigger on Line 338 of an even field of a PAL/SECAM signal on CH 1. The “25” in parentheses is the number of the line selected in Field 1.

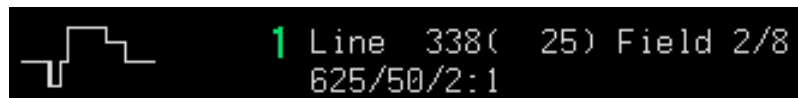



Triggers and When to Use Them

Dropout Trigger

Dropout Trigger (Fig. 8–22) provides triggering whenever the signal disappears for a set period of time. The trigger is generated at the end of the time-out period following the “last” trigger-source transition, as shown in the figure on the next page (Fig. 8–23). Time-outs of between 25 ns and 20 s (2 ns and 20 s for the **LC564, LC584, AND LC684 SERIES**) can be selected.

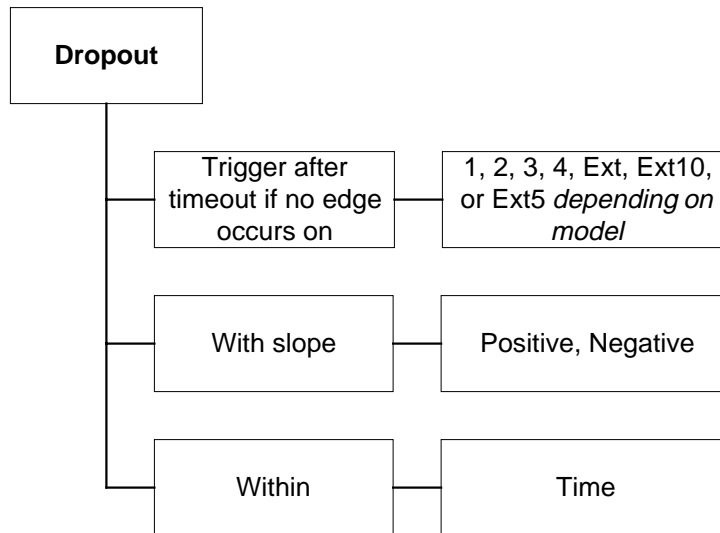

Figure 8–22. Dropout Trigger Menu (see page 8–42)

Dropout Applications

Dropout Trigger is useful for detecting interruptions in data streams such as network hang-ups and microprocessor crashes. A typical application is on the last ‘normal’ interval of a signal that has disappeared completely. This is essentially a single-shot application, usually with a pre-trigger delay. RIS acquisition is not useful here because the timing of the trigger timeout is insufficiently correlated to the input channel signals.

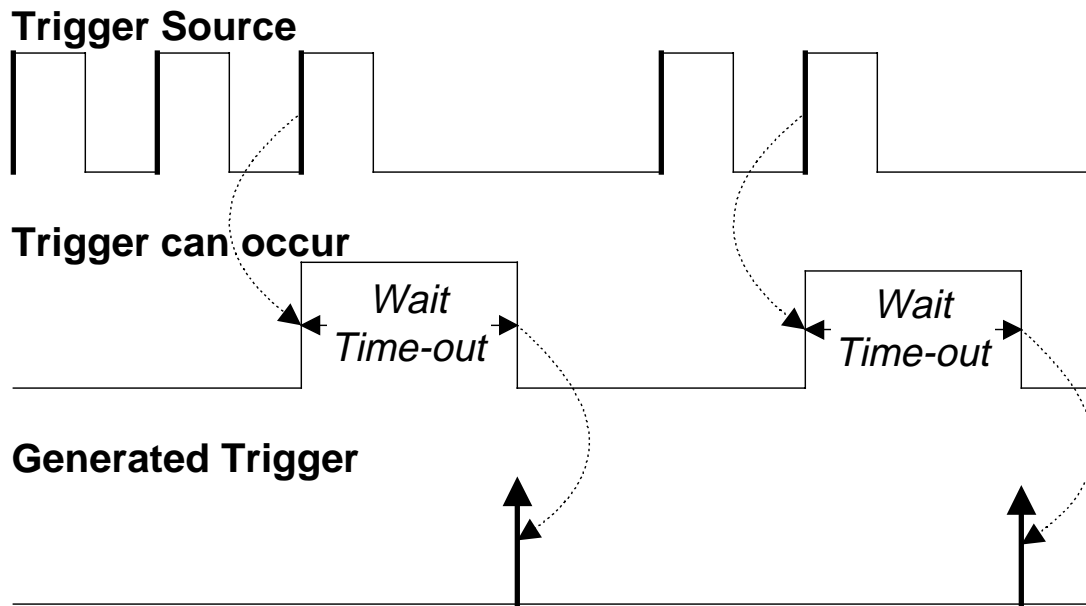

Figure 8–23. Dropout Trigger: occurs when the time-out has expired. The bold upward-pointing arrows show where the trigger occurs.



This Dropout Trigger example shows a wait time-out of 25 ns.



Triggers and When to Use Them

Runt Trigger **AVAILABLE ONLY** **ON LC564, LC584, AND** **LC684 SERIES**

The Runt Trigger (*Fig. 8–24*) is programmed to occur when a pulse crosses a first threshold line and fails to cross a second threshold line before re-crossing the first (*Fig. 8–25*). You can select both thresholds within a range of 600 ps to 20 s. Other defining conditions for this trigger are the edge (triggers on the slope opposite to that selected) and the runt width.

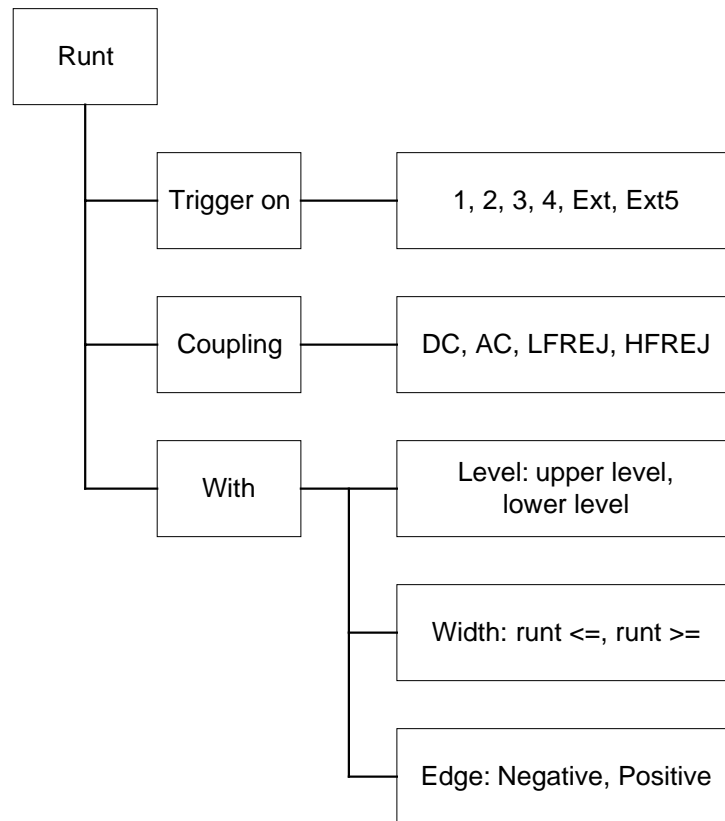

Figure 8–24. Runt Trigger Menus (see page 8–45).

Runt Applications

Runt Trigger is particularly helpful for detecting meta-stable conditions in digital design.

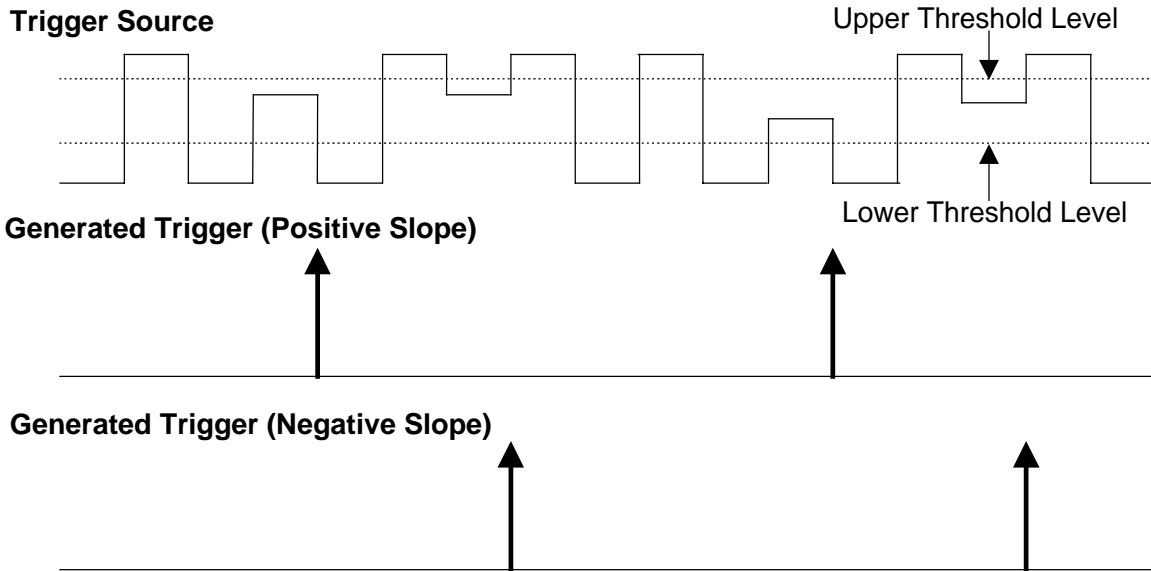
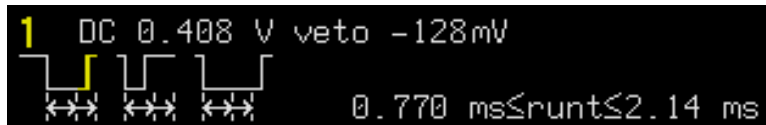

Figure 8–25. Runt Trigger: triggers when a pulse crosses the first threshold but not the second before re-crossing the first — marked by the bold, upward-pointing arrows.



This example shows a positive edge (“Neg” was selected to obtain this), the difference between the two threshold levels (“veto”), and the runt width.



Triggers and When to Use Them

Slew Rate Trigger

**AVAILABLE ONLY ON
LC564, LC584, AND LC684
SERIES**

Slew Rate Trigger (Fig. 8–26) activates a trigger when the *rising or falling edge of a pulse crosses two threshold levels: an upper and a lower level* (Fig. 8–27). The pulse edge must cross the thresholds faster or slower than a selected period of time. You can select both thresholds within a range of 600 ps to 20 s.

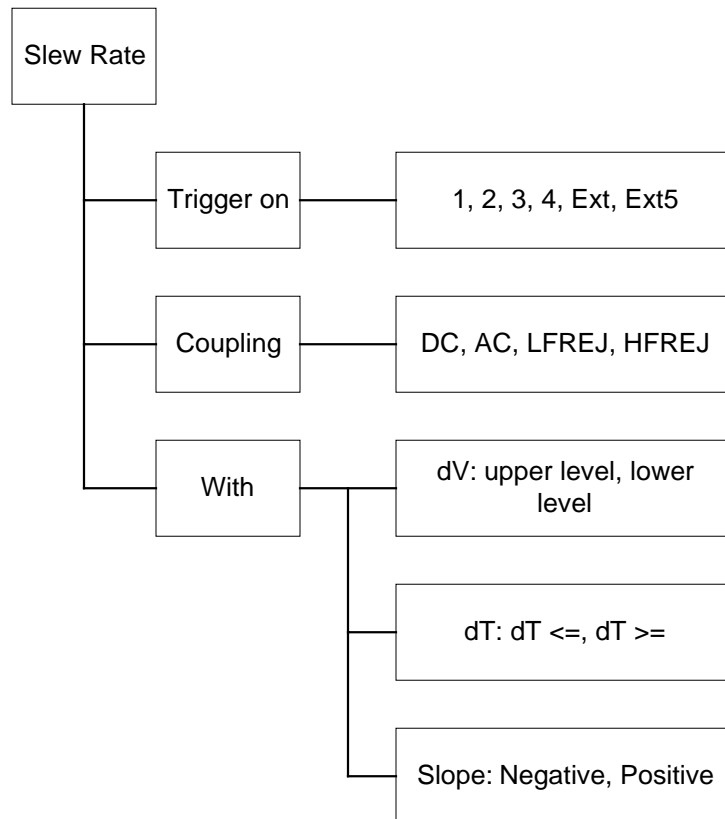

Figure 8–26. Slew Rate Trigger Menus (see page 8–46)

Applications

Slew Rate Trigger is useful for measuring risetime or falltime in digital design, minimizing reflections.

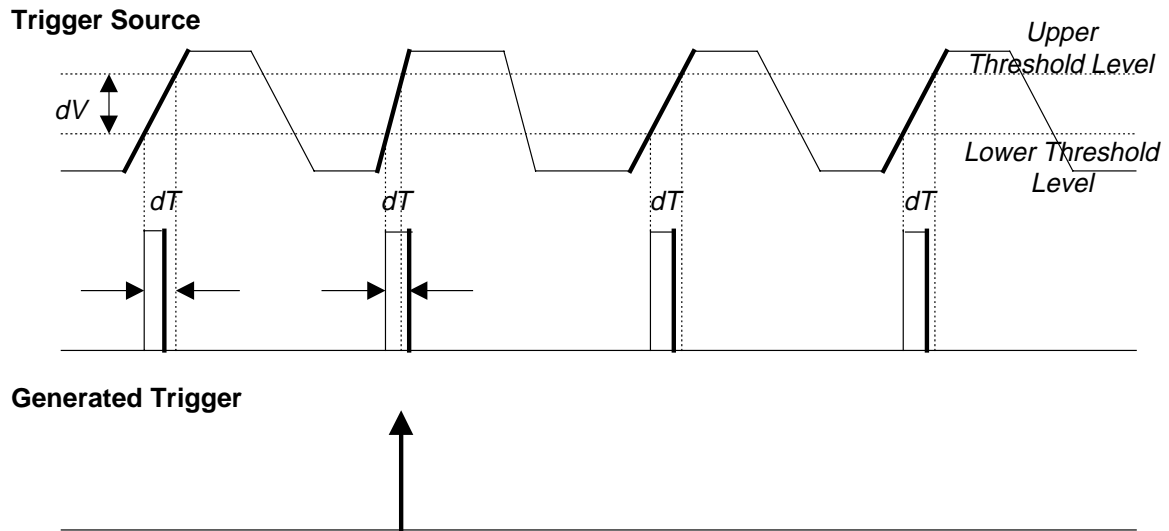

Figure 8–27. Slew Rate Trigger: occurs when a rising or falling edge crosses two thresholds (dV) outside a selected time range (dT), marked by the bold, upward-pointing arrow.

```

1 DC 0.556 V to 188mV
┌ slope >= 73.6 mV/ns

```

This Slew Rate example is the same as the Edge Trigger symbol, but shows lower (0.556 V) and upper (188 m) threshold levels, and a time range (≥ 73.6 ns).



TRIGGER SETUP: Edge

SETUP
TRIGGER

Press  to access selection of:

- Trigger source,
- Coupling for each source,
- Slope (positive or negative), and
- Hold-off by time or events.

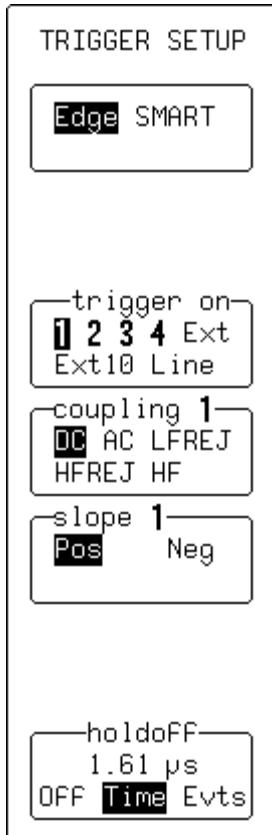

Edge/SMART

Use this to select **Edge** (for an explanation of Edge Trigger, refer to page 8–3).

trigger on

This selects the trigger source.

coupling

This selects the trigger coupling for the current source.

slope

Use this to place the trigger point on the **Pos**-itive or **Neg**-ative slope of the selected source. **LC564, LC584, AND LC684 SERIES ONLY:** This menu also offers **Window**, which allows triggering whenever the input signal exits a specified voltage window (refer to previous page). When this is selected, a “window size” menu becomes available, which allows the window to be defined around a trigger level set with the LEVEL knob.

holdoff

This allows you to disable the oscilloscope's trigger circuit for a definable period of time or number of events *after* a trigger event occurs. The hold-off can be defined as a period of **Time** or a number of **Evts** (events are changes in the input signal that satisfy trigger conditions). The menu knob is used to vary the “holdoff” value. Time values in the range 10 ns to 20 s, or 2 ns to 20 s for the **LC564, LC584, AND LC684 SERIES** may be entered. Event counts in the range 1 to 99 999 999 are allowed.

TRIGGER SETUP: SMART

SETUP
TRIGGER

Press  to access the various SMART Trigger types:

- **Glitch** (see page 8-36)
- **Exclusion** (see page 8-36)
- **Interval** (see page 8-38)
- **TV** (see page 8-39)
- **State- and Edge-Qualified** (see pages 8-40, 8-41)
- **Dropout** (see page 8-42)
- **Pattern** (see page 8-43)
- **Qual First** (see page 8-44)
- **Runt** — *LC564, LC584, AND LC 684 SERIES* (see page 8-45)
- **Slew Rate** — *LC564, LC584, AND LC684 SERIES* (see page 8-46).

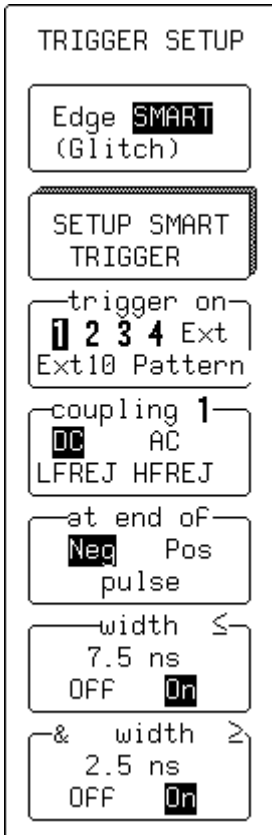

Edge/SMART

Use this to select **SMART**.

SETUP SMART TRIGGER

This primary menu accesses the SMART TRIGGER menu group for choosing the type of SMART Trigger required from the “type” secondary menu. Descriptions of the “type” and other associated SMART menu selections start next page.

Triggers and When to Use Them

SMART TRIGGER — Glitch

```
SMART TRIGGER
  type
  Glitch
  Interval
  TV
  Qualified
  Dropout
  trigger on
  1 2 3 4 Ext
  Ext10 Pattern
  coupling 1
  DC AC
  LFREJ HFREJ
  at end of
  Neg Pos
  pulse
  width ≤
  12.5 ns
  OFF On
  & width ≥
  2.5 ns
  OFF On
```

type

Use this to select **Glitch** (for an explanation of Glitch Trigger, refer to page 8–9).

- **Exclusion Trigger** is also set using these menus — refer to page 8–11.

trigger on

Use this to select the trigger source.

coupling

Use this to select the trigger coupling. HF coupling is not available.

at end of

Use this to define the test on either **Pos**-itive or **Neg**-ative pulses.

width ≤

On instructs the instrument to trigger if the pulse is less than or equal to the value defined here. The value can be adjusted with the associated menu knob, while the test can be turned on or off by pressing the menu button, and used in combination with “width ≥”. You can enter width values in the range 2.5 ns to 20 s (600 ps to 20 s for the **LC564, LC584, AND LC684 SERIES**).

&/OR width ≥

On instructs the instrument to trigger if the pulse is greater than or equal to the value defined here. The value can be set using the associated menu knob. The test can be turned on or off with the menu button, and used in combination with “width ≤”. The two width limits are combined to target glitches within (“&”) a certain range if the “width ≤” value is greater than the “width ≥” value. “OR” indicates that glitches above or below this range will be targeted. Width values in the range 2.5 ns to 20 s (600 ps to 20 s for the **LC564, LC584, AND LC684 SERIES**) can be entered.

SMART TRIGGER — Glitch — Pattern

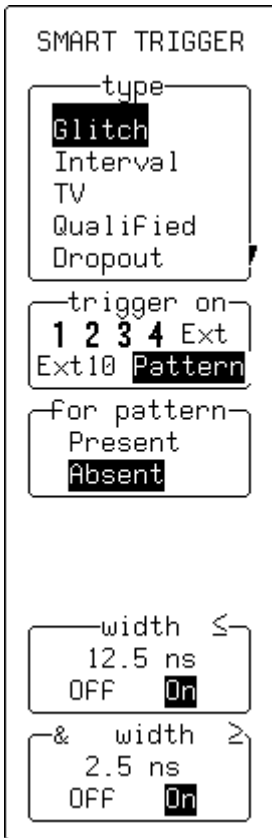

When **Pattern** is selected from “trigger on” in Glitch mode (and also in Interval mode — see next page), the instrument triggers on the logic AND of up to five sources.

type

Use this to select **Glitch** (for an explanation of Glitch Trigger, refer to page 8–9).

trigger on

Use this to select **Pattern**.

for pattern

Use this to select pattern **Present** or **Absent**.

width ≤

Use this to trigger if the pattern is present or absent for less than or equal to the time value defined here. The value can be adjusted with the associated menu knob, and the test commuted to “≥” by pressing the corresponding menu button. You can enter width values in the range 2.5 ns to 20 s (600 ps to 20 s for the **LC564, LC584, AND LC684 SERIES**).

&/OR width ≥

To trigger if the pattern is present or absent for greater than or equal to the time value defined here. The value can be adjusted, and the test commuted to “≤” as per “width ≤”. You can enter width values in the range 2.5 ns to 20 s (600 ps to 20 s for the **LC564, LC584, AND LC684 SERIES**).

Triggers and When to Use Them

SMART TRIGGER — Interval

SMART TRIGGER

type
Glitch
Interval
TV
Qualified
Dropout

trigger on
1 2 3 4 Ext
Ext10 Pattern

coupling 1
DC AC
LFREJ HFREJ

between
Pos Neg
edges

interval \leq
42.5 ns
OFF **On**

OR interval \geq
0.645 ms
OFF **On**

type

Use this to select **Interval** (for an explanation of Interval Trigger, refer to page 8–12).

trigger on

Use this to select the trigger source. When **Pattern** is selected, the instrument triggers on the logic AND of up to five sources, and displays menus as in Glitch-Pattern mode (see previous page).

coupling

Use this to select the trigger coupling. HF coupling is not available.

between

Use this to define the interval between two adjacent **Pos**-itive or **Neg**-ative edges.

interval \leq

Set this to trigger if the interval is less than or equal to the value defined here, which can be adjusted using the associated knob. The test can be turned on or off with the corresponding menu button, and can be used in combination with the “interval \geq ” test. You can enter interval values in the range 10 ns to 20 s (2 ns to 20 s for the **LC564, LC584, AND LC684 SERIES**).

&/OR interval \geq

Set this to trigger if the interval is greater than or equal to the value defined here, which can be adjusted using the associated menu knob. The test can be turned on or off using the corresponding menu button, and can be used in combination with the “interval \leq ” test. The two interval limits are combined to select intervals within (“&”) a range if the “interval \leq ” value is greater than the “interval \geq ” value. “OR” they can be combined to select intervals on either side of this range. You can enter interval values in the range 10 ns to 20 s (2 ns to 20 s for the **LC564, LC584, AND LC684 SERIES**).

SMART TRIGGER — TV

```

SMART TRIGGER
  type
  Glitch
  Interval
  TV
  Qualified
  Dropout
  TV signal on
  1 2 3 4 Ext
  Ext10
  # of Fields
  1 2
  4 8
  TV type
  Standard
  Custom
  as
  625/50/2:1
  525/60/2:1
  trigger on
  Line Field
  315 2
  
```

type

Use this to select **TV** (for an explanation of TV Trigger, refer to page 8-26).

TV signal on

Use this to select the trigger source.

of fields

Use this to define the field number: odd or even.

TV type

Use this to select **Standard** or **Custom** TV decoding.

as

When **Standard** is chosen, this selects “625/50/2:1” (PAL SECAM) or “525/60/2:1” (NTSC) standards.

When **Custom** is selected, this specifies the number of lines and cycles, and setting the interlacing factor for non-standard TV signals.

trigger on

Use this to select the line and field on which to trigger. When it is not important that a line be defined (done using the lower menu knob) “Field” changes to “any” to allow triggering on an unknown line.

Triggers and When to Use Them

SMART TRIGGER — Qualified — State

```
SMART TRIGGER
  type
  Interval
  TV
  Qualified
  Dropout
  Pattern
  by
  Edge State
  (qualifier)
  trigger on
  1 2 3 4 Ext
  Ext10
  only after
  1 2 3 4 Ext
  Ext10 Pattern
  goes & stays
  Above Below
  248mV
  wait
  60 ns
  OFF T< T> Evs
```

type

Use this to select **Qualified** (for an explanation of State-Qualified Trigger, refer to page 8–21).

by

Use this to select **State**.

trigger on

Use this to select the trigger source. Other conditions for this source, such as slope and hold-off, may be set up using Edge Trigger (see page 8–34).

only after

Use this to select the qualifier source. Other conditions for this source, such as slope and hold-off, may be set up using Edge Trigger (see page 8–34). Selecting **Pattern** as the qualifier source offers the choice of pattern “Present” or “Absent” in the menu below.

goes & stays

Use this to select the qualifier threshold by means of the associated knob, and using the menu button to select whether the qualifier signal will be valid **Above** or **Below** that threshold. Selecting **Pattern** as the qualifier source in the menu above offers the choice of pattern “Present” or “Absent.”

wait/within

Use this to specify the time limit (“within” “T<”) for accepting the trigger event. Alternatively, to specify how much time (“wait” “T>”) or how many trigger events (“wait” “Evs”) should be allowed before the acquisition is taken on the next trigger event. The qualifier signal must remain valid until the final trigger has been received. The time value can be chosen in the range 10 ns–20 s (2 ns to 20 s for the **LC564, LC584, AND LC684 SERIES**). The trigger event count can be chosen in the range 1 to 99 999 999.

SMART TRIGGER — Qualified — Edge

```

SMART TRIGGER
  type
  Interval
  TV
  Qualified
  Dropout
  Pattern
  by
  Edge State
  (qualifier)
  trigger on
  1 2 3 4 Ext
  Ext10
  after
  1 2 3 4 Ext
  Ext10 Pattern
  has gone
  Above Below
  -133mV
  within
  130 ns
  OFF T< T> Evs
  
```

type

Use this to select the **Qualified** trigger type (for an explanation of Edge-Qualified Trigger, refer to page 8-23).

by

Use this to select **Edge**.

trigger on

Use this to select the trigger source. Other conditions for this source, such as slope and hold-off, may be set up using Edge Trigger (see page 8-34).

after

Use this to select the qualifier source. Other conditions for this source, such as slope and hold-off, may be set up using Edge Trigger (see page 8-34). Selecting **Pattern** as the qualifier source offers the choice of pattern "Present" or "Absent" in the menu below.

has gone

Use this to adjust the qualifier threshold and determine whether the qualifier signal is valid once it "has gone" above or below that threshold. Selecting **Pattern** as the qualifier source in the menu above offers the choice of pattern "Present" or "Absent."

wait/within

Use this to specify the time limit ("within" "T<") for accepting the trigger event. Or, use it to specify the delay in time ("wait" "T>") or number of trigger events ("wait" "Evs") after a valid transition has occurred. A trigger can only be accepted after this delay. Any subsequent qualifier event restarts this count. The time value can be chosen in the range 10 ns to 20 s (2 ns to 20 s for the **LC564, LC584, AND LC684 SERIES**). The trigger event count can be chosen in the range 1 to 99 999 999.



Triggers and When to Use Them

SMART TRIGGER — Dropout

```
SMART TRIGGER
  type
  TV
  Qualified
  Dropout
  Pattern
  Qual First
  Trigger after
  timeout, if
  NO edge
  occurs on
  1 2 3 4 Ext
  Ext10
  with slope
  Positive
  Negative
  within
  1.64 μs
  (timeout)
  of previous
  edge
```

type

Use this to select **Dropout** (for an explanation of Dropout Trigger, refer to page 8–42).

Trigger after timeout, if NO edge

occurs on

Use this to select the trigger source .

with slope

Use this to define whether the measurement starts on a **Positive** or **Negative** slope of the trigger signal.

within... of previous edge

For defining the time-out value in the range 25 ns to 20 s (2 ns to 20 s for the **LC564, LC584, AND LC684 SERIES**).

SMART TRIGGER — Pattern

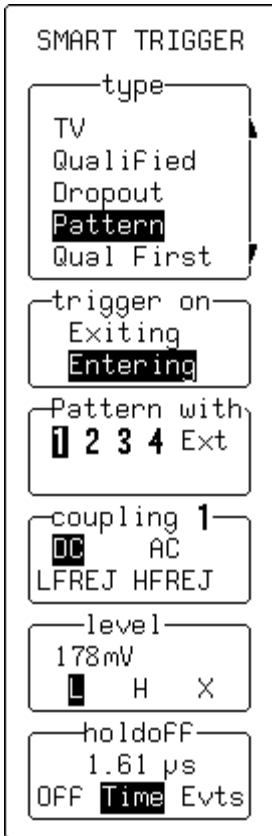

type

Use this to select **Pattern** (for an explanation of Pattern Trigger, refer to page 8–17).

trigger on

Use this to select **Entering** for the instrument to trigger when the pattern starts being *true*, and **Exiting** for triggering when it stops being *true*.

Pattern with

Use this to select the channel to be modified using the lower menus' corresponding menu buttons.

coupling

Use this to select the desired coupling. HF coupling is not available.

level

This is for modifying level values, using the associated knob and the corresponding menu button to choose **L** (low), **H** (high), or **X** (don't care).

holdoff

Use this to disable the trigger circuit for a definable period of time or number of events *after* a trigger event (a change in the input signal that satisfies the trigger conditions). When not turned off, holdoff can be defined as a period of **Time** or a number of **Evts** (events). Use the associated menu knob to vary the "holdoff" value. You can enter time holdoff values in the range 10 ns to 20 s (2 ns to 20 s for the **LC564, LC584A, and LC684**). Event counts in the range 1 to 99 999 are allowed.

Triggers and When to Use Them

SMART TRIGGER — Qualified First

```
SMART TRIGGER
-----type-----
TV
QualiFied
Dropout
Pattern
Qual First
-----by-----
Edge State
(qualiFier)
-----trigger on-----
1 2 3 4 Ext
Ext10
-----aFter-----
1 2 3 4 Ext
Ext10 Pattern
-----has gone-----
Above Below
-64mV
-----wait-----
6 evts
OFF T< T> Evs
```

type

Use this to select **Qual First** (for an explanation of Qualified First Trigger, refer to page 8–24).

by

Use this to select **Edge** or **State**.

trigger on

Use this to select the trigger source. Other conditions for this source, such as slope and hold-off, may be set up using Edge Trigger (see page 8–34).

after

Use this to select the qualifier source. Other conditions for this source, such as slope and hold-off, may be set up using Edge Trigger (see page 8–34). **Pattern** selected as the qualifier source determines whether the pattern should be “Present” or “Absent.”

has gone

To adjust the qualifier threshold and determine whether the qualifier signal is valid once it “has gone” above or below that threshold. Selecting **Pattern** as the qualifier source in the menu above offers the choice of pattern “Present” or “Absent.”

wait/within

To specify the time limit (“wait” “T<”) for accepting the trigger event. Or, to specify the delay in time (“wait” T>) or number of trigger events (“wait” Evs) after a valid transition has occurred. A trigger can only be accepted after this delay. Any subsequent qualifier event restarts this count. You can choose a time value in the range 10 ns to 20 s, and a trigger event count in the range 1 to 99 999 999.

SMART TRIGGER — Runt

LC564, LC584, AND LC684 SERIES ONLY



type

To select **Runt** (for an explanation of Runt Trigger, refer to page 8–30).

trigger on

Use this to select the trigger source.

coupling

Use this to select the trigger coupling. HF coupling is not available.

with

Use this to select and set the three defining conditions for the Runt Trigger:

- When **Level** is selected (not shown at left), these menus appear:

upper level

Use this to set the level of the upper threshold through which the runt must pass.

lower level

Use this to set the level of the lower threshold through which the runt must pass.

- When **Width** is selected, the menus shown at left appear. The two width limits can be combined to select runt pulses within (“&” will appear in the second menu) a certain range if the “runt ≤” value is greater than the “runt ≥” value. Or they can be combined to select runs outside this range (“OR” will appear).

runt ≤

When **On** is selected, there will be a trigger if the runt pulse width is less than or equal to the defined value (600 ps to 20 s), adjusted with the associated menu knob. The test is be turned on or off using the menu button, in combination with “runt ≥”.

&/OR runt ≥

When **On** is selected, there will be a trigger if the runt pulse width is greater than or equal to the defined value (600 ps to 20 s), adjusted with the associated menu knob. This condition can be turned on or off by means of the menu button, and used in combination with “runt ≤”.

- When **Edge** is selected (not shown), the “at end of” menu appears, allowing the trigger to be defined as occurring *at the end of* a “Negative” or a “Positive” runt slope.

Triggers and When to Use Them

SMART TRIGGER — Slew Rate *LC564, LC584, AND LC684 SERIES ONLY*

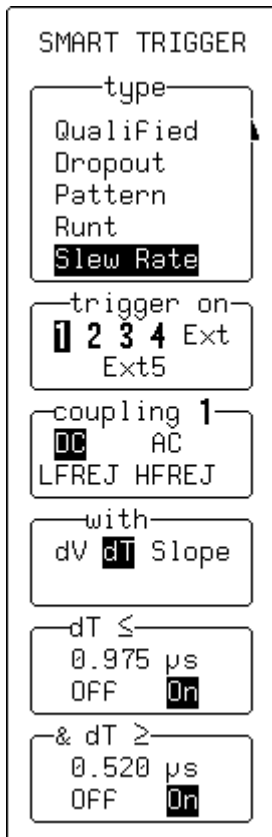

type

Use this to select **Slew Rate** (for an explanation of Slew Rate Trigger, refer to page 8–32).

trigger on

Use this to select the trigger source.

coupling

Use this to select the trigger coupling.

with

Use this to select and set the three defining conditions for the Slew Rate Trigger:

- When **dV** is selected (not shown at left), the following menus appear:

upper level

Use this to select the level of the upper threshold.

lower level

Use this to select the level of the lower threshold.

- When **dT** is selected, these menus appear below:

dT ≤

When **On** is selected, there will be a trigger if the time is less than or equal to the defined value (600 ps to 20 s), adjusted with the associated menu knob. This condition can be turned on or off using the menu button, in combination with “dT ≥.”

&/OR dT ≥

When **On** is selected, there will be a trigger if the time is greater than or equal to the defined value (600 ps to 20 s), adjusted using the associated menu knob. This condition can be turned on or off with the menu button and used in combination with “dT ≤”. They can be combined to select pulses within (“&”) a certain range if the “dT ≤” value is greater than the “dT ≥” value. “OR” they can be combined to select pulses on either side of this range.

- When “**Slope**” is selected (not shown at left), the “with slope” menu appears, allowing the slope to be defined as “Negative” or “Positive.”

#

ZOOM + MATH Controls

A wide range of Zoom and Mathematical processing functions (detailed in the next chapter) can be performed on acquired waveforms with the controls described here.

Four processed traces are available for normal zooming or for waveform mathematics. Any one of traces A, B, C or D can be set up to zoom another of these, or another trace acquired on any channel or stored in one of the four reference memories M1–M4. Trace A, for example, could be set up to zoom Trace B, C, or D, but not itself. The Displayed Trace label at the left of the screen indicates the source.

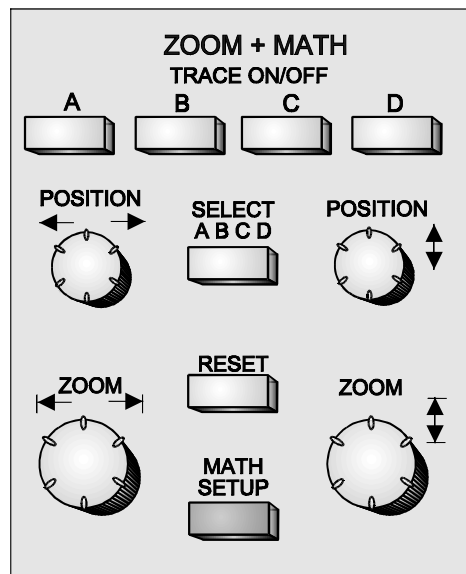

The **A TRACE**

ON/OFF buttons display the corresponding trace A, B, C, or D. When a trace is switched on, the **POSITION** and **ZOOM** knobs and the **RESET** button (described next page) will then be attributed to this, the *active* trace.

The **SELECT ABCD** button assigns the controls to the active trace for adjustment because only one trace can be modified at a time. Pressing this button activates the next trace in the A to D sequence.

The four **ZOOM + MATH** knobs adjust the horizontal and vertical positions and expansion factors of the zoomed trace...

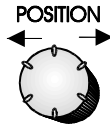

The **POSITION** knob repositions zoomed traces *horizontally*. If the source of the expanded waveform is displayed, an intensified region corresponding to the area of expansion is shown.

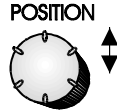

Whereas the knob *vertically* repositions the active trace.

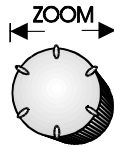

The knob *horizontally* expands or contracts the active trace. If the source of the zoomed trace is also displayed, it will show an intensified region corresponding to the area of expansion.

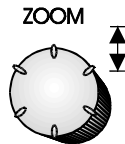

While the knob *vertically* expands or contracts the active trace.



The **RESET** button resets the vertical and horizontal **POSITION** and **ZOOM**.



Finally, the **MATH SETUP** menu-entry button accesses the zoom, math, and sequence segment features. See next chapter for details.

#

Zooming for Precise Waveform Measurement

You can zoom several traces from a single waveform to obtain precise timing measurements.

For instance, on a waveform composed of two pulses separated by a long delay, Trace A could be made a zoom of the first pulse, and Trace B a zoom of the second.

The combination of long memory and zoom capability allows extremely accurate measurements of time intervals. Thus the time resolution on the viewed trace can be significantly improved.

For example, choosing 50 000 points per channel on a timebase of 0.1 ms/div, traces can be expanded to as much as 50 ns/div — a factor of 2000. Using Relative Time cursors (see Chapter 14), this means that a delay of 500 μ s could be measured with a resolution as high as 0.5 ns. Even with as many as eight million points acquired, successive zooming can be done until there are only a few points on the screen.

Using Multi-Zoom

With Multi-Zoom, the zoomed region of the waveform can be moved simultaneously along two or more different traces, or two or more regions of the same trace.

When Multi-Zoom **On** is selected from the ZOOM – MATH menu (see page 10–8), the horizontal zoom and position controls apply simultaneously to all displayed traces — A, B, C, and D — allowing similar sections of different traces to be viewed at the same time. However, the vertical controls still act on the traces individually (see previous chapter). The highlighting of trace titles in the Displayed Trace label indicates an active Multi-Zoom.

Zooming Math Functions

When Trace A, B, C, or D is defined as a mathematical function rather than as a simple zoom (see next section), the zoom controls remain operative; that is, it is not necessary to define another trace as a zoom of the math function. In order to view the entire mathematical function, simply cancel any expansion or position change by pressing RESET.



Math Functions and Options

Descriptions of the Setup menu's zoom, math, and waveform processing functions start on page 10–6. Averaging and Extrema are outlined on this and following pages.

For details on Enhanced Resolution filtering see Appendix B.

How to set up FFT (Fast Fourier Transform) is explained at the conclusion of this chapter. FFT theory and practice are described in Appendix C.

A wide range of standard or optional mathematical and waveform processing functions is available on LC Series oscilloscopes. Not all functions are described here. Those such as Histogram, Trend, and Correlate are described in their dedicated Operator's Manuals, if these functions are installed in the oscilloscope.

The scope's standard waveform mathematics functions consist of waveform negation, identity, addition, subtraction, multiplication and division, summed averaging of up to 1000 waveforms and the $(\sin x)/x$ interpolation function.

The advanced waveform processing features include the following:

- Continuous Averaging (menus on page 10–10)
- Summed Averaging of up to 1 000 000 waveforms (menus on 10–10)
- Enhanced Resolution by up to 3 bits with filtering (menus on page 10–11)
- Extrema — envelope of many waveforms (menus on page 10–12)
- Fast Fourier Transform, including FFT averaging (menus on pages 10–13 and 10–14)
- Mathematical Functions such as Integral, Derivative, Logarithm, Exponential, Square, and Square Root (menus on page 10–15)

Continuous Averaging

This is the repeated addition (with *unequal* weight) of successive source waveforms. It is particularly useful for reducing noise on signals that drift very slowly in time or amplitude.

However, the statistics of a continuous average tend to be worse than those from a summed average (see next page) on the same number of sweeps. This is because the most recently acquired waveform has more weight than all previously acquired ones: the continuous average is dominated by the statistical fluctuations of the most recently acquired.

The weight of 'old' waveforms in the continuous average tends to zero (following an exponential rule) at a rate that decreases as the weight increases.

Summed Averaging

Summed Averaging is the repeated addition (with *equal* weight) of successive source waveform records. If a stable trigger is available, the resulting average has a random noise component lower than that of a single-shot record.

When the maximum number of sweeps is reached, the averaging process stops. An even larger number can be accumulated simply by changing the number in the SETUP "for" menu. However, the other parameters must be left unchanged or else a new averaging calculation will be started.

You may interrupt the process by changing the trigger mode from NORM to STOP or by turning off the active trace, using the respective buttons. Averaging will be resumed when you do the opposite. The accumulated average is reset when you push the CLEAR SWEEPS button or change an acquisition parameter such as input gain, offset, coupling, trigger condition, timebase, or bandwidth limit. The number of current averaged waveforms of the function or its expansion is shown in the Displayed Trace label.

When you select summed averaging, the display is updated at a reduced rate — about once every 1.5 s — in order to increase the averaging speed (points and events per second).

Summed averaging can also be done on sequence waveforms to give the average of the segments. It can also be applied to an expansion of a sequence segment, giving the segment's average waveform over many sequence acquisitions.

Extrema Waveforms

These are computed by a repeated comparison of successive source waveform records with the already-accumulated extrema waveform, which consists of a maxima (roof) and a minima (floor) record. Whenever a given data point of the new waveform is greater than the corresponding maximum roof-record value, or less than the corresponding floor value, the new data point replaces the old. Thus the maximum and the minimum envelope of all waveform records is accumulated.

Roof and Floor records can be displayed individually or together.



Zoom, Mathematics, and Math Setup

When the selected maximum number of sweeps is reached, the accumulation stops. You can interrupt the same process by changing the trigger mode from Normal to Stopped or by turning off the function trace. Accumulation will continue if you do the opposite.

You can reset the currently accumulated extrema waveform by pushing the CLEAR SWEEPS button or by changing an acquisition parameter, such as input gain, offset, coupling, trigger condition, or the timebase or bandwidth limit. The number of currently accumulated waveforms is displayed in the function's Displayed Trace Label or that of its zoom expansion.

When the maximum number of sweeps is reached, an even larger number can be accumulated simply by changing the number in the SETUP "for" menu. However, the other parameters must be left unchanged or else the extrema calculation will be restarted.

Using Waveform Mathematics

You can apply waveform mathematics to any channel or reference memory. Furthermore, any trace of A, B, C, or D can be set up as a math function, allowing several computations to be made in sequence.

For example: Trace A could be set up as the difference between Channels 1 and 2, Trace B as the average of A, and Trace C the integral of B. Thus the integral of the averaged difference between Channels 1 and 2 is displayed.

In order to avoid slowing down the instrument with unwanted computations, a particular mathematical function is only computed when its display is turned on. Using the same example as above, however, it would be sufficient to display Trace C alone because the instrument knows it must compute A and B before C.

Waveform processing can also take time when many data points are involved. This delay can be cut by limiting the number of data points used in the computation. To do this, the instrument will process the entire waveform by taking every N^{th} point, where N depends on the timebase and the desired maximum number of points. The first point taken is always the data value at the left-hand edge of the screen.

Combining Channels

Zoom and math functions on Traces A, B, C, D, and Reference Memories M1, M2, M3, and M4 use the instrument's system memory, which is dynamically allocated to each trace as required. When you achieve more acquisition memory by combining channels, a single long trace can consume all the reference memory or zoom and math trace capacity in the instrument. When this happens, an on-screen message will warn you of the possibility of accidentally storing a new trace to a reference memory already in use. Refer to Chapter 7.

Note: A processing title for each displayed trace will be shown in the Displayed Trace Label. If the title is missing, the desired processing cannot be done, and the contents of the trace remain unchanged.



Configuring for Zoom and Math

MATH
SETUP

Press  to configure any of the four traces and to execute any zoom or math function using the “ZOOM + MATH” menus.

Any trace and function can be chained to another trace and function (not all functions shown may be available on your oscilloscope). Trace A, for example, could be made an average of CH 1, Trace B an FFT of A, and Trace C a zoom of B. All traces can be viewed simultaneously by means of the TRACE ON/OFF buttons; and any function can be zoomed directly.

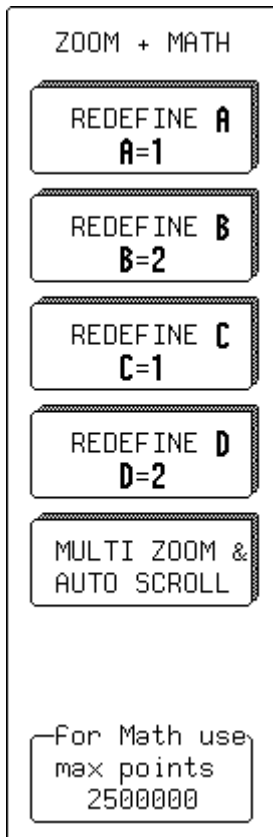

REDEFINE A, B, C, or D

Select one of these to redefine a trace and to access the SETUP menus (described in the remainder of this chapter, using Trace A as an example).

MULTI ZOOM & AUTO SCROLL

This selection accesses the Multi-Zoom and Auto Scroll functions (see page 10–8). With Multi-Zoom activated, all displayed zoom traces are simultaneously controlled by the horizontal POSITION and ZOOM knobs, and by Auto Scroll. When Multi-Zoom is not used, only the active zoom trace is controlled. Auto Scroll displays the captured signal with a zoom expansion that automatically moves across the screen. You can select the scroll speed, scroll through the acquired waveform and pause on any feature.

Selected (not shown)

When a trace with a zoom of a sequence-mode waveform is selected, the “Selected” menu becomes accessible. Press the corresponding menu button to toggle the selection between display of a single, specific “Segment” and “All Segments.” With “Segment” selected, the associated knob can be used to choose specific segments.

for Math use max points...

This is for selecting the maximum number of points for all math operations. A low number increases computation speed.

SETUP OF ...

This appears when "REDEFINE A" (for example) is selected from the "ZOOM + MATH" menus.

SETUP OF A

use Math?
 No Yes

Trace A is
ZOOM of

1 2 3 4 B C D
M1 M2 M3 M4

use Math?

This is for toggling between **No** (Zoom only) and **Yes** (Math functions) setups.

Trace A, B, C, or D is ZOOM of

This selects the source trace to be zoomed.



Zoom, Mathematics, and Math Setup

AUTO SCROLL

This appears when “ZOOM and Auto-Scroll” is selected from the ZOOM + MATH menu group. MULTI-ZOOM unifies the control of all zoom traces, while AUTO-SCROLL moves the zoom trace (or traces) across the referenced trace.

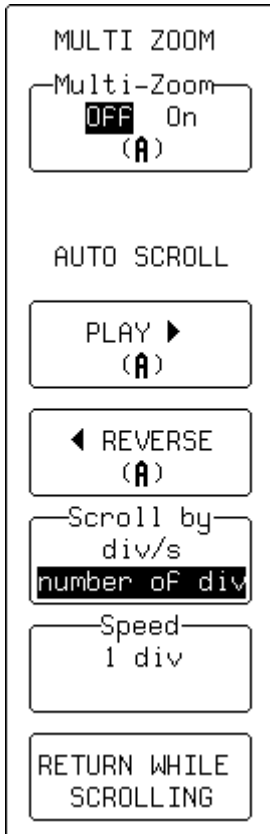

MultiZoom

When **Off** is selected, only the active zoom trace is controlled. When **On** is selected, all displayed zoom traces (A,B,C,D) are automatically controlled at the same time with Auto Scroll, and manually with the horizontal ZOOM and POSITION knobs.

PLAY ►

Use this feature to scroll the zoom trace from right to left. When active, the label displays “STOP (PLAYING): Press to stop.”

◀ REVERSE

Use this feature to scroll the zoom trace from left to right. When active, the label displays “STOP (REVERSING)”: Press to stop.

Scroll by

Use this feature to scroll by divisions per second or by number of divisions. Use **div/s** to scroll continuously. Use **number of div** for waveform processing, especially Pass/Fail testing. When processing is completed, the display will be updated by the number-of-divisions set.

Speed

Use this knob to set scroll speed. When you are scrolling by divisions, **10 div** will step the zoom trace “grid page” by “grid page” across the length of the referenced trace.

RETURN WHILE SCROLLING

While continuing to scroll, use this button to return to the previous menus.

Note: If you press the standard RETURN button, the waveform will stop scrolling and the previous menu will be displayed.

Arithmetic

— allows addition, subtraction, multiplication and division, as well as choice of the two operands and the operator. The example on this page shows a setup of trace A as the sum of Channels 1 and 2.

```

SETUP OF A
  use Math?
  No Yes
  Math Type
  Arithmetic
  Average
  Correlate
  Enh.Res
  Extrema
  Sum
  Difference
  Product
  Ratio
  1 2 3 4 B C D
  M1 M2 M3 M4
  plus
  1 2 3 4 B C D
  M1 M2 M3 M4
  
```

use Math?

Select **Yes** to enable the choice of a math function.

Math Type

Use this submenu to select **Arithmetic**.

- Sum**
- Difference**
- Product**
- Ratio**

Use this submenu to select the operator.

- 1 2 3 4 B C D**
- M1 M2 M3 M4**

Use this submenu to select one of two operand source traces.

- plus 1 2 3 4 B C D**
- M1 M2 M3 M4**

Use this submenu to select the other operand source trace.

Zoom, Mathematics, and Math Setup

Average

SETUP OF A

use Math?
No **Yes**

Math Type
Arithmetic
Average
Correlate
Enh. Res
Extrema

Avg Type
Summed
Continuous

for
1000
(sweeps)

of
1 2 3 4 B C D
M1 M2 M3 M4

This feature offers Summed (Linear) or Continuous (Exponential) Averaging. Shown here is an example setup of trace A as a Summed Average (over 1000 sweeps) of Channel 1. (See also page 10-2.)

use Math?

Select **Yes** to enable the choice of a math function.

Math Type

Use this submenu to select a specific math function (**Average** in this case).

Avg Type

Use this to select **Summed** or **Continuous** averaging method.

for / with

When you select **Summed** averaging, “for...sweeps” lets you specify the number of sweeps. If you select **Continuous** averaging, however, the same menu item becomes “with...weighting,” which lets you define the weight. The difference between the two choices is that when **Summed** is selected the *first* n sweeps will be taken into account, whereas in **Continuous** averaging the *last* sweep will be given a weight of 1 and the previous result a weight of n in the calculations.

of

Use this to select the source trace for averaging.

Enhanced Resolution

This lets you select low-pass digital filters that increase the resolution of the displayed signal at the expense of its bandwidth. (See Appendix B for a detailed explanation.)

These digital filters work very much like analog bandwidth-limit filters. In Single-Shot mode, they and the sampling speed affect bandwidth. If high bandwidth is needed at slow timebases, you should consider averaging and repetitive sampling instead.

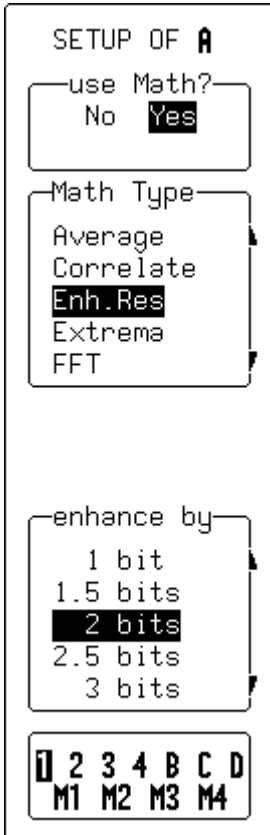

use Math?

Select **Yes** to enable the choice of a math function.

Math Type

Use this submenu to select **Enhanced Resolution**.

enhance by

Use this submenu to select the filter that will enhance resolution of the displayed signal. Enhancement is possible from one to three bits in 0.5-bit steps.

1 2 3 4 B C D M1 M2 M3 M4

Use this to select the source trace for filtering.

Zoom, Mathematics, and Math Setup

Extrema

This is used for acquiring a trace envelope over many acquisitions (see also page 10–3).

SETUP OF A

use Math?
No Yes

Math Type
Correlate
Enh.Res
Extrema
FFT
FFTAVG

limits
Env
Floor Roof

for
1000
(sweeps)

of
1 2 3 4 B C D
M1 M2 M3 M4

use Math?

Select **Yes** to enable the choice of a math function.

Math Type

Use this submenu to select **Extrema**.

limits

Use this submenu to select either **Envelope**, **Floor**, or **Roof**. Floor shows only the lower, and Roof only the upper part of the envelope. Changing the limits does not force the analysis to start again.

for

This lets you select the number of sweeps.

of

This lets you select the source trace.

FFT

This is used to display the Fast Fourier Transform (FFT) of a signal and to view it in the frequency domain. (See the final section of this chapter, and Appendix C, for when and how to use FFT.)

```

SETUP OF A
-----
use Math?
  No  Yes
-----
Math Type
  Enh. Res
  Extrema
  FFT
  FFTAVG
  Functions
-----
FFT result
  Phase
  Power Dens
  Power Spect
  Real
  Real+Imag
-----
with window
  Hamming
  DC  AC
-----
of
  1 2 3 4 B C D
  M1 M2 M3 M4
  
```

use Math?

Select **Yes** to enable the choice of a math function.

Math Type

Use this submenu to select **FFT**.

FFT result

Use this submenu to select the FFT's output format: **Imaginary**, **Magnitude**, **Phase**, **Power Dens-ity**, **Power Spect-rum**, **Real** or **Real + Imag**.

with window

Use the corresponding menu button to select the FFT window type, and the associated knob to select **AC** or **DC**.

of

Use this to select the source trace.

Notes

- *During Fast Fourier Transform computation the FFT sign is displayed in the lower right-hand corner of the screen.*
- *The computation of FFT on long time-domain records can take a while.*
- *You can interrupt or cancel the computation at any time by using any front-panel control.*



Zoom, Mathematics, and Math Setup

FFT Average

This is used for displaying the FFT power averaging of an FFT source trace. Power averaging is useful for characterizing broadband noise or periodic signals without a stable trigger signal. Total power — signal and noise — is measured at each frequency. The source trace must be an FFT function. (See the final section of this chapter, and Appendix C, for when and how to use FFT.)

SETUP OF A

use Math?
No Yes

Math Type
Extrema
FFT
FFTAVG
Functions
Histogram

FFT result
Magnitude
Power Dens
Power Spect

for
1000
(sweeps)

of
B C D

use Math?

Select **Yes** to enable the choice of a math function.

Math Type

Use this submenu to select **FFT AVG**.

FFT result

Use this submenu to select the output format of the FFT Average: **Magnitude**, **Power Density**, or **Power Spectrum**.

for

Use this to select the number of sweeps.

of

Use this to select the FFT source.

Note: FFT Average can be reset by pressing **CLEAR SWEEPS**. The number of currently accumulated waveforms is then shown in the *Displayed Trace* field of the function or its expansion.

Functions

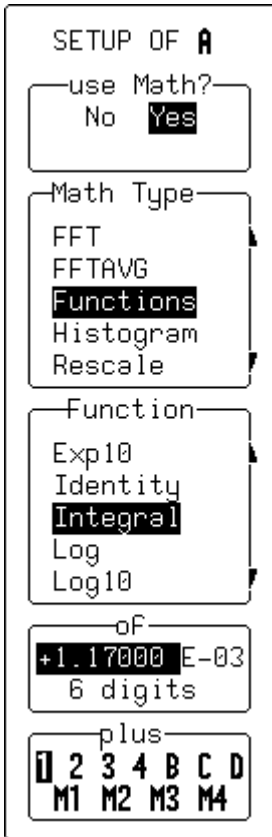

This gives you access to a variety of Math display functions.

use Math?

Select **Yes** to enable the choice of a math function.

Math Type

Use this submenu to select **Functions**.

Function

Use this submenu to select a function type from:

- Absolute value
- Derivative
- Exp (base e)
- Exp 10 (base 10)
- Identity
- Integral
- Log (base e)
- Log 10 (base 10)
- Negation
- Reciprocal
- Sinx/x
- Square
- Square root

of

This is used to select the signal offset (used to compensate for any DC offset in the signal).

plus

Use this submenu to select the source trace.

Notes for Math Functions

- *Square root is computed on the absolute value of the source waveform.*
- *For logarithmic and exponential functions, the numerical value (without units) of the input waveform is used.*
- *For the integral function, the source waveform may be offset by an Additive Constant in the range -10^{16} to $+10^{16}$ times the vertical unit of the source waveform.*



Zoom, Mathematics, and Math Setup

Resample

SETUP OF A

use Math?
No Yes

Math Type

Functions
Histogram
Resample
Rescale
Trend

Delay By
20.67 ns

1 2 3 4 B C D
M1 M2 M3 M4

This deskew feature allows a signal on one channel to be resampled, and adjusted in time relative to a signal on another channel. It is valuable wherever there is the need to compensate for different lengths of cables, probes or other factors causing timing mismatches.

use Math?

Select **Yes** to enable the choice of a math function.

Math Type

Use this submenu to select **Resample**.

Delay By

Use this to set the adjustment (deskew) that will compensate for the timing differences between signals on two channels, using the associated menu knob (range = ± 2000 ns).

1 2 3 4 B C D M1 M2 M3 M4

Use this submenu to select the source trace.

Rescale

This is used for selecting a waveform and adjusting a (the multiplication factor) and b (the additive constant) in the formula:

$$(a * \text{waveform}) + b,$$

where both constants can have values ranging between -10^{15} and $+10^{15}$.



use Math?

Select **Yes** to enable the choice of a math function.

Math Type

Use this submenu to select **Rescale**.

(a * 1) + b

Use this to select **a** or **b**.

a = / b =

The corresponding menu button for this menu highlights the mantissa, the exponent, or the number of digits, while the associated knob changes the highlighted value.

1 2 3 4 B C D
M1 M2 M3 M4

Use this submenu to select the source trace.



Setting Up FFT Span and Resolution

The FFT (Fast Fourier Transform) converts a time domain waveform into frequency domain spectra similar to those of an RF spectrum analyzer display. But unlike the analyzer, which has controls for span and resolution bandwidth, FFT span is determined by sampling rate, while resolution bandwidth is inversely proportional to record length.

Frequency Resolution Δf Correctly setting up an FFT starts with the frequency resolution (Δf). This parameter is the spacing of samples in the frequency domain display. The Δf is set by inputting the time duration of the time domain signal to the FFT. If an acquisition channel (Channel 1, 2, 3, or 4) is the source, the waveform duration is the capture time: the TIME/DIV setting multiplied by ten. The relationship between capture time and frequency resolution is illustrated here.

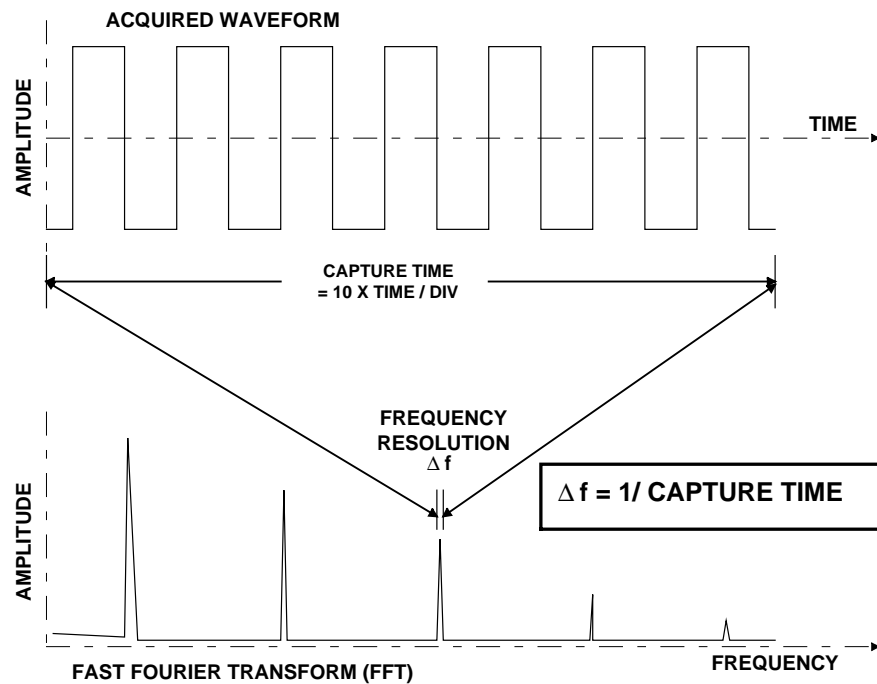

Setting the Span

Similarly, if the source waveform is a zoom trace, the frequency resolution is the reciprocal of the displayed waveform's duration.

The frequency span of the FFT is called the Nyquist frequency and is related to the sampling frequency of the time domain waveform. If the math memory size, which is set using the "for Math use max points" menu (see page 10-6), is identical to the number of samples in the acquired waveform (Chapter 7, TIMEBASE menus), the span will be half the sampling frequency. But if this "max points for math" number is less than the number of points, the waveform and, in turn, the FFT span will be decimated. The relationship between the span of the FFT and the sampling rate ($1/\Delta T$) is illustrated here.

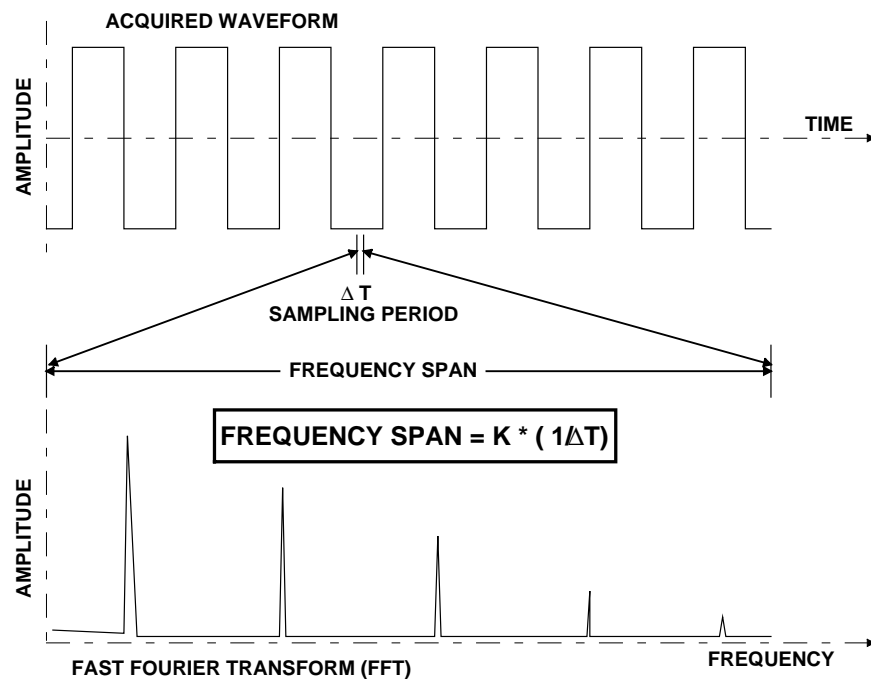



Zoom, Mathematics, and Math Setup

The constant K in the illustration includes the decimation factor described above, as well as automatic display scaling factors. This scaling is required to ensure that the FFT's horizontal display scale falls into a 1, 2, or 5 factor.

In essence, the oscilloscope automatically adjusts the span (and hence the FFT transform size) to account for the user-entered "max points for math" and the display scaling. In some combinations of these factors it also adjusts the length of the displayed trace.

You can determine the span from the Displayed Trace Label for the math trace containing the FFT. This will show the horizontal calibration in Hz/div. The span is also explicitly shown as the Nyquist frequency in the information field that appears at the bottom of the screen when the "MATH SETUP" menus are displayed, as shown here.

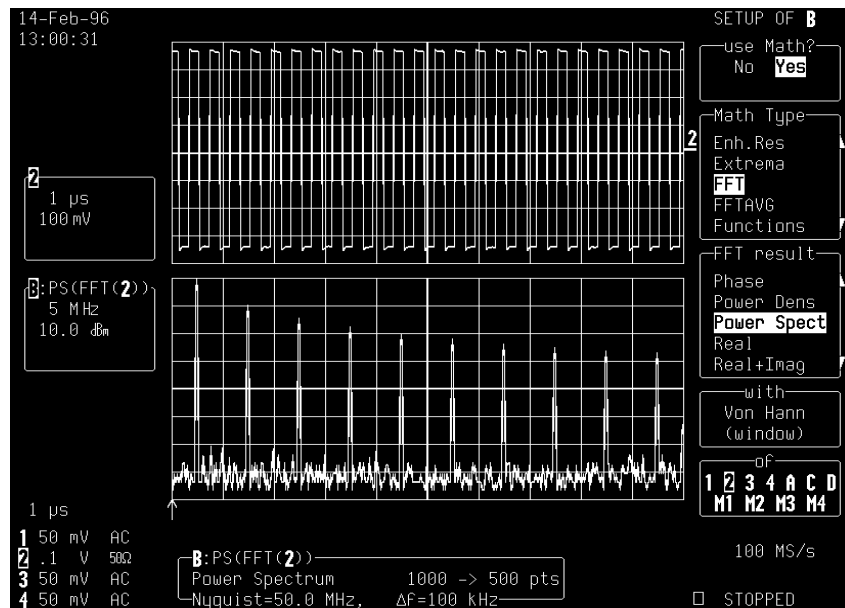

Essentially...

To achieve a desired FFT span, first make sure that the sampling rate is more than twice the span desired. Control the sampling rate using the TIME/DIV knob and set the acquisition memory length with the "TIMEBASE" menu. The sampling rate can be further adjusted by limiting the number of points in the "for Math use max points" menu.

Example

Set up the oscilloscope for an FFT with a span of 10 MHz and a frequency resolution of 10 kHz, to analyze a continuous, periodic waveform.

1. The required frequency resolution demands a waveform duration (capture time) of 100 μ s. Set the TIME/DIV to 10 μ s to achieve the necessary Δf of 10 kHz.
2. To obtain the specified 10 MHz span, the effective sampling rate must be >20 MS/s. On an oscilloscope with a sampling rate of 500 MS/s, for example, the default memory length of 50 000 samples and a TIME/DIV setting of 10 μ s would be used to first give a span of 250 MHz. Now, to obtain a span of 10 MHz, the sampling rate must be reduced. This can be done in two ways:
 - a) In "TIMEBASE": decrease the number of samples by setting the "RECORD UP TO" menu to 2500 results in a sampling rate of 25 MS/s.
 - b) With "ZOOM + MATH": set the "for Math use max points" menu to 2500. This would leave the sampling rate at 500 MS/s but decimate the waveform data before the FFT to reduce the effective sampling rate to 25 MS/s. This would in turn result in a span of 12.5 MHz, the closest achievable span to >10 MHz.

Note: The technique described in b) above is preferred because it maintains a high input sampling rate and reduces the risk of aliasing the acquired data.



Zoom, Mathematics, and Math Setup

The example illustrated below shows how the oscilloscope maintains the display factor. A sampling rate of 25 MS/s would result in a full scale range of 12.5 MHz or 1.25 MHz/div. To maintain a display scale factor of 1, 2, or 5, it decimates the acquired waveform and calculates the FFT using a 2000-point transform. This results in a scale factor of 2 MHz/div. The display is truncated at 6.25 divisions to retain the original span of 12.5 MHz.

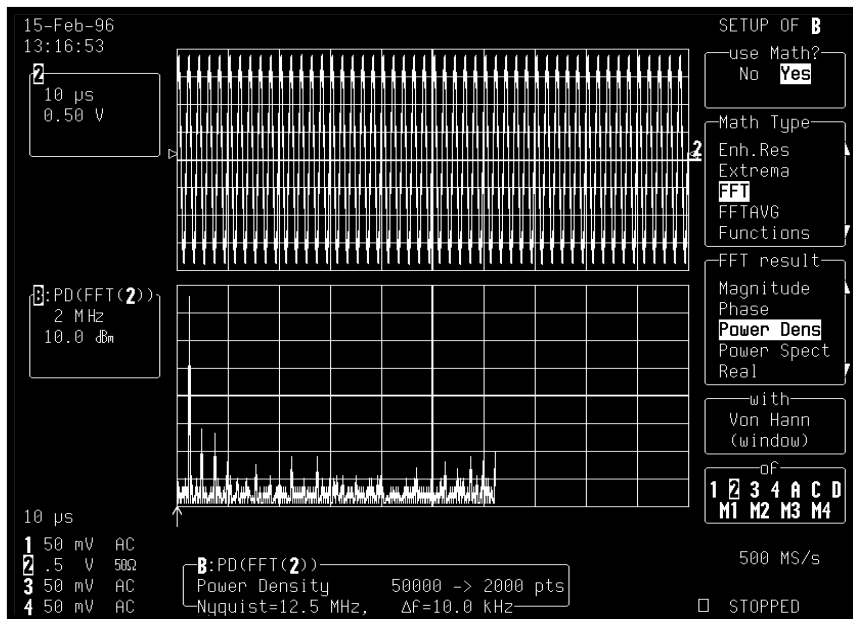

#

Revealing the Complete Picture

The large display reveals the complete picture with advanced color management. Colors are used to give on-screen objects added depth and distinctness, and to clarify their relationships.

The display is intelligent as well as powerful. Color and intensity are managed automatically in real time by a hardware-supported system that has the added advantage of very low software-overhead. Traces can be displayed opaquely or transparently. Overlapping objects — traces over traces or traces over grids — are always visible in transparent mode (see page 11–3).

Signals and their related data are color associated (page 11–2). Each trace has its own dedicated color and persistence data maps. Backed by 1 MB of video memory, infinite and variable persistence displays are automatically color matched to the parent trace. Related traces and text, screen icons, and parent–daughter zoom regions are also linked by color. As many as eight traces can be displayed at once, on eight separate grids (page 11–12). The Full Screen function uses the entire screen area to display traces (page 11–10).

There are six preset color schemes and four personal color palettes you can customize (page 11–20), drawing on more than 40 different colors (page 11–3).

The unique Analog Persistence™ feature (see page 11–5) offers advantages of an analog display in a digital oscilloscope. Use of the brightness level of a single color to denote relative signal intensities is the standard Persistence mode. Also available is Color Graded Persistence (page 11–15), which uses a color spectrum from red through violet to map signal intensity. Both persistence modes are infinite or variable with decay over time. They can be chosen from the DISPLAY SETUP menu (see descriptions starting page 11–7).



How On-Screen Objects are Displayed

The Advanced Color Management System ensures that both the objects and the relationships between them are always clearly visible — even when the objects overlap. Objects include:

- **Waveforms, including envelopes and intensified regions**
- **Grids**
- **Parameter Measurements**
- **Cursors**
- **Status Information**

Background Color

Color management of the background plays an important role in bringing out the links and differences between displayed objects. The choice of background colors has been purposely limited to the darker colors so that displayed objects are more clearly defined and recognizable. The colors of objects that are too close in hue to the chosen background color are automatically changed so that these objects always stand out from the background.

Trace Color Association

The base color of a trace is specified for each color scheme. However, the expanded or zoomed sections of a trace can be given their own colors, so that a single trace may have a number of colors at once: its principal color plus those of the expansions.

Text Color Association

Trace-related text includes pieces of on-screen information that describe measurement parameters, cursors, triggers, waveforms, and channels. A standard text color for all on-screen text exists in the preset color schemes, or can be chosen for custom palettes. Waveform source descriptions including parameter string, acquisition setup, status screen, and trigger information will be in the trace color, even when contained in a text string (the remainder of which will be in the text color). Waveform descriptor boxes — trace labels — and the information they contain always take the color of their respective trace.

Other Color Links

Most menus are displayed in the text color only. The active trigger edge or trigger condition shows source-related information in the trace color, as does the trigger icon. But the titles of Channel

Coupling menus are trace-colored, and Math Setup menu sources have their own color as well.

Overlap Management

Selection of the **Opaque** presentation of overlapping waveforms places one on top of another in normal, non-transparent layers. You can also select the order in which traces appear (see below).

However, when **Transparent** is chosen and overlap mixing is used, those areas of the waveforms that overlap will automatically change color while grid intensity remains constant. But this contrast enhancement marks the overlapping regions so that they stand out. Overlap managed traces always remain distinct in relation to other displayed objects and to the background.

Display Order

This is another mechanism for recognizing displayed objects, which automatically overlays them on the screen in sequence.

When dealing with traces of the same type, the foremost trace is described in the top-left trace label, the next in the second trace label, and so on in descending order towards the background and the bottom of the screen, respectively. You can change this order with the CHANNELS TRACE ON/OFF buttons.

When different types of traces are displayed, by default they are placed in ascending order from the grid at the bottom as follows: envelope traces, persistence traces, normal traces, and cursors. This sequence can also be customized.

For extrema waveforms the sequence is followed by a repeated scanning of normal traces, ensuring that they are always viewed within extrema, regardless of display order. Thus each trace is visible within its envelope, persistence, or Pass/Fail mask; grid lines never hide trace features; and cursors are always visible.

Neutral Highlighting

Any color can be chosen as “neutral” in the four user color schemes; a neutral color is designated by default in each of the six preset schemes. When the “Measure Gate” function is switched on, this designated neutral color automatically relegates display objects of limited interest to the area *outside* the measurement-gate region (see page 11–21), thus indirectly highlighting the area of greatest interest *inside* the gated region.

Pass/Fail Testing

When overlap mixing is used for Pass/Fail mask testing, together with a well-selected color scheme (for example, default scheme “1”) and the measurement-gate highlighting described above, the trace area outside the mask is placed in clear relief.



THE COLORS			
White	Dark Cyan	Ocean Spray	Fuchsia
Cyan	Cream	Ice Blue	Raspberry
Yellow	Sand	Pastel Blue	Neon Pink
Green	Amber	Pale Blue	Pale Pink
Magenta	Olive	Sky Blue	Pink
Blue	Light Green	Royal Blue	Vermilion
Red	Jade	Deep Blue	Orange
Light Gray	Lime Green	Navy	Cerise
Gray	Apple Green	Plum	Khaki
Slate Gray	Emerald Green	Purple	Brown
Charcoal Gray	Grass Green	Amethyst	Black

Analog Persistence

Analog Persistence provides an analog view of signals while maintaining digital data manipulation flexibility.

ANALOG
PERSIST

Press  or use the DISPLAY SETUP “Persistence” menu (see page 11–14) to activate the oscilloscope’s persistence functions.

Why Analog Persistence?

With traditional analog instruments, data manipulation and the direct comparison of acquisitions is practically impossible. Statistical analysis is also difficult to perform. Nevertheless, analog does have certain advantages. Because there is no analog-to-digital conversion, the speed of the analog scope is limited only by the bandwidth of its electronics: signals are monitored almost continuously. The standard DSO (Digital Storage Oscilloscope) must capture signals across the time period allowed by the size of its acquisition memory, then process and display their representation. The time needed to process the previous acquisition limits DSO speed.

LeCroy’s unique Analog Persistence offers the advantages of analog display in a DSO. The display looks like an analog display and is fast. But it provides the data manipulation, flexibility, and statistical analysis only found in a digital instrument.

How it Works

DSOs with Analog Persistence are fast because data accumulation is decoupled from display. New data is accumulated and displayed more quickly. Moreover, the persistence is variable. The display is generated by repeatedly sampling amplitudes of events over time and accumulating the sampled data into three-dimensional display maps. These maps create an analog-style display. User definable persistence duration can be used to see how the maps evolve proportionally over time. Statistical integrity is preserved because the duration, or decay, is proportional to the persistence population for each amplitude or time combination in the data.



In addition, Analog Persistence provides user-definable, post-acquisition saturation control of the maps, allowing detail to be easily drawn out of the display.

Shades of Persistence

When Analog Persistence is selected, each channel and its associated persistence data map are assigned a single color (whereas the related Color Graded persistence function renders the maps in different colors in the red-to-violet spectrum). As a persistence data map is rendered to the screen, different shades of its color are assigned to the population ranges between a minimum and a maximum population. The maximum population automatically receives the brightest shade, the zero or smallest population the darkest shade or the background color, and the population ranges between zero and the maximum population the shades in between.

The information in the lower populations, or down at the noise level (random transients rather than dominant signals) can often be of greater interest than the rest. The distribution of data here is highlighted by shades and color so that it can be examined in detail.

You can select a saturation level or population specified as a percentage of the maximum population. All populations above the saturation population are then assigned the brightest shade; that is, saturated. At the same time, all populations below the saturation level are assigned the remaining shades from brightest to darkest.

Data populations and their displayed shades are dynamically updated as data from new acquisitions is accumulated.

Setting Up the Display

Press  to access the DISPLAY SETUP menus (see page 11–13) and to select from

- “Standard” or “XY” mode and grids
- Persistence
- Dot Join
- “Single” (1), “Dual” (2), “Quad” (4), or “Octal” (8) grids
- Display and grid intensities
- “More Display Setup” menus

Standard or XY Display

Standard display (menus on page 11–13) allows presentation of source waveforms versus time (or versus frequency for FFTs).

XY display (menus on page 11–16) compares and contrasts one source waveform with another, and is used when selected traces have the same time or frequency span (time/div) and horizontal unit (in seconds or Hertz). XY is automatically generated as soon as you select two compatible traces. If you select incompatible traces, a warning message is displayed at the top of the screen. And if compatible traces are not matched in time, their XY diagram will be displayed showing the shift in time or frequency between them. (The ΔT or Δf indicator is displayed in the Displayed Trace Label to the left of the screen.)

Persistence

In Persistence Mode, the oscilloscope can display points so that they accumulate on-screen over many acquisitions. Both Analog and Color Graded Persistence can be used in either Standard or XY display. You can make eye diagrams and constellation displays using Persistence, and the most recent sweep can be displayed as a “vector” trace over the Persistence display. Persistence is activated when you select the DISPLAY SETUP “Persistence” menu (11–14).



Which Grid?

Grid styles, examples of which are shown on the following pages, offer a variety of ways to view one or more traces in either Standard or XY display. As many as eight traces and grids can be displayed in Standard mode using the “Octal” grid selection (see page 11–12). When Parameters are used, the special parameter-style grid comes automatically into play. Grid graticules are internally generated, so that the intensity of grids, as well as of waveforms and text, can be adjusted to the desired intensity. Grids can also be blended with displayed traces.

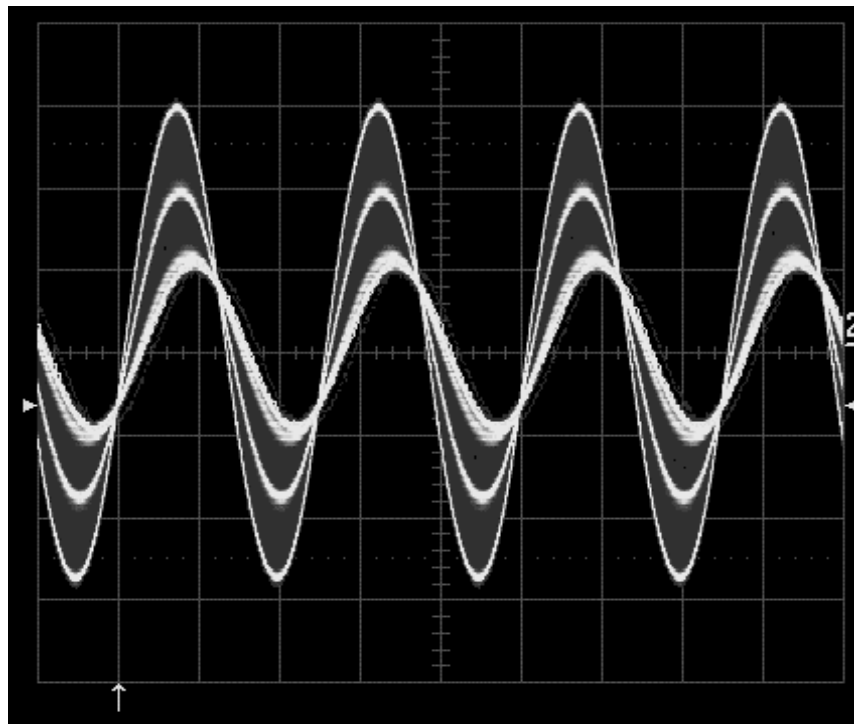

Standard Display — Single Grid

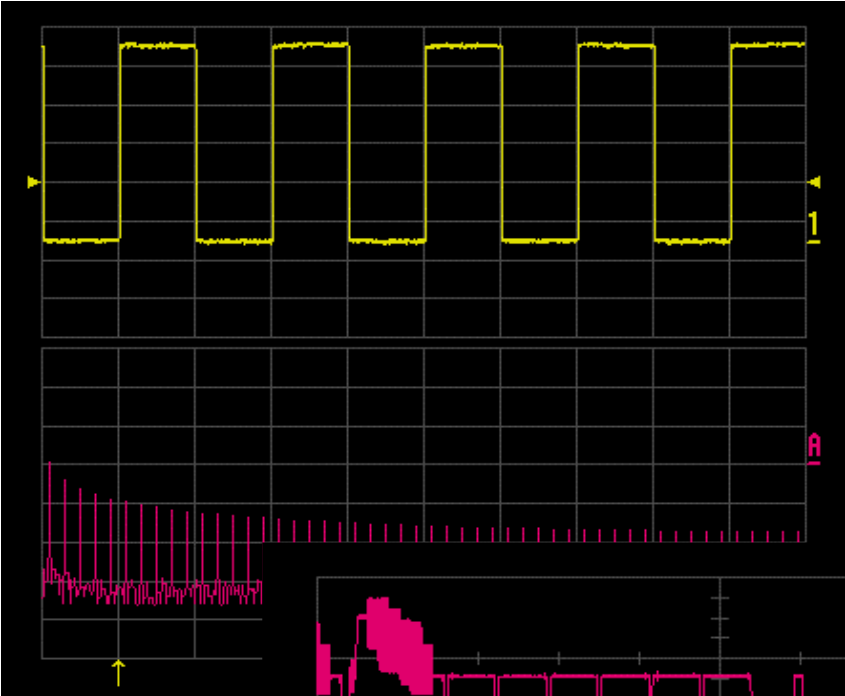

Standard Display — Dual, Quad Grid

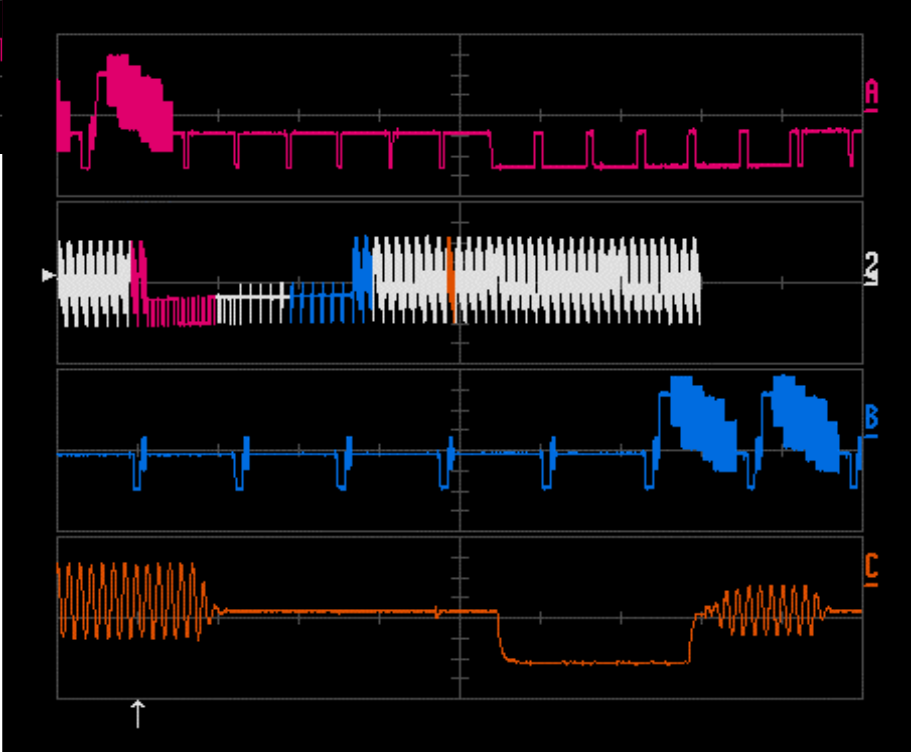



Display

Parameter Display — Quad Grid — Full-Screen Mode: trace information normally contained in the trace labels is arranged beneath the grid in Full Screen.

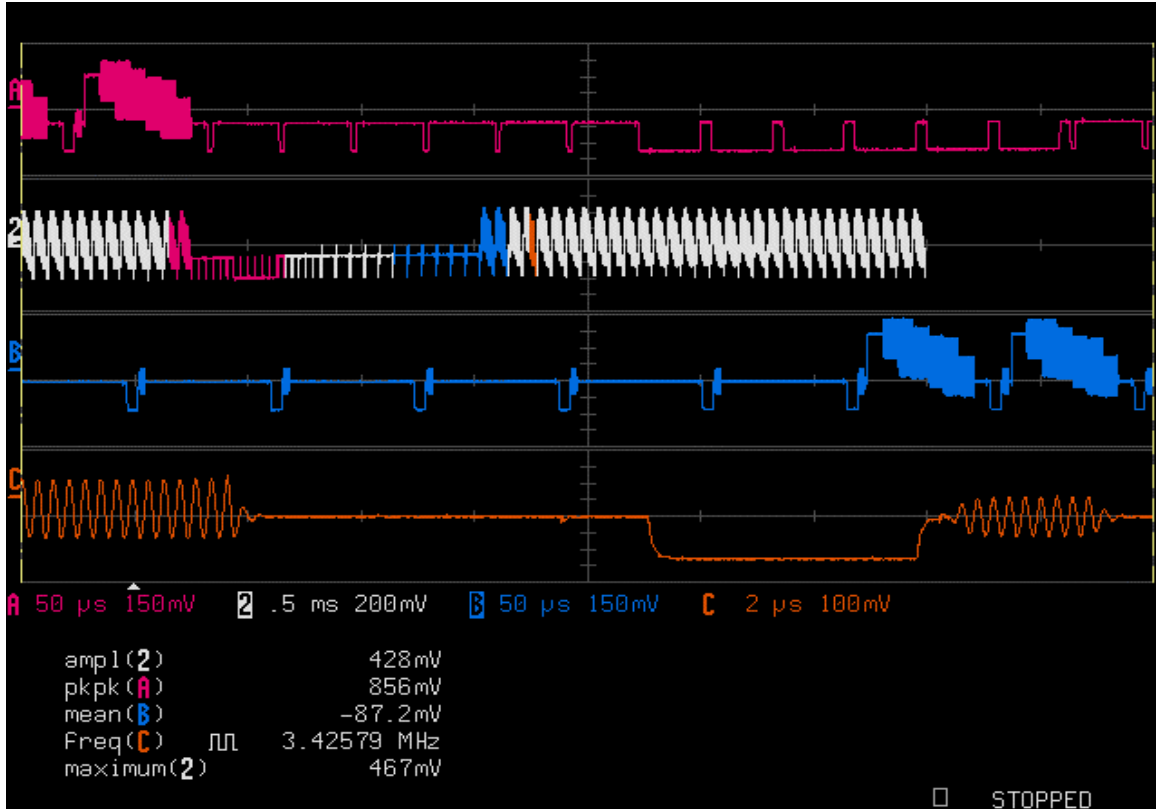

FULL
SCREEN

Pressing  expands the grid display to fill the entire screen. Pressing this button again returns the grid to its normal size. Pressing RETURN in Full Screen mode removes the menus from view so that waveforms can be viewed in their entirety. These reappear when you press one of the Menu-entry buttons.

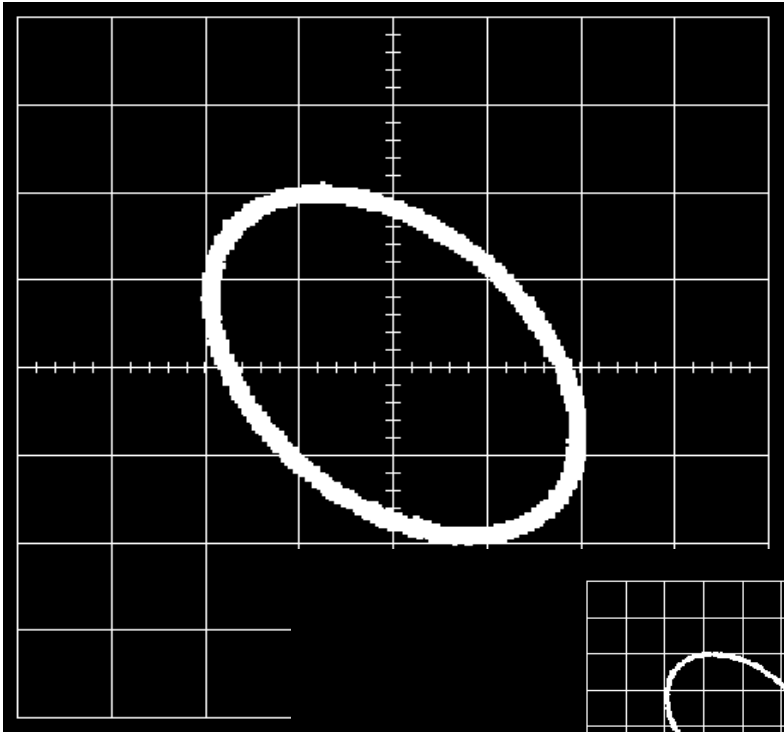

*XY Display grids — XY (left),
and XY + Dual (below)*

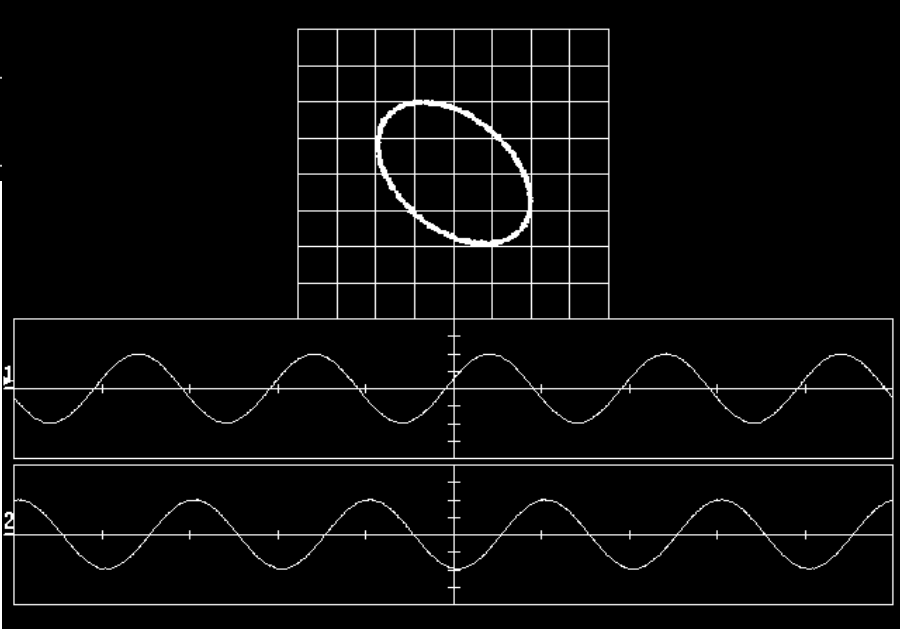



Displaying Multiple Traces You can display as many as eight traces at the same time with their respective trace labels and any combination of math, zoom, and memories. When “Octal” is selected from the “Standard” “Grids” menu (see next page), eight separate grids are made available. When more than four traces are displayed in Single-, Dual- or Quad-grid style, the accompanying trace labels become smaller so that as many as eight labels can be shown. However, in Octal the labels are always smaller.

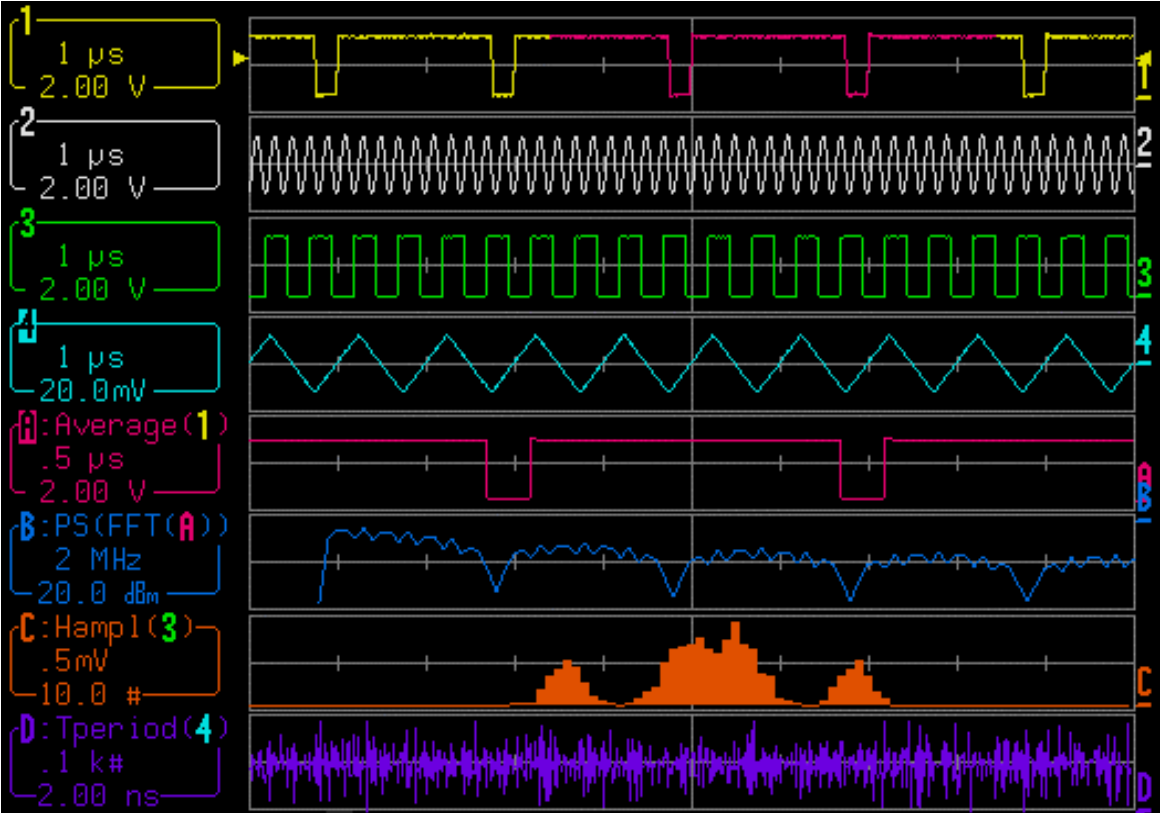

Octal style grid, with eight displayed traces and their labels.

DISPLAY SETUP — Standard

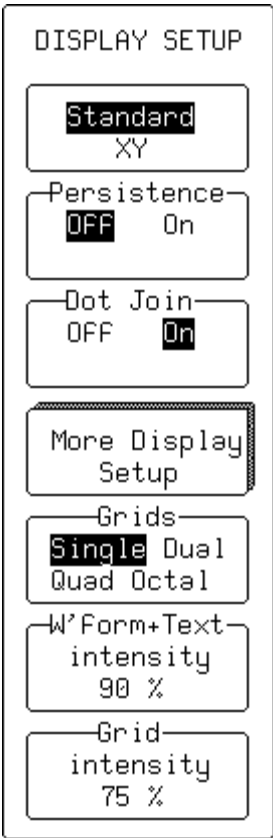

With **Standard** selected, these menus become accessible:

Persistence

This is for activating Persistence (see next menu). Its functioning is coupled to the ANALOG PERSIST button.

Dot Join

This is used to select Dot Join ON — connecting the sample points with a line segment — or OFF, when only the sample points are displayed when there are less than 400 points on the screen.

More Display Setup

This is used for accessing the MORE DISPLAY menus (see page 11–20).

Grids

This is for selecting the number of grids.

W'form + Text intensity

This adjusts the screen intensity for the waveform and associated text by means of the associated menu knob.

Grid

This adjusts the screen intensity of the grid by means of the associated menu knob.

Note: If “W'form + Text intensity” is turned down to 0%, the waveform and text disappear. Press the DISPLAY button to return automatically to 90% intensity. If “Grid” is turned down to 0%, press the “Grid intensity” menu button to return this intensity to 75%.

DISPLAY SETUP — Standard — Persistence On

```

DISPLAY SETUP
Standard
  XY
Persistence
  OFF On
  (InFinite)
Persistence
  Setup
More Display
  Setup
Grids
Single Dual
Quad Octal
For trace
  1 2 3 4 A B C
  D All
saturate at
  50.0 %
  (toggle zero)
  
```

With both **Standard** and “Persistence” **On** selected in the first menu, these menus appear:

Persistence

This is for activating Persistence. When **On**, this can be cleared and reset by pressing the CLEAR SWEEPS button or by changing any acquisition condition or waveform processing condition. This menu button toggles with the ANALOG PERSIST button.

Persistence Setup

Use this to access the “PERSISTENCE” menus (see next page)

More Display Setup

This is for accessing the “MORE DISPLAY” menus (see page 11–20).

Grids

This is for selecting the number of grids.

For trace

Use this to select any or all of the displayed traces — **On** (top menu) — for saturation adjustment.

saturate at

This is for selecting the percentage of saturation. A level of 100% corresponds to the color spectrum being spread across the entire depth of the persistence data map. At lower values, the spectrum will saturate (brightest color or shade) at the specified percentage value. Lowering the percentage causes the pixels to be saturated at a lower data intensity, and allows rarely-hit pixels that are not seen at higher percentages to become visible.

PERSISTENCE

```

PERSISTENCE
Last Trace
(show)
OFF  On
Persist For
0.5 s  1 s
2 s    5 s
10 s   20 s
InFinite
Persist
All traces
Top 2
Using
Analog
Color Graded
For trace
1 2 3 4 A B C
D All
saturate at
50.0 %
(zero toggle)
    
```

These menus appear when **Persistence Setup** is selected from DISPLAY SETUP.

Last Trace

Select **On** to show the last acquired trace.

Persist for

This is for selecting the persistence duration, in seconds.

The number of sweeps accumulated (up to one million) is displayed below the grid.

Persist

Use this to select whether persistence is applied to all traces or to the top two traces only.

Using

Use this to select the Persistence Mode. With **Analog** selected, each persistence data map is rendered to the screen in various intensities of the trace color. With **Color Graded**, all persistence data maps are rendered in a red-to-violet spectrum.

For trace

Use this to select any or all of the displayed traces — if **On** (top menu) — for saturation adjustment.

saturate at

This is for selecting the percentage of saturation. A level of 100% corresponds to the color spectrum being spread across the entire depth of the persistence data map. At lower values, the spectrum will saturate (brightest color or shade) at the specified percentage value. Lowering the percentage causes the pixels to be saturated at a lower data intensity, and allows rarely-hit pixels that are not seen at higher percentages to become visible.

DISPLAY SETUP — XY

When XY is selected in the first menu, these other menus appear.

DISPLAY SETUP

Standard
 XY

Persistence
 OFF On

XY
 Setup

More Display
 Setup

Grids
 XY only
 Single Dual

W' Form+Text
 intensity
 90 %

Grid
 intensity
 75 %

Persistence

This is for activating Persistence.

XY Setup

This is for accessing XY SETUP (see next page).

More Display Setup

This is for accessing the MORE DISPLAY menus.

Grids

Use this to select the grid style.

W'form + Text intensity

This adjusts the screen intensity for the waveform and associated text by means of the associated menu knob.

Grid intensity

This adjusts the screen intensity of the grid by means of the associated menu knob.

Note: If "W'form + Text intensity" is turned down to 0%, the waveform and text disappear. Press the DISPLAY button to return automatically to 90% intensity. If "Grid" is turned down to 0%, press the "Grid intensity" menu button to return this intensity to 75%.

XY SETUP

When the corresponding menu button for XY SETUP is pressed and when "Persistence" is **OFF**, these menus appear:

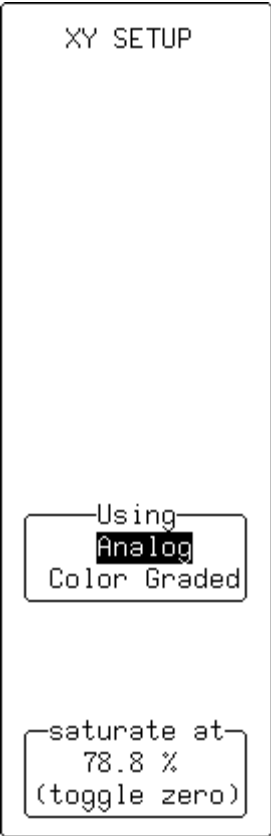

Using

Use this to select **Analog** or **Color Graded** persistence *for a single sweep*.

saturate at

This is for selecting the percentage of saturation. At lower values, the spectrum will saturate (brightest color or shade) at the specified percentage value. Lowering the percentage causes the pixels to be saturated at a lower data intensity, and allows rarely-hit pixels that are not seen at higher percentages to become visible.

DISPLAY SETUP — XY — Persistence On

DISPLAY SETUP

Standard

Persistence
 OFF On
 (InFinite)

XY-Persist
 Setup

More Display
 Setup

Grids
 XY only
 Single Dual

W'Form+Text
 intensity
 90 %

Grid
 intensity
 75 %

When **XY** is selected in the first menu and Persistence is activated, these menus appear:

Persistence

Use this to turn Persistence **On**.

XY-Persist Setup

This is for accessing XY SETUP using Persistence (see next page).

More Display Setup

This is for accessing the MORE DISPLAY menus.

Grids

This is for selecting the grid style.

W'form + Text intensity

This adjusts the screen intensity for the waveform and associated text by means of the associated menu knob.

Grid intensity

This adjusts the screen intensity of the grid by means of the associated menu knob.

Note: If "W'form + Text intensity" is turned down to 0%, the waveform and text disappear. Press the **DISPLAY** button to return automatically to 90% intensity. If "Grid" is turned down to 0%, press the "Grid intensity" menu button to return this intensity to 75%.

XY SETUP — XY-Persist Setup

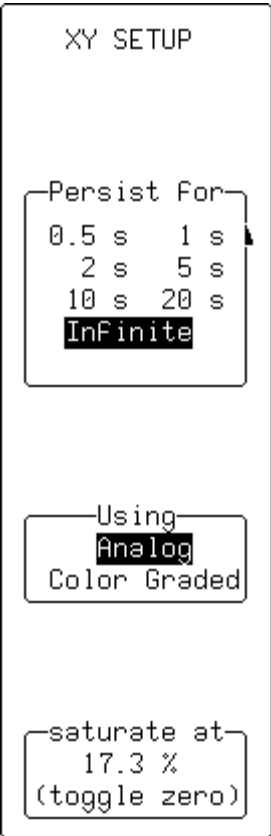

These menus appear when you press the corresponding menu button for "XY-Persist Setup."

Persist for

This is for selecting the persistence duration, in seconds. The number of sweeps accumulated — up to one million — is displayed below the grid.

Using

To select **Analog** or **Color Graded** Persistence.

saturate at

This is for selecting the percentage of saturation. A level of 100% corresponds to the color spectrum being spread across the entire depth of the persistence data map. At lower values, the spectrum will saturate (brightest color or shade) at the specified percentage value. Lowering the percentage causes the pixels to be saturated at a lower data intensity, and allows rarely-hit pixels that are not seen at higher percentages to become visible.

Controlling Color

MORE DISPLAY

Press the button alongside the “More Display Setup” menu to gain direct access to these menus.



Screen Saver Setup

This is for accessing the Screen Saver controls. When enabled, the built-in screen saver will blank the screen 10 minutes after the last use of a front panel control. This is a complete display shutdown of the internal screen, resulting in lower power dissipation and system noise. The external monitor, however, does remain active during the display shutdown. The front panel LED indicates that the scope is in the screen-saving STANDBY state. Press any front panel control to restore the screen.

Color Scheme

Use this to select from six preset (1 through 6), or four user (U1 through U4) color schemes. When a user-custom scheme is chosen, “CHANGE COLORS” is added to the list of menus, enabling the creation of personal color palettes and the assignment of colors to traces, grids, or any other displayed on-screen object or element (see box on facing page). It also allows preset schemes to be copied for easier customization.

CHANGE COLORS

This menu appears when you select one of the four custom color schemes from the COLOR SCHEME menu (above). It accesses the CHANGE COLORS secondary menu (see page 11–22).

Trace color

This is for selecting either **Opaque** or **Transparent**. When the latter is chosen, waveform objects are always visible and their overlapping regions automatically distinguished by a new and unique color. When dealing with traces of the same type, the foremost trace is described in the top-left trace label, the next in the second-from-top trace label, and so on in descending order towards the background and the bottom of the screen, respectively. This order can be changed by means of the CHANNELS TRACE ON/OFF buttons. For a variety of trace types, the order follows that described on page 11–3.

Measure Gate

This is used to turn **On** the Measure Gate function, which highlights the gated parameter region by making the trace in the region *outside* the parameter a neutral color.

Data Points

This is used to show the data (sample) points in **Normal** or **Bold** view.

Choosing Colors

The preset (“1–6”) and user-selected (“U1–U4”) custom color schemes give a particular color to each displayed object. Colors are assigned to the custom palettes through the CHANGE COLORS “Change” menu (see next page) for:

Background: The background color of the entire display area.

Trace 1...4: The color assigned to traces displaying Channel 1, 2, 3, or 4.

Trace A...D: The color assigned to Trace A, B, C, or D.

Grid: The default color of the grid.

Text: The color assigned to menus, acquisition status and non-single-source measurements.

Cursors: The color assigned to cursors.

Warnings: The color assigned to error and warning messages.

Neutral: The color designated as neutral (can be any color in user palettes), used in ‘Measure-Gate’ region highlighting.

Overlays: The color assigned to the menus overlaid on the grid in Full Screen mode.

CHANGE COLORS

This enables colors to be assigned to displayed objects, and color schemes to be customized.

```

CHANGE COLORS
in user color
scheme U1

Copy From
1 2 3 4 5 6
U1 U2 U3 U4

COPY SCHEME
1 to U1

Change
Trace 1
Trace 2
Trace 3
Trace 4
Trace A

color to
White
Cyan
Yellow
Green
Blue

```

Copy from

This is for copying one of the six preset color schemes (1 through 6) to a user color scheme (U1 through U4), or one user color scheme to another. Copying makes customizing easier by forming the basis of a personalized palette that can then be developed.

COPY SCHEME

This is for executing the copying of the preset scheme to the personal color palette.

Change

Use this to select a displayed object for color assignment (see box on previous page for details).

color to

This is for selecting the color to be assigned to the chosen object.

#

Printing, Mass Storage, and Other Utilities

UTILITIES

Press  to access the primary menus for:

- **Hardcopy settings**
- **Time and date settings for the real-time clock**
- **GPIB and RS-232-C settings**
- **Mass storage utilities (including copy and format and delete files)**
- **Special modes of operation (including offset behavior, sequence time-out, cursor units, autocalibration and Remote Control Assistant)**
- **Signal function at the CAL BNC connector (magnitude, frequency, shape, trigger out, pass/fail use)**

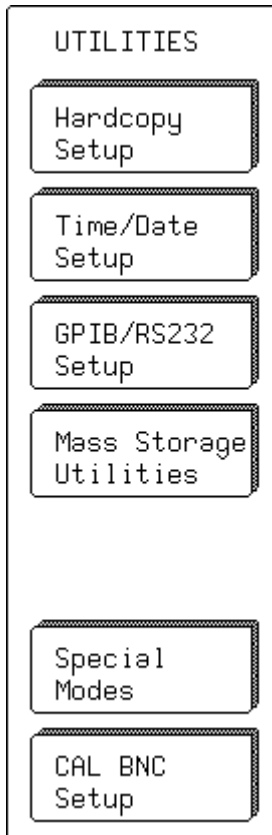

Hardcopy Setup (see page 12–2)

Use this to access secondary menu for viewing or changing printer settings.

Time/Date Setup (see page 12–4)

Use this to access the secondary menu for adjusting the real-time clock displayed in the upper left-hand corner of the screen.

GPIB/RS232 Setup (see page 12–5)

Use this to access the secondary menu for viewing or changing interface settings.

Mass Storage Utilities (see page 12–10)

Use this to access the MASS STORAGE UTILITIES menus.

Special Modes (see page 12–19)

Use this to access the SPECIAL MODES menus.

CAL BNC Setup (see page 12–23)

Use this to access the CAL BNC menus.

Hardcopy Setup

HARDCOPY

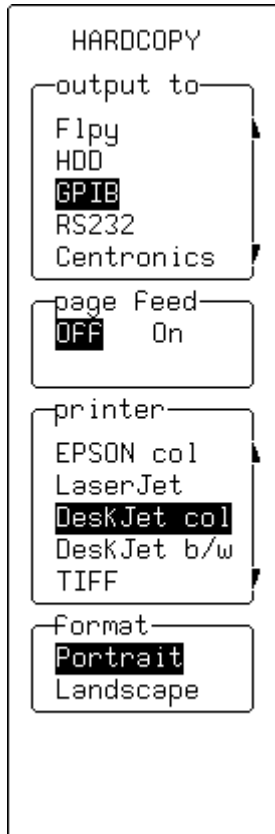

When you select "Hardcopy Setup" from UTILITIES these menus appear:

output to

Use this to select the output device. This menu shows the options installed in the instrument. The device can be a port (GPIB, RS232, or Centronics) to which a printer is connected, a storage unit such as a floppy drive or portable hard disk drive (HDD), or the internal printer. If it is a port, the GPIB & RS232 menus should be checked to ensure that settings are correct. File names are assigned automatically when you copy to a storage unit.

page feed

Select **On** to start a new page each time SCREEN DUMP is pressed.

Press  to make a copy of the screen display.

printer

Use this to select the type of printer (see Appendix A), plotter (HP 7470, HP 7550 only), or screen file protocols (TIFF, BMP, HPGL) by means of the corresponding menu buttons or knob.

format

This is for choosing "Portrait" or "Landscape" formats (availability is dependent on "printer" choice).

Background (not shown)

This menu becomes available when you choose "TIFF color," "BMP color," or "BMP compr." It is used to give a "Black" or "White" background to the hardcopy reproduction.

plot size (not shown)

Available only when a plotter is selected, this submenu offers these choices of size: A4 (11" × 8.5") or A5 (8.5" × 5.5").

pen number (not shown)

Available only when a plotter is selected, this submenu is used for choosing the number of pens installed (the instrument assumes that the pens are loaded consecutively in the lower slots).

HARDCOPY — Internal Printer

OPTIONAL ON MOST MODELS

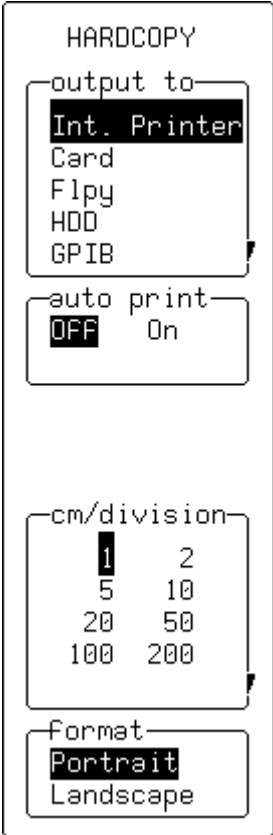

output to

Use this to select the device to which the instrument is to output data: in this case, the optional **Int. Printer**. This menu shows the options installed in the instrument. The device can be a port (GPIB, RS232, or Centronics) to which a printer is connected, a storage unit such as floppy drive or portable hard disk drive (HDD), or the internal printer. If it is a port, the "GPIB & RS232" menu should be checked to ensure that settings are correct. File names are assigned automatically when you copy to a storage unit.

auto print

When **On**, this generates a hard copy of the screen and sends it to the internal printer after every acquisition.

cm/division

This is for selecting the expansion factor.

format

This is for choosing "Portrait" or "Landscape" formats.

Note: A "persistence" trace cannot be expanded, nor can cursors be shown on an expanded printout.

Time/Date Setup

TIME/DATE

TIME/DATE

SET CLOCK
FORWARD ONE
HOUR (SPRING)

SET CLOCK
BACKWARD ONE
HOUR (FALL)

LOAD CHANGES
NOW

Hour Min Sec
09:32:39

Day Mnth Year
9 OCT 1996

When you select "Time Date Setup" from UTILITIES these menus appear:

SET CLOCK FORWARD ONE HOUR

This is for changing to Daylight Savings Time.

SET CLOCK BACKWARD ONE HOUR

This is for changing back to Standard Time.

LOAD CHANGES NOW

Use this to activate the changes made with the "Hour Min Sec" and "Day Mnth Year" buttons and knobs (see below).

Hour/Min/Sec

Use the corresponding menu button to toggle between **Hour**, **Minutes**, and **Seconds**; and the associated menu knob to adjust the value.

Day/Mnth/Year

Use the corresponding menu button to toggle between **Day**, **Mnth**, and **Year**; and the associated menu knob to adjust the corresponding value.

GPIB/RS232 Setup

When you select “GPIB/RS232 Setup” from UTILITIES, you can use the RS-232-C port on the rear panel for remote operation of the oscilloscope, and for direct interfacing to a hard-copy device to output displayed waveforms and other screen data. See the illustration on the next page for RS-232 printer cabling, and “Data to PC” in the Hands-On Guide for computer nine-pin communication cabling for PC.

A printer unit connected to the scope through the RS-232-C port can be controlled from a host computer using the scope’s GPIB port. The oscilloscope’s built-in drivers also allow hard copies to be made without an external computer.

The Remote Control Assistant feature allows automatic detection of errors during remote control operation (see page 12–20).

RS-232-C Connector Pin Assignments		
DB9 Pin No.	Line Name	Description
3	T × D	Transmitted Data (from the oscilloscope).
2	R × D	Received Data (to the oscilloscope).
7	RTS	Request To Send (from the oscilloscope). If the software Xon/Xoff handshake is selected, it is always TRUE. Otherwise (hardware handshake) it is TRUE when the oscilloscope is able to receive characters and FALSE when the oscilloscope is unable to receive characters.
8	CTS	Clear To Send (to the oscilloscope). When TRUE, the oscilloscope can transmit; when FALSE, transmission stops. It is used for the oscilloscope output hardware handshake.
4	DTR	Data Terminal Ready (from the oscilloscope). Always TRUE.
5	SIG GND	Signal Ground
Corresponds to a DTE (Data Terminal Equipment) Configuration		

GPIB & RS232

GPIB & RS232

Remote Control From
 GPIB RS232

RS232 Mode
 7-bit 8-bit

Parity
 none odd even

Stop bits
 1 2

Baud Rate
 300 1200
 2400 4800
 9.6K 19.2K
 57.6K 115.2K

GPIB Device (Address)
 4

When "GPIB/RS232 Setup" is selected from UTILITIES these menus appear:

Remote Control from

This is for selecting the port for remote control.

RS232 Mode

Use this to select **7-bit** or **8-bit** mode for RS-232 communication. When **RS-232** is selected, the GPIB interface is in "Talk Only" mode. Any change becomes effective immediately.

Parity

Use this to select **odd**, **even**, or **none** for RS-232 communication.

Stop bits

This is for selecting the number of stop bits for RS-232 communication.

Baud Rate

Use this to set the Baud Rate for RS-232 communication using the associated menu knob.

GPIB Device (Address)

Use this to choose the appropriate GPIB address.

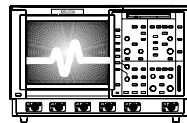

Scope

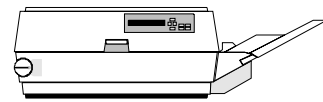
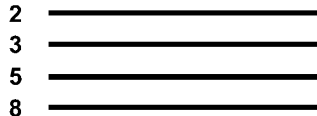

Printer

RS-232 cabling can be used in almost every case (for computer cabling see "Transferring Data to PC" in the "Hands-On Guide").

Mass Storage Utilities

When you select “Mass Storage Utilities” from UTILITIES, the “MASS STORAGE” menu group appears (see page 12–10). This menu gives access to the mass storage file system controls. The system supports storage and retrieval of data files to and from memory cards, floppy disks, and removable hard disk drive (HDD) media.

Memory Card Format

The Memory Card structure, based on the PCMCIA II / JEIDA 4.0 standard and consists of a DOS partition containing files, as in any DOS floppy or hard disk. The oscilloscope formats the card in segmented contiguous sectors, each of 512 bytes. The scope does *not* support error detection algorithms such as CRCs or checksum inserted between the sectors. When this is done the instrument may only be able to read from, but not write to, the card.

Floppy Disk Format

The floppy supports DOS 1.44 MB and 720 kB formats.

Hard Disk (HDD) Format

The removable hard disk structure is based on the PCMCIA III / JEIDA 4.0 standard. The medium is arranged as a DOS partition containing files, as in any DOS floppy or hard disk.

The HDD format uses 512 bytes per sector and four sectors per cluster. One cluster is the minimum file size: any files smaller than 2048 bytes in size will still use one cluster's allocation of 2048 bytes of disk space. A total of 500k ASCII records can be saved to the HDD portable hard drive.

Subdirectories

All files are written to, and read from, the current working directory. The default name of the working directory is LECROY_1.DIR. This directory is automatically created when the media are formatted. If the media are formatted elsewhere — for instance, on a PC — the directory will be created the first time a file is saved to the memory card, floppy disk, or removable hard disk.

The working directory can be changed to any valid DOS directory name, using the file-name preferences menu. All working directories are created as sub-directories from the root directory.

The maximum number of files allowed in any one directory is 2400.



File-naming Conventions

As in MS-DOS, the file name can take up to eight characters followed by an extension of three characters. A file is treated as:

- a panel setup if its extension is PNL
- a waveform if its extension is a three-digit number
- a waveform template if its extension is TPL
- a hardcopy if its extension is TIF, BMP, or PRT
- an HPGL plot file if its extension is PLT

See also the key to terms, below.

The instrument has a predefined naming convention for the eight-character file and directory names. These default names can be customized, as shown in this table. If the new file being stored has the same name as an existing file on the same storage medium, the old file will be deleted.

Type	Default Name	Customized Name
Manually stored waveform files	Stt.nnn	xxxxxxx.nnn
Automatically stored waveform files	Att.nnn	xxxxxxx.nnn
Panel files	Pnnn.PNL	xxxxnnn.PNL
Hardcopy files	Dnnn.TIF Dnnn.BMP Dnnn.PRT Dnnn.PLT	xxxxnnn.TIF xxxxnnn.BMP xxxxnnn.PRT xxxxnnn.PLT
Template files	LECROYv.TPL	Cannot be changed
Directory name	LECROY_1.DIR	xxxxxxx
Spreadsheet	Sttnnn.TXT	xxxxnnn.TXT
Matlab	Sttnnn.DAT	xxxxnnn.DAT
Mathcad	Sttnnn.PRN	xxxxnnn.PRN

Key to Terms

x	<i>any legal DOS file-name character</i>	w	<i>the template version number: for example, for a version 2.2, the template is saved as LECROY22.TPL</i>
tt	<i>the trace name of C1, C2, C3, C4, TA, TB, TC, TD</i>	TIF BMP	<i>hardcopy graphic image files</i>
nnn	<i>a 3-digit decimal sequence number starting at 001 that is automatically assigned</i>	PRT	<i>hardcopy printer files.</i>
PLT	<i>HPGL plotter/vector files</i>		

Auto-Store Waveform File Naming

The default notation for waveform files is Stt.nnn for manually stored files and Att.nnn for automatically stored files, the characters S and A representing the two storage methods, respectively.

When automatically generating a file name, the system uses the assigned name plus a three-digit sequence number. If the assigned waveform name is already in the default 'Stt' form — such as SC1, STB — the name will be modified to the 'Att' form: AC1, ATB, and so on. All other user-assigned names remain as entered.

More on Auto-Stored Files

If **Fill** is selected and default names are used, the first waveform stored will be Axx.001, the second Axx.002, and so on. This continues until the storage medium is filled, the file number reaches 999, or there are more than 2400 files in the current working directory.

If **Wrap** is selected, the oldest auto-stored waveform files will be deleted whenever the medium becomes full. The remaining auto-stored waveform files will be renamed: the oldest group of files will become "Axx.001," the second oldest "Axx.002," and so on.

The current sequence number is deduced from inspection of all file names in the working directory, regardless of file type — panel, hard copy, or waveform. The highest occupied numeric file-name extension of the form 'nnn' is determined, and the next highest number is used as the current generation number for storage operations.

Deleting Files

When a file generation is deleted, all files designated with the three-digit sequence number of the file-name extension will be deleted, regardless of file type.

Media Size/Storage Availability

The mass-storage file system indicates media size and storage availability in kbytes where 1 kbyte = 1024 bytes. Many media manufacturers specify the available storage in Mbytes where 1 Mbyte = 1 million bytes. This results in an apparent mismatch in specified versus actual media storage availability, when in fact the availability in bytes is identical.

Write Protect Switch

If the write-protection switch of the card or floppy disk being used has been set, the message "Device is Write Protected" will be displayed on the upper part of the grid whenever the medium is accessed for writing.

SRAM Card Battery

The SRAM memory card contains a battery for preserving data. When this needs replacing, the message "BAD BATTERY" appears. The battery should be changed while the memory card is still in the oscilloscope to prevent loss of information. To gain access to the battery, remove the panel on the bottom edge of the card by removing the small screw.

MASS STORAGE

This calls up the primary menus for controlling mass storage. The range of "UTILITIES" available depends on the options installed:

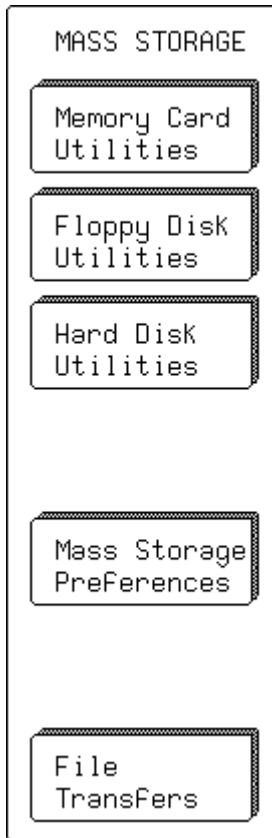

Memory Card Utilities *(OPTION)*

Use this to delete files, or to format or copy a machine template onto memory card. (The Utilities menus accessed by selection of this Memory Card menu are similar to those accessed for Floppy Disk, shown on the following pages.)

Floppy Disk Utilities

Use this to delete files, format, or copy a machine template onto floppy disk. The examples on the following pages illustrate this selection.

Hard Disk Utilities *(OPTION)*

Use this to delete files, format, or copy a machine template onto hard disk. See page 12-14.

Mass Storage Preferences

Use this to set, add, or delete a working directory, or to customize file names. See page 12-15.

File Transfers *(IF MORE THAN ONE MASS-STORAGE DEVICE IS AVAILABLE)*

This is for copying files from one storage device to another. See page 12-18.

FLPY UTIL

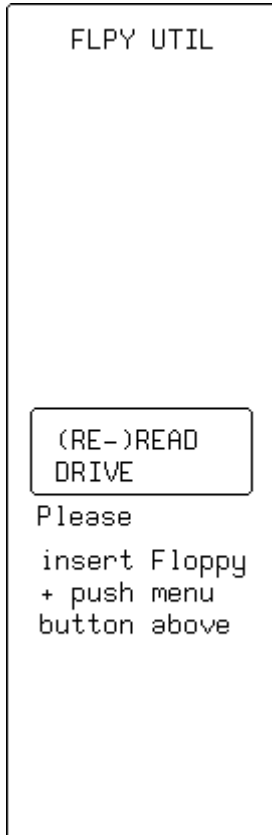

These menus appear when "Floppy Disk UTILITIES" is selected from MASS STORAGE and

- a floppy has been newly inserted, or
- there is no floppy in the drive

(RE-)READ DRIVE

Use this to read the floppy disk and display directory contents.

FLPY UTIL

```
FLPY UTIL
-----
TEMPLATE AND
FORMATTING
LECROY_1.DIR
12-Jun-96
  7 Files
Size 1440K
Free 1164K

DO DELETE
G703ONE.004

File
G703ONE 004
G703ZERO 004
ONE      PNL
ZERO     PNL
SC2      007
10-Oct-96
09:52:02
Size 409
```

Once the floppy disk has been read, these menus appear. They display information about the installed storage media:

- last "format" date and time
- memory size and available free space
- date, time, and size information of the selected file on the disk

TEMPLATE AND FORMATTING

Use this to access a secondary menu for formatting storage media or for copying the machine template to it. The template is an ASCII text file that contains all information required for decoding the descriptor part of a binary waveform.

DO DELETE

Use this to delete the file selected in the "File" menu (see below).

File

This is for selecting the file to be deleted, using the associated menu knob or buttons.

FORMAT FLPY

```
FORMAT FLPY
!FORMATTING
ERASES ALL
INFO ON FLPY

PERFORM
FLPY FORMAT

Density
1.44 MB (HD)
720 KB (DD)

COPY TEMPLATE
TO FLPY
```

These menus appear when "TEMPLATE AND FORMATTING" is selected from FLOPPY UTIL.

PERFORM FLPY FORMAT

Use this to format the floppy in DOS format with an interleave factor of two, which optimizes throughput to and from the scope.

Density

This menu, which appears only in "FORMAT FLOPPY," is used for selecting density: **1.44 MB (HD)** or **720 kB (DD)**.

COPY TEMPLATE TO

This is for copying the machine template to the medium. The machine template is an ASCII text file that contains all the information required to decode the descriptor part of a binary waveform.

FORMAT HDD

```
FORMAT HDD
!FORMATTING
ERASES ALL
INFO ON HDD

QUICK FORMAT
(~15 sec)

FULL FORMAT
(~10 min)

COPY TEMPLATE
TO HDD
```

These menus appear when “MASS STORAGE,” “Hard Disk UTILITIES,” and “TEMPLATE AND FORMATTING” are selected.

QUICK FORMAT

Use this to quickly (15 seconds) clear the portable hard disk drive.

FULL FORMAT

Use this for a complete formatting of the HDD, which is recommended if the disk is non-readable.

COPY TEMPLATE TO

This is for copying the machine template to the medium. The machine template is an ASCII text file that contains all the information required to decode the descriptor part of a binary waveform.

PREFERENCES

These menus appear when "MASS STORAGE," "Mass Storage Preferences," are selected and used for:

- selecting the working directory
- deleting a directory
- accessing the "File Name Preferences" menu
- accessing the "Add New Directory" menu



on drive

This is used for selecting the medium.

File Name Preferences

This is used to access the secondary menu for defining custom names for waveform, setup, or hardcopy files (see next page).

DELETE THIS DIRECTORY

This is used to delete the directory selected in **work with** menu (see below).

work with

This is for selecting the directory to be used for file storage and retrieval.

Add new Directory

This is used to access a secondary menu to add a new directory.

FILENAME PREF

FILENAME PREF
 SC1.xxx
 to be set to:
 TE~~A~~.xxx

RESTORE
DEFAULT NAME

ENTER NEW
FILE NAME

BACKSPACE

INSERT

character
56789-~~A~~BCDEFG

File Type
Channel 1
Channel 2

This menu group appears when “File Name Preferences” is selected from the preceding menu, and is used for defining custom names for waveform, setup, or hardcopy files.

to be set to:

Use this to select the character for modification.

RESTORE DEFAULT NAME

This is for restoring the file type selected in the “File Type” menu (see below) to its default name.

ENTER NEW FILE NAME

This is used to validate the newly defined name.

BACKSPACE

This is for moving back one space and erasing the previous character.

INSERT

Use this to move forward to create a space for insertion of a character.

character

This is for selecting a character, using the menu knob.

File Type

Use this to select the file type to customize.

NEW DIRECTORY

NEW DIRECTORY
New Directory
on Card:
DA

MAKE THIS
DIRECTORY

BACKSPACE

INSERT

character

789-AB DEFGHI

This is used to define a new directory with a custom name.

New Directory on Card:

This is for creating a new directory.

MAKE THIS DIRECTORY

This is for validating the new directory.

BACKSPACE

Use this to move back one space and erase the previous character.

INSERT

This is for moving forward to create a space for the insertion of a character.

character

This is for selecting a character, using the menu knob.

COPY FILES

```
COPY FILES
Direction
Card -> Flpy
Flpy -> Card
Card -> HDD
HDD -> Card
Flpy -> HDD
Which Files
Panels
Prints
WaveForms
All Files
DO COPY
!OVERWRITES
FILES WITH
SAME NAME
```

These menus, which appear when “MASS STORAGE” “File Transfers” is selected, are used to copy files from one medium to another.

Direction (*DEPENDING ON OPTIONS INSTALLED*)

Use this to select the source (copy from) and destination (copy to).

Which files

This is for selecting the type of file for copying.

DO COPY

This executes copying.

Special Modes

When you select “Special Modes” from UTILITIES, these menus become available (not all selections may be available).

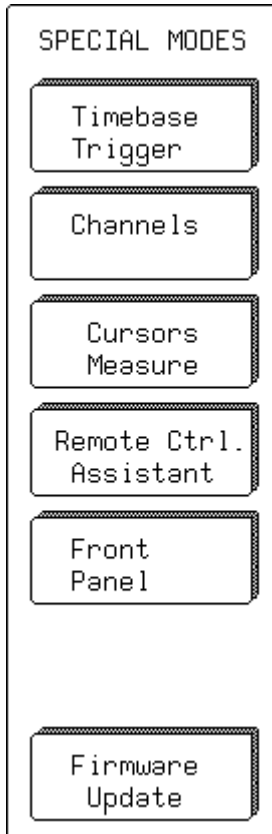

Timebase Trigger accesses:

➤ **AUTO sequence**

This is for specifying the time-out in Sequence mode, by means of the associated menu knob to change the value.

Channels accesses:

On GAIN Changes, all OFFSETS fixed and

➤ **In**

This is for specifying the offset behavior of a gain (VOLTS/DIV) change. The offset can be fixed in **Volts** or vertical **Divisions**.

➤ **Automatic Recalibration**

Use this to set the automatic recalibration **ON** or **OFF**. The default setting is **ON**. Turning this off may speed up the acquisition, but during that time calibration is not assured.

➤ **Global BWL**

This is used to control the Global Bandwidth Limit. When **On**, the chosen bandwidth limit applies to all channels; when **Off**, a bandwidth limit can be set individually for each channel. See Chapter 5, “Coupling.”

Cursors Measure Accesses:

➤ **Read time cursor amplitudes**

This is for selecting from “In” the time cursor amplitude units in **Volts** or **dBm**.

Remote Ctrl. Assistant

This accesses the “RC ASSISTANT” menus (see next page)

Front Panel

This accesses the “USER PREF’S” menu group (see page 12–21).

Firmware Update

This accesses the “FLASH UPDATE” menu (see page 12–22).

RC ASSISTANT

Used for monitoring remote commands received through the GPIB and RS-232 remote control ports, the Remote Control Assistant helps debug communications between the oscilloscope and the PC. When activated, it displays a log of the dialog taking place through the remote control ports of the oscilloscope. When a communication error occurs, RC Assistant gives the additional message "Remote Control: problem detected and logged."

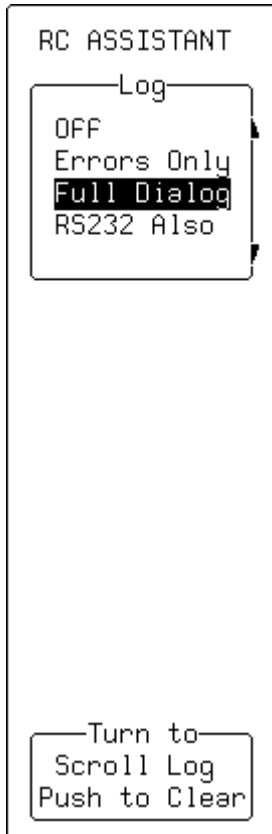

Log

Use this to select:

Off — The RC Assistant will *not* capture any remote commands.

Errors Only — This setting displays only wrong or incomplete commands received through any remote control port (this is the default setting after power-on).

Full Dialog — This setting captures all remote commands received through any remote control port and displays up to 100 lines of dialog, after which lines are overwritten on a first-in, first-out basis.

RS232 Also — This setting logs the full dialog and sends it to a recording device connected to the RS-232 port. When this is used, commands can only be received through the GPIB port.

See also the COMM_HELP and COMM_HELP_LOG commands in the Remote Control Manual.

Turn to

Turn the knob associated with this menu to enable scrolling through the log. Push the corresponding menu button to clear the log entirely.

USER PREF'S

This lets you customize the operation of front panel controls.

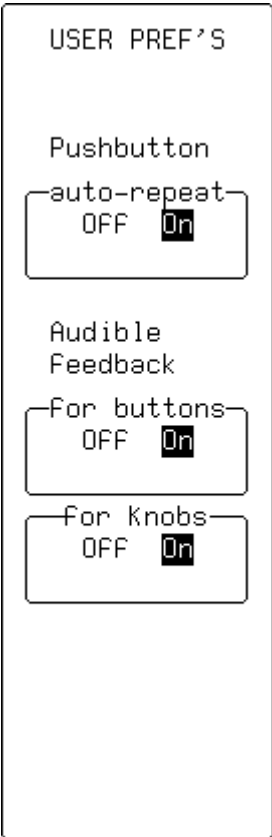

Pushbutton

auto-repeat

When this is **On**, all front panel buttons when pressed and held in will cursor sequentially through all the choices in their respective menus.

Audible

feedback

for buttons

When **On**, an audible beep will sound when you press any front panel button.

for Knobs

When **On**, an audible beep will sound when you turn any front panel knob.



FLASH UPDATE

These menus allow updating of the oscilloscope with new software. Shown here is the full screen warning message displayed when "FLASH UPDATE" has been selected from "SPECIAL MODES." The second menu is called "Update Flash" on **LC564, LC584, AND LC684 SERIES** oscilloscopes.

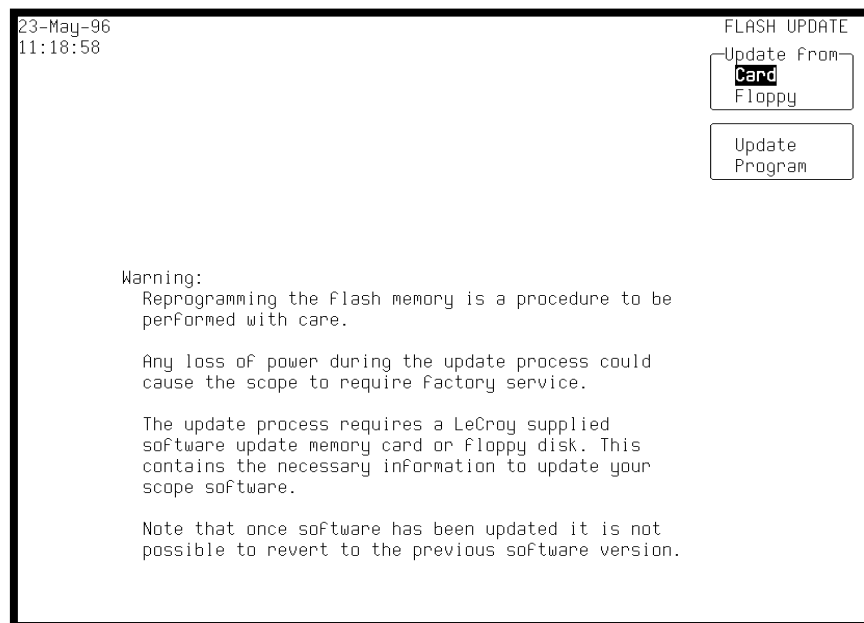

CAL BNC Setup

CAL BNC OUT

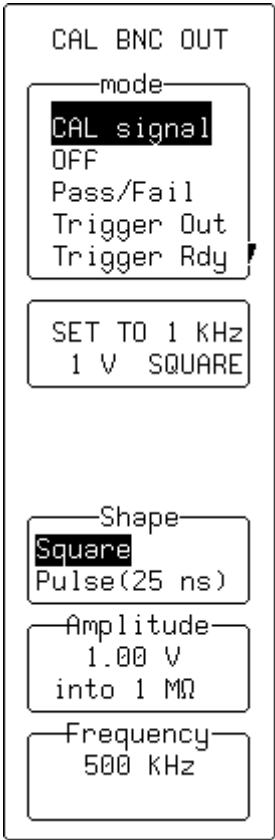

When you select “CAL BNC Setup” from UTILITIES, you can choose the type of signal output at the CAL BNC connector. You can also choose the frequency, amplitude, and pulse shape of the calibration signal.

In addition, the CAL BNC connector can be used to provide a pulse:

- as an action for PASS/FAIL testing
- at the occurrence of each accepted trigger event (Trigger Out)
- when the scope is ready to accept a trigger event (Trigger Rdy)

Moreover, a DC level in the range 0.05 V to 1 V in 1 MΩ can be selected.

When the instrument is switched on, the calibration signal is automatically set to its default state: 1 kHz, 1 V square wave.

mode

Use this to select the type of signal.

SET TO

Use this to reset the CAL BNC output to its default state.

Shape

Use this to select the form of the calibration signal.

Amplitude

This is for setting the desired high level for all CAL BNC applications, using the associated knob. If the BNC output is connected to an input channel with 50 Ω, the amplitude will be halved.

Frequency

This is for setting the desired frequency of a CAL signal in the range 500 Hz to 2 MHz, using the associated knob.

#



BLANK PAGE

Waveform Store

STORE W'FORMS

```

STORE W'FORMS
Data Format
Binary ASCII

Auto-Store
OFF
Wrap Fill

DO STORE
(1->Card)

store
1 2
3 4
A B
C D
All displayed

to
M1 M2 M3 M4
Card Flpy HDD
  
```

Press WAVEFORM  to store waveforms to internal memory (M1, M2, M3, or M4) in LeCroy's binary format. You can also store waveforms in binary or ASCII format on floppy disk, memory card, or removable hard disk (HDD) where available.

When **Binary** and **Flpy** (or one of the optional media is selected), the menus shown on this page appear. When an internal memory (M1 to M4) is selected, however, neither the "Data Format" nor "Auto-Store" menus appear. In either case, the waveform will be stored automatically in the selected memory in binary format when you press the "DO STORE" menu button.

When **ASCII** is selected (as shown on the next page) the scope will store the waveform in an ASCII format. But this will create an output file requiring 10 to 20 times the disk space of the original LeCroy binary file. Furthermore, waveforms stored in ASCII format cannot be recalled to the scope.

Note:

- *The capacities of the Reference and Zoom & Math memories each match those of the acquisition memories. For every unit of record length per channel, a point can be stored in any one of the four M reference memories, and the same number of points for each "Zoom & Math" trace.*
- *When more acquisition memory is achieved by combining channels, a single long trace can consume all the instrument's Reference memory or "Zoom & Math" trace capacity. If this happens, a warning message will be displayed to prevent the accidental storage of a new trace to a reference memory already in use.*

WAVEFORM STORE & RECALL

```
STORE W'FORMS
Data Format
Binary ASCII
(Spreadsheet)

Setup ASCII
Format

Auto-Store
OFF
Wrap Fill

DO STORE
(1->Card)

store
1 2
3 4
A B
C D
All displayed

to
Card Flpy HDD
```

Data Format

This is for choosing the data format, as described on the previous page. When **ASCII** is selected, the primary "Setup ASCII Format" menu appears immediately beneath this menu, giving access to the secondary "ASCII SETUP" menu (see next page). When **Binary** is selected, the waveform is stored in binary format.

Setup ASCII Format

This appears only when **ASCII** is highlighted in "Data Format," as shown here. It is used for accessing the secondary "ASCII SETUP" menu (see next page).

Auto Store

This is for automatically storing waveforms after each acquisition. **Fill** stores until the medium is filled, while **Wrap** stores continuously, discarding the oldest files on a first-in, first-out basis.

DO STORE

This stores in accordance with specifications made in the "store" and "to" menus (see below).

store

This is for selecting the waveform. **All displayed** can only be selected when you are storing on optional storage media.

to

Use this to select the internal memories **M1**, **M2**, **M3**, or **M4**, when "Binary" is selected in the "Data Format" menu, as shown on the previous page. Alternatively, select the optional **Card**, **Flpy**, or **HDD**, when **ASCII** is selected from the "Data Format" menu, as shown here.

ASCII SETUP

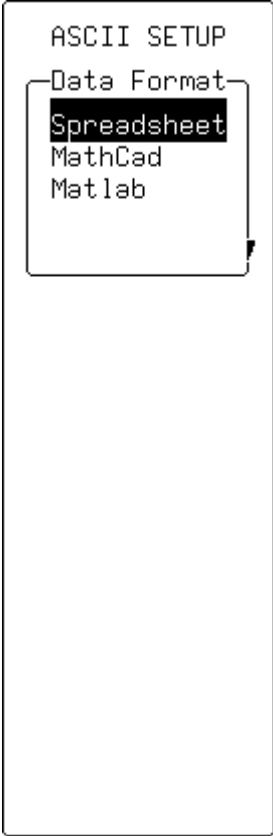

Data Format

This secondary menu, accessed through SETUP ASCII FORMAT, offers a choice of ASCII formats. (For details on each format, see Appendix E).



Waveform Recall

RECALL W'FORM

RECALL W'FORM

From

Memories HDD
Card Flpy

DO RECALL
M1 -> A

From Memory

M1
M2
M3
M4

to

A B C D

Press WAVEFORM  to recall a waveform from internal memory, floppy, or the optional memory card or removable hard disk (HDD).

from

Use this to select the storage medium from which to recall, internal **Memories** in this case.

DO RECALL

Use this to execute recall based on the selections made in the “from Memory” and “to” menus (see below). At the same time it resets the horizontal and vertical positions as well as the zooms, showing the full contents of the memory at its original magnification.

from Memory

This is for selecting the source memory.

to

Use this to select the destination trace.

Note: Performing a recall operation from an internal memory to Trace A–D overrides any previous definition of the destination trace.

RECALL W'FORM

```

RECALL W'FORM
  From
  Memories HDD
  Card Flpy
  Directory:
  LECROY-1.DIR

  10-Oct-96
  09:52:02
  Size 409

  DO RECALL
  G703ONE.004

  File
  G703ONE 004
  G703ZERO 004
  SC2 007
  SC3 007
  SC4 007

  to
  M1 M2 M3 M4
  All M
  
```

FLOPPY DISK OR OPTIONAL STORAGE DEVICE

from

This selects the device or medium on which the file is stored: **HDD**, **Card**, or **Flpy**.

DO RECALL

Use this to execute recall based on the selections made in the "File" and "to" menus (see below).

File*

This selects the file in which the waveform is stored, using the associated menu knob.

to

This is for selecting the destination memory. If **All M** is selected, up to four files with the same three-digit numeric extension as the current "File" selection will be recalled into memories M1 to M4.

#

* The files listed will be those in the current working directory.



WAVEFORM STORE & RECALL

BLANK PAGE

Cursors: Tools for Measuring Signal Values

The cursors are basic and important tools for measuring signal values.

In Standard Display Mode, **Amplitude** (voltage) cursors, represented by dashed lines spanning the width of the screen, move up and down the grid *pixel by pixel*.



Time cursors, represented by arrows or cross-hair markers that move along the waveform (see symbols at left), can be placed at a desired time to read the amplitude of a signal at that time, and moved to *every point acquired*.

When a Time cursor is placed on a data point, a cross-bar appears at the tail of the arrow, and at top and bottom of the cross-hair marker.

In **Absolute** mode a single cursor is used. Readings for amplitude (using Amplitude cursors) or time and amplitude (using Time cursors) can be displayed at the cursor location. Measured voltage amplitudes are relative to ground; measured times are relative to the trigger point.

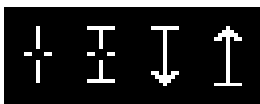

In **Relative** mode, a pair of Amplitude or Time cursors is used, providing readings on the difference between the two in amplitude, or time and amplitude, respectively.

Amplitudes are shown in the Trace Label for each trace. When Time cursors are used, the time is shown below the grid. And in Relative Mode the frequency corresponding to the time interval between the cursors is also displayed there.

When there are few data points displayed, Time cursor positions are linearly interpolated between the data points. Time cursors move up and down along these straight-line segments.

Cursors and Persistence

When using Persistence, Amplitude cursors are the same as in Standard Display (see above). Time cursors are vertical bars spanning the height of the screen and moving across it.



CURSORS/MEASURE & Parameters

Cursors in XY Display

In XY Display, Absolute Amplitude cursors appear as horizontal and vertical bars that can be moved up and down and side-to-side across the screen. Relative Amplitude cursors are pairs of bars that move in the same way. Absolute and Relative Time cursors behave as they do in Standard Display.

Combinations of the amplitude values are shown on the left-hand side of the grid in the following top-to-bottom order:

1. ΔY value / ΔX value..... Ratio
2. $20 * \log_{10}$ (ratio) Ratio in dB units
3. ΔY value * ΔX value..... Product
4. $f = \arctan (\Delta Y / \Delta X)$
range $[-180^\circ$ to $+180^\circ]$ Angle (polar)
5. $r = \sqrt{\Delta X * \Delta X + \Delta Y * \Delta Y}$ Radius (distance to origin)

The definition of ΔX and ΔY depends on the cursor used. The table below shows how ΔX and ΔY are defined for each type of measurement.

Cursors					
	AAbs	ARel	TAbs		TRel
			Org = (0,0)	Org = $V_{XOffset}$ $V_{YOffset}$	
ΔX	$V_{XRef} - 0$	$V_{XDif} - V_{XRef}$	$V_{XRef} - 0$	$V_{XRef} - V_{XOffset}$	$V_{XDif} - V_{XRef}$
ΔY	$V_{YRef} - 0$	$V_{YDif} - V_{YRef}$	$V_{YRef} - 0$	$V_{YRef} - V_{YOffset}$	$V_{YDif} - V_{YRef}$
<i>WHERE:</i>					
AAbs	Absolute Amplitude cursors		V_{XRef}	Voltage of the Reference cursor on the X trace	
ARel	Relative Amplitude cursors		V_{YRef}	Voltage of the Reference cursor on the Y trace	
TAbs	Absolute Time cursors		V_{XDif}	Voltage of the Difference cursor on the X trace	
TRel	Relative Time cursors		V_{YDif}	Voltage of the Difference cursor on the Y trace	
Org	Origin				

CUSTOM

Press  to access menus that let you customize special functions. The contents of the Custom Menu will vary according to the options installed in the oscilloscope.

LC684 SERIES ONLY

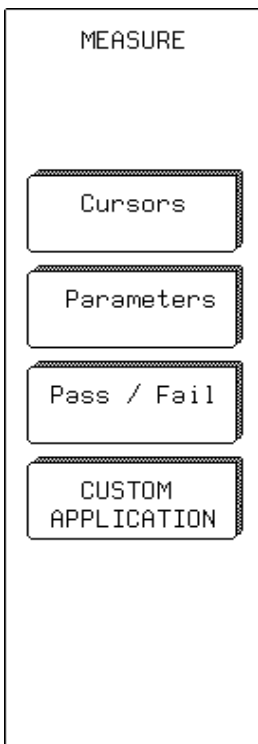

Press the CURSOR/MEASURES button; the following options will be displayed:

Cursors

Refer to “Measure – Cursors” on page 14-5 of this manual.

Parameters

Refer to “Parameters: Automatic Measurements” starting on page 14-8, and Appendix D of this manual.

Pass/Fail

Refer to “Pass/Fail Testing” on page 14-13 of this manual.

Custom Application

Refer to Custom Menu on page 14-4 of this manual.



CUSTOM (continued)

LC684 SERIES ONLY

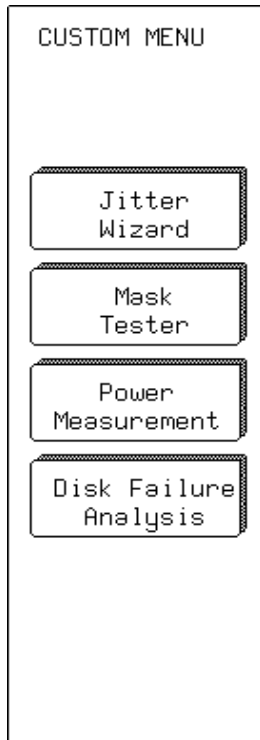

Press the CUSTOM button to access these custom applications:

Jitter Wizard

This wizard steps you through jitter timing and measurement setups. Refer to the *Jitter and Timing Analysis (JTA) Manual*.

Mask Tester

Refer to the *Mask Tester Operator's Manual*.

Power Measurement

Refer to the *PMA1 Software Operator's Manual*.

Disk Failure Analysis

Refer to the *DDFA: Disk Drive Failure Analysis Operator's Manual*.

MEASURE — Cursors

Press  to access the "MEASURE" Setup menus.

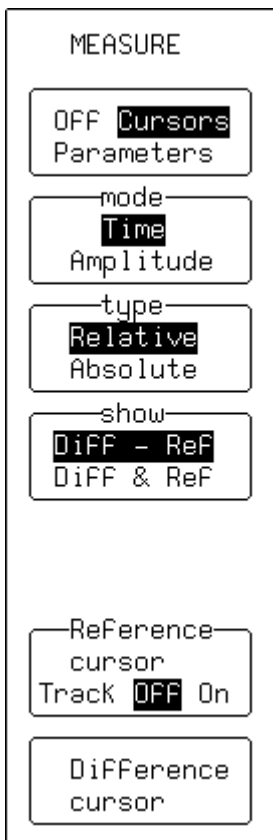

Off/Cursors/Parameters

Use this to select **Cursors**.

mode

This is for selecting **Time** (time or frequency cursors) or **Amplitude** (voltage or amplitude cursors).

type

Use this to toggle between **Relative** and **Absolute**. The first displays two cursors (Reference and Difference) and indicates either the voltage, or time and voltage, between the two. The second shows a single cursor that indicates either voltage compared to ground level, or this *and* time compared to the trigger point.

show

Use this to select **Diff – Ref**, which shows the numerical difference between Difference and Reference cursor amplitudes. Alternatively, **Diff & Ref** displays the amplitude values for each cursor. *This is not available in persistence mode.*

Reference cursor

Use this to control the Reference cursor that is available with Relative cursors, using the associated menu knob. With "Track" **ON**, both Reference and Difference cursors are controlled by the associated knob, and move together. A constant time or voltage interval is maintained between them. This tracking interval is represented by a bar — horizontal for time; vertical for voltage — appearing at the top and left-hand edge of the grid, respectively.

Difference cursor

This is for controlling the Difference cursor, available when **Relative** is selected from "type" (see above), using the associated menu knob.

Cursor position (not shown)

This is for controlling the Absolute cursor, available when **Absolute** is selected from "type" (see above), using the associated menu knob.



Parameters: Automatic Measurements

The instrument can determine certain signal properties automatically, using signal parameters. Standard parameters are listed and described in Appendix D of this manual.

For common measurements on a lone signal, parameters can be measured in either of two standard classes or modes, in the amplitude or time domain.

On different signals, they can be customized and used to determine up to five of the quantities on the parameter list. Customized parameter measurements can also be used for Pass/Fail testing against chosen limits (see page 14–15). Several other modes are available, according to the parameters and options installed in the oscilloscope (not all modes illustrated may be available).









Statistics on the parameter values are accumulated and can be displayed for all modes.

In addition to the overall number of sweeps used, each parameter has its average, lowest, and highest value. The standard deviation of the parameter is also calculated.

Parameter Symbols

The algorithms that determine pulse waveform parameters are able to detect those situations where the mathematical formulas may be applied. However, the results obtained should be interpreted with caution. In such cases the scope displays the name of the parameter and its value, which are separated by a graphic symbol. The symbol provides information about the parameter, or issues a warning. The following table explains these symbols.

* A wide range of additional parameters is available in the specialized software packages, such as WP03, described in the *Operator's Manuals* for those packages.

Information	
	The parameter has been determined for several periods (up to 100), and the average of those values has been taken.
	The parameter has been determined over an integral number of periods.
	The parameter has been calculated on a histogram.
	Insufficient data to determine the parameter.
Warnings	
	Amplitude histogram is flat within statistical fluctuations; minimum and maximum are used to assign top and base.
	Only an upper limit could be estimated (the actual value of the parameter may be smaller than the displayed value).
	The signal is partially in overflow.
	The signal is partially in underflow.
	The signal is partially in overflow and in underflow.



CURSORS/MEASURE & Parameters

MEASURE — Parameters — Standard Voltage

For a single trace, this mode measures:

- peak-to-peak (amplitude between maximum and minimum sample values)
- mean of all sample values
- standard deviation
- root mean square of all sample values
- amplitude of the signal

```
MEASURE
OFF Cursors
Parameters
mode
Std Voltage
Std Time
Custom
List by nT
Pass
statistics
OFF On
on trace
1 2
from
0.00 div
Track OFF On
to
10.00 div
10000 pts
```

Off/Cursors/Parameters

Use this to select **Parameters**.

mode

This is for selecting the **Standard Voltage** mode.

statistics

This is for turning **On** display of the parameter's average, lowest, highest, and standard deviation, as well as the number of sweeps included in the statistics. The number of sweeps is cleared each time you change the acquisition conditions, or when you press the CLEAR SWEEPS button. As long as **Parameters** is highlighted in the top menu, the accumulation of statistics continues, even if the statistics are not shown.

on trace

Use this to select the trace for which the voltage parameters are measured. The choices available in this menu will depend on the traces displayed (a maximum of four traces can be displayed). Here traces 1 and 2 are displayed and **2** is selected.

from

Use this to determine the starting point (in screen divisions) for parameter measurements, using the associated menu knob. "Track" **On** links control of the starting and end points of the parameter measurement so that they can be moved together, using the associated menu knob.

to

Use this to determine the end point in screen divisions. It also indicates the total number of data points used for the measurements.

MEASURE — Parameters — Standard Time

For a single trace, this mode measures:

- period
- width (at 50% amplitude)
- rise time (10–90% of amplitude)
- fall time (90–10% of amplitude)
- delay (from trigger to first 50% amplitude point)

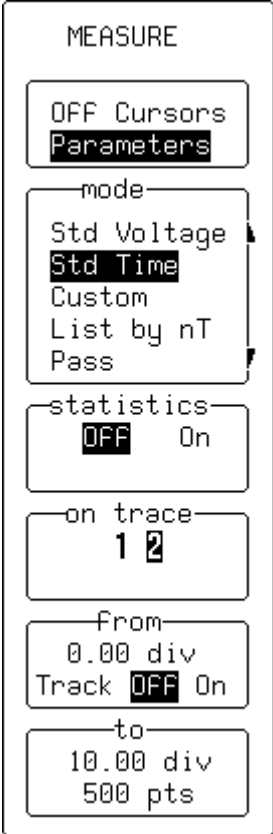

Off/Cursors/Parameters

Use this to select **Parameters**.

mode

This is for selecting the **Standard Time** mode.

statistics

This is for turning **On** display of the parameter's average, lowest, highest, and standard deviation, as well as the number of sweeps included in the statistics. The number of sweeps is cleared each time you change the acquisition, or when you press the CLEAR SWEEPS button.

As long as **Parameters** is highlighted in the top menu, the accumulation of statistics continues, even if the statistics are not shown.

on trace

This is for selecting the trace for which the time parameters are to be measured. The choices available in this menu will depend on the traces displayed (a maximum of four traces can be displayed). Here traces 1 and 2 are displayed and 2 selected.

from

Use this to determine the starting point (in screen divisions) for parameter measurements. "Track" **On** links control of both the starting and end points of the parameter measurement so that they can be moved together, using the associated menu knob.

to

Use this to determine the end point in screen divisions. It also indicates the total number of data points used for the measurements.



CURSORS/MEASURE & Parameters

MEASURE — Parameters — Custom

In this mode, up to five parameters can be displayed for various traces.

```
MEASURE
OFF Cursors
Parameters
mode
Std Voltage
Std Time
Custom
List by nT
Pass
statistics
OFF On
CHANGE
PARAMETERS
From
0.00 div
Track OFF On
to
10.00 div
```

Off/Cursors/Parameters

This is for selecting **Parameters**.

mode

This is for selecting the **Custom** mode.

statistics

This is for turning **On** display of the parameter's average, lowest, highest, and standard deviation, as well as the number of sweeps included in the statistics. The number of sweeps is cleared each time you change the acquisition conditions, or when you press the CLEAR SWEEPS button.

As long as **Parameters** is highlighted in the top menu, the accumulation of statistics continues, even if the statistics are not shown.

CHANGE PARAMETERS

This is for accessing the secondary "CHANGE PARAM" menu (see following pages).

from

Use this to determine the starting point (in screen divisions) for parameter measurements. "Track" **On** links control of the starting and end points of the parameter measurement so that they can be moved together, using the associated menu knob.

to

Use this to determine the end point in screen divisions.

CHANGE PARAM

This is for modifying parameters.

```
CHANGE PARAM
  On line
  1 2 3 4 5
  Category
  All
  DISK-Std
  DISK-Local
  DISK-PRML
  OPTICAL-Data
  DELETE ALL
  PARAMETERS
  measure
  --
  acsn
  ampl
  area
  avg
  of
  1 2 3 4
  A B C D
```

On line

Use this to select up to five different parameters for modification.

Category

Use this to specify the category of parameter. When **All** is selected, the “measure” menu (see below) will feature all parameters. However, when a particular category is selected, only those parameters in the category are shown.

DELETE ALL PARAMETERS

This is for deleting all parameters previously selected.

measure

Use this to choose the new parameter to be measured on this line. When you select “--” the line is not used.

of

This is for selecting the channel or trace on which the parameter will be measured.



CURSORS/MEASURE & Parameters

CHANGE PARAM

Parameters can be customized to meet specific needs.

```
CHANGE PARAM
-----
On line
 1 2 3 4 5
-----
Category
All
DISK-Std
DISK-Local
DISK-PRML
OPTICAL-Data
-----
MORE Δt@lv
  SETUP
-----
measure
Δp2c
Δp2cs
Δt@lv
dur
duty
-----
source
From 1
to 2
```

On line

Use this to select up to five different parameters for modification.

Category

Use this to specify the category or type of parameter.

MORE Δt@lv SETUP

This calls up the Δt@lv customization menu (see next page).

measure

Set at Δt@lv.

source

Select the channel — 1, 2 (3 or 4) — or memory (A, B, C, or D) by means of the associated menu button. Use the associated knob to decide **from** which, and **to** which, channel the measurement is to be made.

SETUP

This is for customizing the measure parameter ($\Delta t@lv$ in this case). See Appendix D for descriptions of all standard parameters.

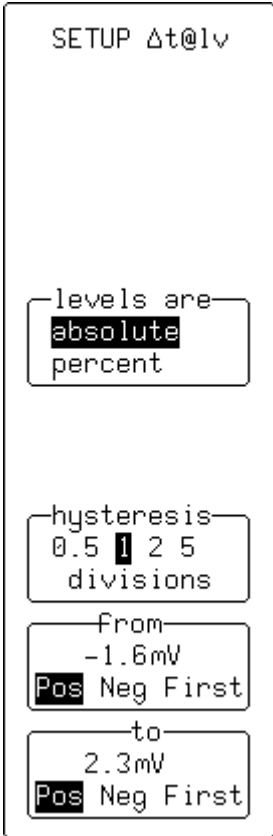

levels are

This is for selecting whether the levels should be absolute, or a percentage of the peak-to-peak signal value.

hysteresis

Use this to set the hysteresis division. A voltage band is extended equidistantly above and below the selected level. In order for the signal to be considered valid, and not as noise, the signal must exceed or cross the upper or lower limits of this band by half the hysteresis division setting.

from

This is for selecting the voltage or amplitude percentage setting of the level on the waveform at which the timing is to be measured. It is also used to select whether the measurement should be made on a **Positive** (rising) edge, or a **Negative** (falling) edge; or, if **First** is selected, on either type of edge.

to

This is for selecting the voltage or amplitude percentage setting of the level on the waveform at which the timing is to end. It is also used to select whether it should finish on a **Positive** (rising) edge or a **Negative** (falling) edge; or, if **First** is selected, on either type of edge.



CURSORS/MEASURE & Parameters

SETUP

SETUP $\Delta c2d+$

hysteresis
0.5 **1** 2 5
divisions

clock edge
1.6mV
Pos Neg All

data edge
6.2mV
Pos Neg First

This is for customizing the measure parameter ($\Delta c2d+$ in this case). See Appendix D for descriptions of all standard parameters.

hysteresis

Use this to set the hysteresis division. A voltage band is extended equidistantly above and below the selected level. In order for the signal to be considered valid, and not as noise, the signal must exceed or cross the upper or lower limits of this band by half the hysteresis division setting.

clock edge

Use this to select the clock edge or edges used for this parameter measurement.

data edge

This is for selecting the data edge or edges used for the measurement.

Pass/Fail Testing

Parameters can also be used in performing Pass/Fail tests. These tests require a combination of measurements within chosen limits, and invoke an action when the test either passes or fails, depending on which has been specified. Signals can also be Pass/Fail tested against a tolerance mask.

Up to five parameters can be tested against limits at the same time. In tolerance mask testing, a trace can be compared to a tolerance mask.

Whether the tests pass or fail, any or all of the following actions can be invoked:

- Stop capturing further signals.
- Dump the screen image to a hardcopy unit.
- Store selected traces to internal memory, to a memory card (optional), or to a floppy disk.
- Sound the buzzer.
- Emit a pulse on the CAL BNC.

The Pass/Fail display will show:

- results on the current waveforms
- the number of events passing
- the total number of sweeps treated
- actions to be taken



CURSORS/MEASURE & Parameters

MEASURE — Parameters — Pass/Fail

```
MEASURE
OFF Cursors
Parameters
mode
Std Time
Custom
List by nT
Pass
Fail
testing
OFF On
CHANGE TEST
CONDITIONS
From
0.00 div
Track OFF On
to
10.00 div
```

Off/Cursors/Parameters

Use this to select **Parameters**.

mode

Use this to select **Pass** or **Fail**.

testing

This is for turning testing **Off** or **On**. Turn testing off only to observe the parameter variations.

CHANGE TEST CONDITIONS

Use this to access the secondary "CHANGE TEST" menu (see next page).

from

Use this to determine the starting point, in screen divisions, for parameter measurements.

to

Use this to determine the end point in screen divisions.

CHANGE TEST

CHANGE TEST
On line 1 2 3 4 5 Action
Test on Param Mask ---(No Test)
choose Param Limit
DELETE ALL TESTS
measure -- acsn ampl area avg
of 1 2 3 4 A B C D

On line
Use this to select up to five different parameters for modification. (See "Action" selection on page 14–22).

Test on
Use this to select **Param** or, if no test is required, --- (**No Test**).

choose
To select "**Param**".

DELETE ALL TESTS
Use this to delete all tests previously selected.

measure
This is for selecting the new parameter to be measured on this line. When "--" is selected the line is not used.

of
This is for selecting the channel or trace on which the parameter will be measured.



CURSORS/MEASURE & Parameters

CHANGE TEST — Param (Changing Limits for Pass/Fail Tests on Parameters)

CHANGE TEST
On line 1 2 3 4 5 Action
Test on Param Mask ---(No Test)
choose Param Limit
DELETE ALL TESTS
True if < >
limit +0.00 E+00 3 digits
SET TO LATEST VALUE

On line

Use this to select up to five different parameters for modification. (See "Action" selection on page 14–22).

Test on

Use this to Select **Param** or **---** (**No Test**) if no test is required on the selected line ("Mask" selection, page 14–19).

choose

Use this to select **Limit** ("Param" 14–17).

DELETE ALL TESTS

This is for deleting all tests previously selected.

True if

This is for selecting the appropriate relation: less than or greater than.

limit

Use this to choose one of three modifications to a limit: its mantissa, exponent, or the number of digits in its mantissa. The corresponding menu button is used to select, and the associated knob to modify, the number in that field.

SET TO LATEST VALUE

Use this to set a limit to the latest measured value — a starting value for the final adjustment.

CHANGE TEST — Mask (Changing Pass/Fail Test on a Mask)

CHANGE TEST

On line
1 2 3 4 5
Action

Test on
Param Mask
---(No Test)

MODIFY MASK

True if
all points
some points

of
1 2 3 4
A B C D

are
inside
outside

mask
A B C D

On line

Use this to select up to five different parameters for modification. (See "Action" selection on page 14–22).

Test on

This is for selecting **Mask** or **---** (**No Test**) if no test is required on the selected line (see "Param" on page 14–17).

MODIFY MASK

Use this to access the secondary menu for modifying mask settings.

True if

This is for choosing the mask test condition.

of

Use this to select channel or trace for testing.

are

This is for choosing the mask test condition.

mask

Use this to select a mask trace.

Note: Pass/Fail testing on a mask is affected by horizontal and vertical zooming of the mask trace. The test will be made inside the area bordered by the parameter cursors. Timebases of the mask and the trace under test should be identical. For visual mask testing, a single grid should be used when you are performing a mask test on a single trace. A two-grid display should be used for testing on two traces.



CURSORS/MEASURE & Parameters

MODIFY MASK — W'form (Generating a Mask from a Waveform)

MODIFY MASK
From W'Form HDD Card Flpy
into D=M4 M1 M2 M3 M4
INVERT MASK D=M4
Use W'Form 1 2 3 4 A B C D M1 M2 M3 M4
MAKE MASK D=M4
delta V 0.50 div
delta T 0.20 div

from

Use this to select **W'form**.

into

This is for selecting **D=M4** if the mask is to be automatically displayed on the screen. Otherwise select **M1**, **M2**, **M3**, or **M4**.

Using "RECALL W'FORM" (see previous chapter), memories M1–M4 can be recalled to traces A to D for display.

INVERT MASK

Use this to generate an inverted mask.

Use W'form

This is for selecting the waveform to be used as reference. The mask will be generated around this waveform.

MAKE MASK

Use this to generate the mask.

delta V

This is for selecting tolerance in amplitude, by means of the associated knob.

delta T

This is for selecting tolerance in time, by means of the associated knob.

MODIFY MASK

FLOPPY DISK OR OPTIONAL STORAGE DEVICE



from

Use this to select the device.

into

This is for selecting **D=M4** to automatically display the mask on-screen, or **M1**, **M2**, **M3**, or **M4**.

INVERT MASK

This is for generating an inverted mask.

DO RECALL

Use this to recall the mask.

File

Use this to select the appropriate mask, by means of the associated knob.



CURSORS/MEASURE & Parameters

CHANGE TEST — Action (Setting PASS/FAIL Actions)

```
CHANGE TEST
  On line
  1 2 3 4 5
  Action

DELETE ALL
ACTIONS

  IF
  Pass Fail

  Then:
  Stop No
  Store No
  Dump Yes
  Beep No
  Pulse No

  Dump
  No Yes
```

Depending on the test result certain actions can be taken:

On line

This is for selecting Action.

DELETE ALL ACTIONS

Use this to delete all previously selected actions.

If

Use this to determine if the action will be taken on **PASS** or **FAIL** result.

Then

This is for selecting the action (**Dump** in this example). The selected action will then be activated from the following submenu.

Dump

Use this to perform (**Yes**) or disable (**No**) the action chosen in the "Then" menu (see above). The choice will be echoed alongside the already selected action in the "Then" menu.

#

Saving and Recalling Panel Setups

PANEL SETUPS

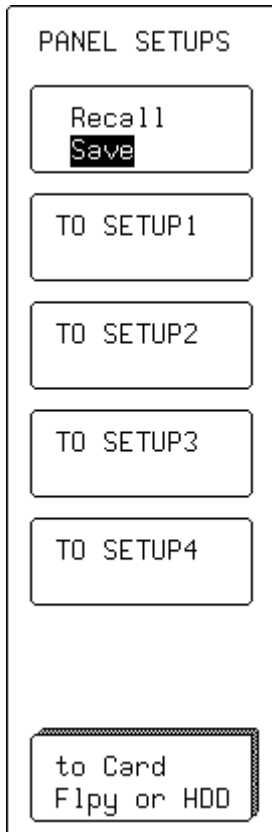

PANEL
SETUPS

Press  to access the menus used for saving or recalling configurations — panel setups — to or from non-volatile memory, floppy disk, memory card, or portable hard disk (HDD), depending on options installed.

Recall Save

Use this to save a panel setup or recall one already saved. When you select **Save** (as shown here) the “TO SETUP” menus appear. When you select **Recall**, the “FROM SETUP” menus appear

TO SETUP 1 ...2 ...3 or ...4

This is for saving any of four possible setups.

to Card, Flpy or HDD

This is for saving a setup to floppy, memory card, or hard disk (HDD), depending on options.

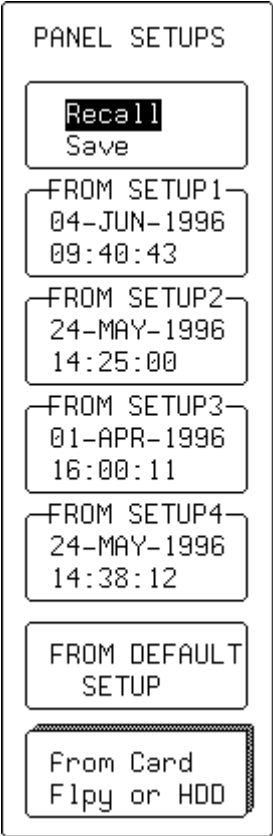

Recall/Save

Use this to save or recall a panel setup. When you select **Save** (as shown on the previous page) the "TO SETUP" menus appear. When you select **Recall** (as shown here) the "FROM SETUP" menus appear.

FROM SETUP 1 ...2 ...3 or ...4

This is for recalling any of four possible saved setups. In the example shown here, all four possible setups have been stored. When no setup has been stored, that menu will indicate "Empty."

FROM DEFAULT SETUP

Use this to choose a default setup stored in the scope.

from Card, Flpy or HDD

This is for accessing the secondary "RECALL SETUPS" menu to recall a setup stored on floppy, memory card, or portable hard disk (HDD), depending on the options installed.

RECALL SETUPS

```
RECALL SETUPS
  From
  Card  Flpy
  HDD
  Directory:
  LECROY-1.DIR
  10-OCT-96
  09:52:12
  Size 3403
  DO RECALL
  ONE.PNL
  File
  ONE  PNL
  ZERO PNL
```

from

This is for selecting the device from which to recall a setup: floppy, memory card, or portable hard disk (HDD), depending on the options installed.

DO RECALL

Use this to perform the recall of the setup selected in the "File" menu (see below).

File

This is for selecting the stored setup, using the associated menu knob.

#



BLANK PAGE

The Complete Picture, Summarized

SHOW
STATUS

Press  to open the “STATUS” menu and access full-screen summaries of the oscilloscope’s system status or other functional status.

Acquisition Status

This screen shows vertical sensitivity, probe attenuation, offset, and coupling for each channel, as well as timebase and trigger status summaries.

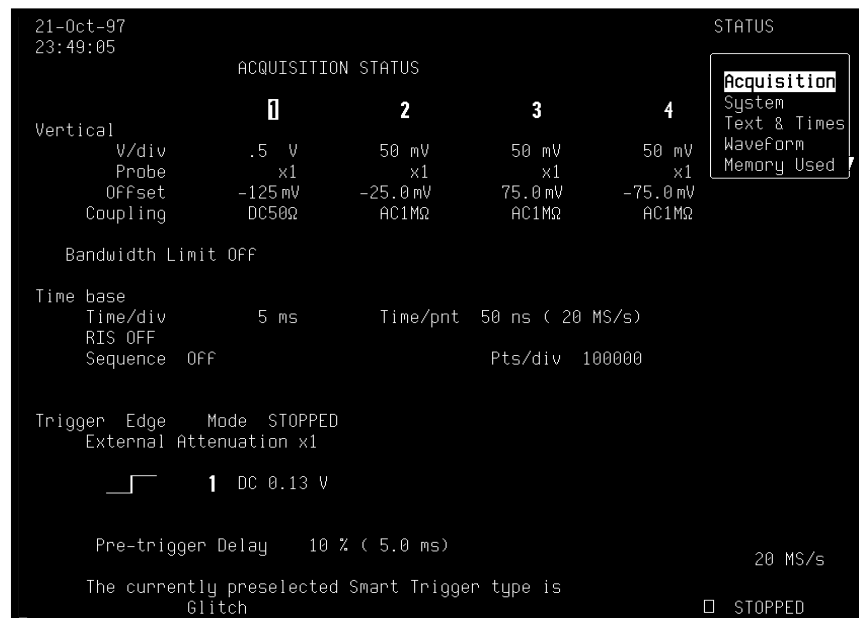



SHOW STATUS

System

This screen shows the serial number of the scope, firmware version, and the software and hardware options installed.

The “Software Options” menu accesses the “ADD OPTION KEY” menu, which lets you activate new software by inputting a code. You simply provide LeCroy with the serial number, soft version number, and scope ID (all displayed on this screen), as well as order information. LeCroy provides a unique option key that you can enter from the instrument’s front panel.

The “MORE VERSION INFORMATION” menu is used to perform a cyclic redundancy check (CRC) of the internal firmware, and generates a checksum that can be used to ensure that the firmware is uncorrupted.

```
20-May-98          STATUS
15:22:32

Serial Number LC53401024
Acquisition
System
Text & Times
WaveForm
Memory Used

Soft Version LC534AL 07.9.0
Wednesday, May 20, 1998 12:11 PM
(build 16)
Software Options
WP01 WP02 WP03 ODM CK10 PRML ORM MC01
Software Options

Hard Options
CPUP VGAC GPIB R232 CLBZ FD01 GP01 CENT
HD01 I2C
MORE VERSION INFORMATION

Main Processor RAM size: 16M bytes
Acquisition Memory size: 2M data points per channel

500 MS/s
□ AUTO
```

For information on Software Options contact your local LeCroy Sales/Service organization or visit our web-site at <http://www.lecroy.com/options>

Text & Times

This shows user text in the waveform descriptor* and trigger timing information. When "Text & Times" is selected the "for" and "Select" menus shown here also appear, allowing a trace or memory to be selected and a segment range to be specified for information.

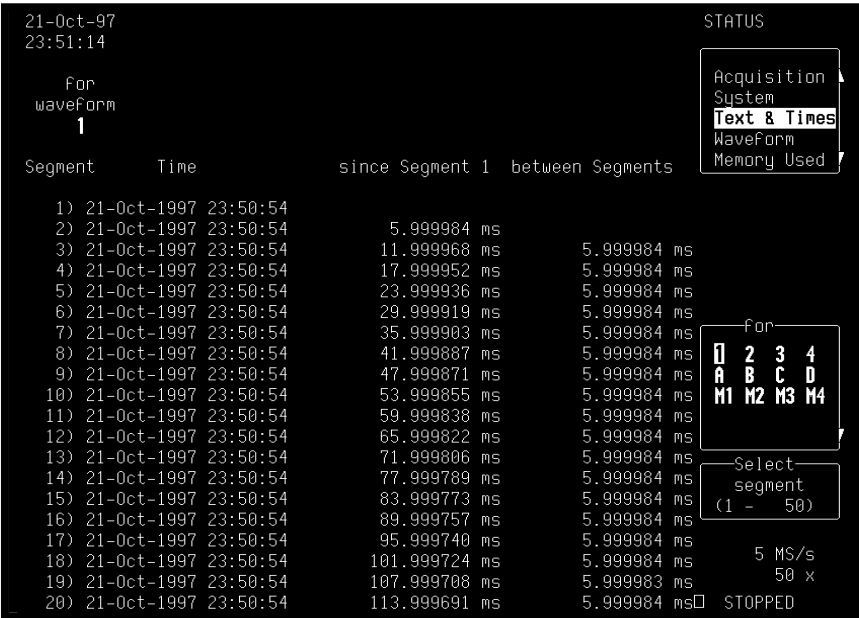

* Refer to the *Remote Control Manual*.



SHOW STATUS

Waveform Summary

This screen provides detailed status information on channels, memories, zoom and math, or displayed traces. These are specified using the bottom menu, which appears when "Waveform" is selected from the top menu.

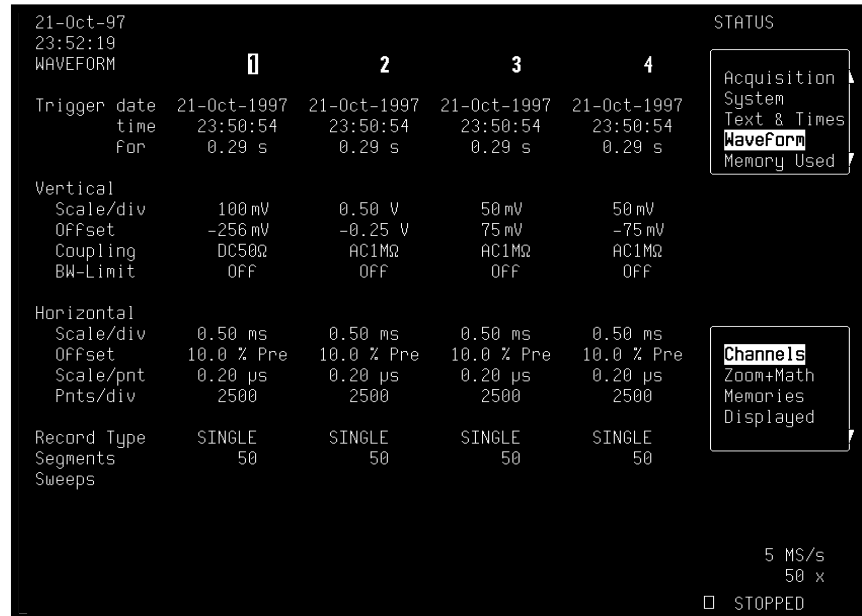

Memory Used

This screen shows how much memory is being used and how much remains free. Memory allocation: memories M1–M4 can be selected and then cleared using the “CLEAR INACTIVE” menu. The dedicated persistence data maps for each channel are dynamically created, resized, and deleted as necessary. The allocation of memory to each of these data maps will appear in this menu. Persistence data maps are cleared using the CLEAR SWEEPS button.

```
21-Oct-97
23:53:31

Memory used for storage of records

name          bytes
A             568 inactive
B             50 048 inactive
M1           2 500 892
M4             50 108
Free          9 920 824
Total        12 522 440

To free some memory, you can
. clear Memory waveforms
. reduce the number of points used for Math (MATH SETUP)
. reduce the number of samples in the Record (TIMEBASE SETUP)
. turn off traces or parameters

STATUS
Acquisition
System
Text & Times
WaveForm
Memory Used
CLEAR M1
M2 empty
M3 empty
CLEAR M4
CLEAR INACTIVE
5 MS/s
STOPPED
```

#



SHOW STATUS

BLANK PAGE

Signal Capture

Acquisition System

Bandwidth (-3 dB)

- **LC334, LC374 Series:** @ 50 Ω : DC to 500 MHz @ 1 M Ω DC: DC to 500 MHz typical at probe tip
- **LC534, LC574 Series:** @ 50 Ω : DC to 1 GHz @ 1 M Ω DC: DC to 500 MHz typical at probe tip
- **LC564, LC584 Series:** @ 50 Ω : DC to 1 GHz (2 mV/div: DC to 200 MHz, 5 mV/div: DC to 600 MHz); @ 1 M Ω DC: DC to 500 MHz typical at probe tip
- **LC684 Series:** @ 50 Ω : DC to 1.5 GHz (2 mV/div: DC to 200 MHz, 5 mV/div: DC to 600 MHz); @ 1 M Ω DC: DC to 500 MHz typical at probe tip

With PP005 passive probe as standard for all models; active probes optional.

Number of Channels: 4

Number of Digitizers: 4

Max. Sample Rate Window (Also see tables on the following pages.)

- **LC334, LC534 Series:** 4 ms @ 2 GS/s in single-shot mode
- **LC374 Series:** 0.25 ms @ 2 GS/s in single-shot mode
- **LC574 Series:** 2 ms @ 4 GS/s in single-shot mode
- **LC564 Series:** 62.5 μ s @ 4 GS/s
- **LC584 Series:** 2 ms @ 8 GS/s
- **LC684 Series:** 2 ms @ 8 GS/s

Sensitivity

- **LC334 Series:** 2 mV/div to 5 V/div, 50 Ω , fully variable
2 mV/div to 5 V/div, 1 M Ω , fully variable
- **LC374, LC534, LC574, LC564, LC584 Series:** 2 mV/div to 1 V/div, 50 Ω , fully variable
2 mV/div to 10 V/div, 1 M Ω , fully variable
- **LC684 Series:** 2 mV/div to 1 V/div, 50 Ω , fully variable
2 mV/div to 2 V/div, 1 M Ω , fully variable

Note: Where a particular series is NOT mentioned, the specification applies to all LeCroy color DSOs. Where the series is mentioned without reference to a particular model, the specification applies to all models in the series.

Specifications are liable to change without notice. For the most up-to-date information, consult the latest product data sheets, available from LeCroy offices.

Offset Range

- **LC334 Series:** 2.00 to 9.99 mV/div: ± 120 mV
10.0 to 199 mV/div: ± 1.2 V
0.2 to 5.0 V/div: ± 24 V
- **LC374, LC534, LC574, LC564, LC584 Series:**
2.00 to 4.99 mV/div: ± 400 mV
5.00 to 99 mV/div: ± 1 V
0.1 to 0.99 V/div: ± 10 V
1.0 to 10 V/div: ± 100 V (1 M Ω only)
- **LC684 Series:** 2.00 to 4.99 mV/div: ± 400 mV
5.0 to 99 mV/div: ± 1.0 V
0.1 to 1.0 V/div: ± 10 V
5.0 to 100 mV/div: ± 1.0 V
102 mV to 2.0 V/div (1 M Ω only): ± 20 V

LC SERIES Specifications

Maximum Sample Rate and Acquisition Memories LC334, LC374, LC534, LC574 Series					
CHANNELS USED (PEAK DETECT ON/OFF) ON SERIES...	MAX. SAMPLE RATE	MEMORY PER CHANNEL (IN POINTS)			ACTIVE CHANNELS
		MODEL			
		A	AM	AL	
Any Channel (Peak Detect OFF)					
LC334, LC534 Series	500 MS/s	100 k	500 k	2 M	All
LC374 Series	1 GS/s	100 k	–	–	
LC574 Series	1 GS/s	100 k	500 k	2 M	
Any Channel (Peak Detect ON)					
LC334, LC534 Series	100 MS/s data + 400 MS/s peaks	50 k data + 50 k peaks	250 k data + 250 k peaks	1 M data + 1 M peaks	All
LC374 Series					
LC574 Series					
Paired Channels (Peak Detect OFF)					
LC334, LC534 Series	1 GS/s	250 k	1 M	4 M	CH 2 & CH 3
LC374 Series	2 GS/s	250 k	–	–	
LC574 Series	2 GS/s	250 k	1 M	4 M	
All Channels Combined (Peak Detect OFF)					
LC334, LC534 Series (by PP093 Adapter)	2 GS/s	500 k	2 M	8 M	One
LC374 Series (<i>without</i> external adapter)	2 GS/s on CH 2	500 k	–	–	
LC574 Series (by PP093 Adapter)	4 GS/s	500 k	2 M	8 M	

Maximum Sample Rate and Acquisition Memories LC564, LC584 Series						
CHANNELS USED ON SERIES...	MAX. SAMPLE RATE	MEMORY PER CHANNEL (IN POINTS)				ACTIVE CHANNELS
		MODEL				
		A	AM	AL	AXL	
Any Channel						
LC564 Series	2 GS/s	100 k	–	–	–	All
LC584 Series	2 GS/s	100 k	500 k	2 M	4 M	
Paired Channels						
LC564 Series	4 GS/s	250 k	–	–	–	CH 2 & CH 3
LC584 Series	4 GS/s	250 k	1 M	4 M	8 M	
All Channels Combined						
LC584 Series	8 GS/s	500 k	2 M	8 M	16 M	One (CH 2, or any displayed channel in Auto-Combine Mode)

LC SERIES Specifications

Maximum Sample Rate and Acquisition Memories LC684 Series						
CHANNELS USED	MAX. SAMPLE RATE	MEMORY PER CHANNEL (IN POINTS)				ACTIVE CHANNELS
		MODEL				
		D	DM	DL	DXL	
Any Channel						
LC684 Series	2 GS/s	100 k	500 k	2 M	4 M	All
Paired Channels						
LC684 Series	4 GS/s	250 k	1 M	4 M	8 M	CH2 & CH3
All Channels Combined						
LC684 Series (by PP096 Adapter)	8 GS/s	500 k	2 M	8 M	16 M	One



Scale Factors: There is a wide range of probe attenuation factors available.

DC Accuracy: $\pm 1\%$ typical; guaranteed $\leq \pm 2\%$ full scale (eight divisions) at 0 V offset

- **LC564, LC584 Series:** $\pm(1\% \text{ full scale} + 1\% \text{ offset value})$ at gain ≥ 10 mV/div
- **LC684 Series:** $\pm(2\% \text{ full scale} + 1\% \text{ offset value})$ at gain ≥ 10 mV/div

Vertical Resolution: 8 bits

Bandwidth Limiter

- **LC334 Series:** 30 MHz
- **LC374, LC534, LC574 Series:** 25 MHz, 200 MHz
- **LC564, LC584, LC684 Series:** 25 MHz and 200 MHz typical

Input Coupling: AC, DC, GND

Input Impedance:

- **LC334 Series:** $10 \text{ M}\Omega//15 \text{ pF}$ (system capacitance using PP005)
- **LC374, LC534, LC574, LC564, LC584 Series:** $10 \text{ M}\Omega//11 \text{ pF}$ (system capacitance using PP005), or $50 \text{ }\Omega \pm 1\%$
- **LC684 Series:** $10 \text{ M}\Omega//11 \text{ pF}$ (system capacitance using PP005), or $50 \text{ }\Omega \pm 1.25\%$

Max. Input: $50 \text{ }\Omega$: $\pm 5 \text{ V DC}$ (500 mW) or 5 V rms

- **LC334:** $1 \text{ M}\Omega$ — 250 V max (DC + peak AC ≤ 10 kHz)
- **LC374, LC534, LC574, LC564, LC584 Series:** $1 \text{ M}\Omega$: 400 V max. (DC + peak AC ≤ 10 kHz)
- **LC684 Series:** $1 \text{ M}\Omega$: 100 V (DC + peak AC @ 10 kHz)

SMARTMemory: The total memory management system dynamically manages acquisition memory to guarantee that signals are always sampled at the highest possible sample rate and that system RAM and microprocessor resources are always optimally employed.



LC SERIES Specifications

System Random Access Memory:

Models					System RAM (Mbytes)
LC334A	LC374A	LC534A	LC574A		8
LC334AM	LC534AM	LC564A	LC574AM		
LC334AL	LC534AL	LC564A	LC584A	LC584AM	16
LC684D		LC684DM			16
LC574AL	LC584AL		LC584AXL		64
LC684DL		LC684DXL			64

Acquisition Modes

Random Interleaved Sampling (RIS): for repetitive signals from:

- **LC334, LC534 Series:** 1 ns/div to 5 μ s/div
- **LC374, LC574 Series:** 1 ns/div to 2 μ s/div
- **LC564, LC584, LC684 Series:** 200 ps/div to 1 μ s/div

Single Shot: for transient and repetitive signals from:

- **LC334, LC534 Series:** 10 ns/div
- **LC374, LC574 Series:** 1 ns/div, all channels active
- **LC564, LC584, LC684 Series:** 2 ns/div, all channels active

Peak Detect (NOT ON LC564, LC584, OR LC684 SERIES): At 400 MS/s, peak detect can capture high-speed events as low as 1 ns, while simultaneously capturing normally sampled data. (However, with a resolution of 2.5 ns there is no guarantee that all high-speed events less than 2.5 ns in duration will be captured with Peak Detect.)

Sequence: This stores multiple time-stamped events in segmented acquisition memories.

Dead Time between Segments: 30 μ s typical, 65 μ s max. (or < 30 μ s, 50 μ s max. on **LC334, LC534, LC574, AND LC684 SERIES**)



Number of Segments Available:

Models					No. Segments
LC334A	LC374A	LC534A	LC574A		2 to 500
LC564A		LC584A	LC684D		2 to 1000
LC334AM, AL	LC534AM, AL	LC574AM, AL	LC584AM	LC684DM	2 to 2000
LC584AL, AXL		LC684DL	LC684DXL		2 to 6000

Timebase System

Timebases: main and up to four Zoom Traces

Time/Div Range: 1 ns/div to 1000 s/div

- **LC564 Series:** 1 ns/div at 4 GS/s, and 2 ns/div at 2 GS/s, to 1000 s/div
- **LC584, LC684 Series:** 500 ps/div at 8 GS/s

Clock Accuracy: ≤10 ppm

- **LC684 Series:** <10 ppm

Interpolator Resolution: 10 ps

- **LC684 Series:** 5 ps

Roll Mode:

- **LC334, LC374, LC534, LC574 Series:** for >500 000 points: 10 to 1000 s/div
- **LC564, LC584, LC684 Series:** ranges from 500 ms/div to 1000 s/div

External Clock:

- **LC334, LC374, LC534, LC574 Series:** ≤100 MHz (20 to 100 MHz for **LC374 AND LC574 SERIES**) on EXT input with ECL, TTL, or zero crossing levels. Optional (CKTRIG) 50 to 500 MHz rear panel fixed-frequency clock input.
- **LC564, LC584, LC684 Series:** CKTRIG option includes rear panel fixed-frequency clock input, DC to 500 MHz (<20 ns rise/fall time)

External Reference: There is an optional (CKTRIG) 10 MHz rear panel input.

Triggering System

Modes: NORMAL, AUTO, SINGLE, and STOP.

Sources: CH1, CH2, CH3, CH4, Line, Ext, Ext/10 (Ext/5 on **LC564, LC584, AND LC684 SERIES**). Slope, Level, and Coupling are unique to each source.

Slope: Positive, Negative

➤ **LC564, LC584, LC684 Series:** Positive, Negative, Bi-Slope (Window in and out)

Coupling: AC, DC, HF, LFREJ, HFREJ

Pre-trigger Recording: 0 to 100% of full scale (adjustable in 1% increments)

Post-trigger Delay: 0 to 10 000 divisions (adjustable in 0.1-div increments)

Hold-off by Time: 10 ns to 20 s

➤ **LC564, LC584, LC684 Series:** 2 ns to 20 s

Holdoff by Events: 1 to 99 999 999

Internal Trigger Range: ± 5 screen divisions

EXT Trigger Max. Input:

➤ **LC334 Series:** 10 M Ω //15 pF (LC334A system capacitance using PP002): 250 V max. (DC + peak AC ≤ 10 kHz); 50 Ω $\pm 1\%$: ± 5 V DC (500 mW) or 5 V rms

➤ **LC374, LC534, LC574 Series:** 10 M Ω //11 pF (system capacitance using PP005): 400 V (DC + peak AC ≤ 10 kHz); 50 Ω $\pm 1\%$: ± 5 V DC (500 mW) or 5 V rms

➤ **LC564, LC584A Series:** 10 M Ω //11 pF at probe tip (PP005): 400 V (DC + peak AC ≤ 10 kHz); 50 Ω $\pm 1\%$: ± 5 V DC (500 mW) or 5 V rms

➤ **LC684 Series:** 10 M Ω //11 pF at probe tip (PP005): 100 V (DC + peak AC ≤ 10 kHz); 50 Ω $\pm 3\%$: ± 5 V DC (500 mW) or 5 V rms

EXT Trigger Range: ± 0.5 V with EXT; ± 5 V with Ext/10

➤ **LC564, LC584A Series:** ± 1.2 V on EXT; ± 6 V with Ext/5

➤ **LC684 Series:** ± 0.5 V; ± 2.5 V with EXT/5

Trigger Timing: Trigger Date and Time are listed in the "Memory Status" Menu.

Trigger Comparator: There is an optional (CKTRIG) ECL rear panel output. Alternatively, the calibrator output can provide a trigger output or a PASS/FAIL test output.





SMART Trigger Types

Pattern: The oscilloscope triggers on the logic combination of five inputs — CH 1, CH 2, CH 3, CH 4, and EXT Trigger, where each source can be defined as “High,” “Low,” or “Don’t Care.” The Trigger can be defined as the beginning or end of the specified pattern.

Signal or Pattern Width: The oscilloscope triggers on the width between two selectable limits from 2.5 ns to 20 s. Typically it triggers on glitches 1 ns wide.

➤ **LC564, LC584, LC684 Series:** The oscilloscope triggers on glitches as short as 600 ps or on pulse widths 600 ps to 20 s.

Signal or Pattern Interval: The oscilloscope triggers on the interval between two selectable limits from 10 ns to 20 s.

➤ **LC564, LC584, LC684 Series:** 2 ns to 20 s

Dropout: The oscilloscope triggers if the input signal drops out for longer than a time-out from 25 ns to 20 s.

➤ **LC564, LC584, LC684 Series:** 2 ns to 20 s

Qualified: The oscilloscope triggers on any source only if a given state (or transition) has occurred on another source. (The delay between these events can be defined as a number of events on the trigger channel or as a time interval.)

TV: This allows selection of up to 1500 lines, and odd or even fields synchronized for PAL, SECAM, NTSC, or nonstandard video.

Runt (LC564, LC584, AND LC684 SERIES ONLY): The oscilloscope triggers on positive or negative runts between two selectable limits from 600 ps to 20 s.

Slew Rate (LC564, LC584, AND LC684 SERIES ONLY): The oscilloscope triggers on rising or falling edges between 600 ps and 20 s.

Exclusion Triggering: This can be performed in Glitch, Interval, Runt, and Slew-Rate trigger modes. The oscilloscope triggers on intermittent faults by specifying the normal width, period, level, or slew of a signal. It will trigger only on aberrations that are shorter or longer than normal.

Autosetup

This automatically sets sensitivity, vertical offset, and timebase on all display channels.

Autosetup Time: 2 to 3 seconds

Vertical Find: This automatically sets sensitivity and offset for selected channel.

LC SERIES Specifications



Probes

LC334: One PP005 probe is supplied per channel: DC to 350 MHz typical at probe tip, 500 V max.

LC374, LC534, LC574A, LC564, LC584, LC684 Series: One PP005 probe is supplied per channel: DC to 500 MHz typical at probe tip, 500 V max.

Probe calibration: 1 V max. into 1 M Ω , 500 mV into 50 Ω ; frequency and amplitude can be programmed; pulse or square wave can be selected; rise and fall time: 1 ns typical.





Signal Viewing

Display

Screen Type: Color 10-inch Raster Scan CRT, 0.26 mm dot pitch.

➤ **LC684 Series:** 10.4" TFT-LCD

Resolution: 640 x 480 points

Display Area: 170 mm x 125 mm

➤ **LC684 Series:** 212 mm X 160 mm

Controls: There are rear panel presets for position, brightness, and contrast; and front panel menu controls for brightness and color selection.

Grid Styles: Single, Dual, Quad, Octal, XY, Single + XY, Dual + XY, and Full Screen (enlarged view of each grid style)

Graticules: Internally generated, they have a separate intensity control for grids and waveforms, and offer selectable blending of grid with displayed traces.

Waveform Style: Choose from Dot Join with optional sample point highlight, or Dots only.

Persistence Modes: Color Graded and Analog Persistence; infinite or variable with decay over time

➤ **LC334A Series:** Analog Persistence is available only when all four channels are combined.

Trace Display: Choose from opaque or transparent modes, with overlap management.

Number of Traces: 8 (any mix of channels, memories, or Math functions)

Real-time Clock: Date, hours, minutes, seconds

External Monitor: A rear panel 15-pin socket is available for VGA compatible monitor.

Vertical Zoom: up to five times vertical expansion (50 times with averaging, up to 40 $\mu\text{V}/\text{div}$ sensitivity)

Horizontal Zoom:

➤ **LC334A, LC534A:** up to 2 or 2.5 points/division

➤ **LC374A, LC574A:** up to 0.4 or 0.5 points/division

➤ **LC564, LC584, LC684 Series:** up to 0.4 points/division

Signal Analysis

Processing System

Microprocessor: 96 MHz PowerPC™ 603e

➤ **LC584AXL, LC684DXL:** 192 MHz PowerPC™

Video Memory: 1 Mbyte

Cache Memory: 32 kbytes

Persistence Data Map Memory: 16 bits per displayed pixel (64 000 levels)

Waveform Processing

Up to four processing functions may be performed simultaneously. Standard functions available are: Add, Subtract, Multiply, Divide, Negate, Identity, Summation Averaging and Sine x/x, Integral, Derivative, Square Root, Ratio, and Absolute Value. The source information for a math function trace can be data from an acquisition channel or from another math function trace. This allows display of traces that 'daisy chain' math functions.

Average: up to 10^6 averages

Extrema: Roof, Floor, or Envelope values from 1 to 10^6 sweeps

ERES: Six low-pass digital filters provide up to 11-bit vertical resolution. Sampled data is always available, even when a trace is turned off.

FFT: Spectrum Analysis with five windowing functions and FFT averaging

Resample: This deskew feature allows a signal to be resampled and adjusted in time relative to another signal.

Statistical Diagnostics: The Parameter Analysis package permits in-depth diagnostics on waveform parameters. With this package, live histogramming of any waveform parameter measurement is possible. The histogram can be autoscaled to display the center and width of the distribution. Any of the above processes can be invoked without losing the data. Trending is also available with this package, which is standard on the LC574, LC584, and LC684 Series, and optional on all other models.



Internal Memory

Waveform Memory: This features up to four 16-bit memories (M1, M2, M3, M4), whose length corresponds to the length of the channel acquisition memory.

Zoom and Math Memory: Up to four 16-bit Waveform Processing Memories (A, B, C, D), whose length corresponds to the length of the channel acquisition memory

Setup Memory: Four non-volatile memories (optional memory cards, flash disks, or removable hard disks may also be used for high-capacity waveform and setup storage.)

Cursor Measurements

Relative Time: A pair of arrow cursors measures time differences and voltage differences relative to each other.

Relative Voltage: A pair of line cursors measures voltage differences.

Absolute Time: A cross-hairs marker measures time relative to the trigger and voltage (with respect to ground).

Absolute Voltage: A reference bar measures voltage with respect to ground.

Automatic Measurements

A wide range of pulse parameter measurements is available, categorized for ease of use. The categories include Pulse, Horizontal, and Vertical parameters. Basic statistical measurements such as average, highest, lowest, and standard deviation (included as standard) can be made on these parameter measurements in order to understand their distribution.

Pass/Fail Testing and Waveform Limit testing (using masks) can be performed. Test conditions can be expressed as either waveform parameter limits, waveform shape limits (mask), or a combination of both. Any failure can cause preprogrammed actions such as Hardcopy, Save, GPIB service request, logic pulse out, audible beep, or a combination of these.

LC SERIES Specifications

Interfacing

Remote Control: GPIB and RS-232-C for all front panel controls; internal functions

RS-232-C Port: Asynchronous; up to 115.2 kBaud for computer or terminal control, printer or plotter connection

GPIB Port: (IEEE-488.1) configurable as talker/listener for computer control and fast data transfer; command language compliant with IEEE-488.2

Centronics Port: hardcopy interface

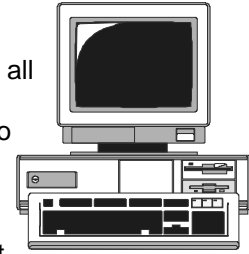

Shielded cables less than 3 m in length are required to conform to EMC Directive 89/336/EEC.

PC Card (PCMCIA I/II/III Ports): optional for memory cards, flash cards, or removable hard disks

Floppy Disk: high density 3.5-inch floppy disk drive (DOS format)

VGA Compatible Display: 15-pin, D-type, VGA-compatible connector for external color display. You may experience flickering if you connect an LCD projector to the VGA output.

Hardcopy: TIFF and BMP formats available for export to Desktop Publishing programs; HPGL protocol for vector graphics

Printers and Plotters:

- **B/W Printers:** HP LaserJet™, HP DeskJet™ 500, Epson™ FX
- **Color Printers:** HP DeskJet™ 550C; Epson™ Stylus; Canon 200, 600, 800 Series
- **Plotters:** HP 7470, HP 7550
- **Internal:** high-resolution graphics printer — standard or optional depending on model; stripchart output format with 2 m per division also available

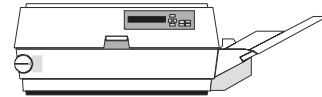

Output Formats: Binary, or ASCII waveform output compatible with spreadsheets, MATLAB™, and MathCad™

General

Auto-calibration: Ensures specified DC and timing accuracy

Temperature (operating): 5 to 40 °C (41 to 104 °F)

Humidity (operating): ≤80% RH (non-condensing)

Altitude (operating): ≤2000 m (6560 ft) at 40 °C ambient

Shock and Vibration: Conforms to selected sections of MIL-PRF-28800F, Class 3



Power: 90 to 132 VAC, or 180 to 250 VAC, 45 to 66 Hz, automatic voltage selection, 400 W max. (**LC684 Series:** 350 W max.)

Battery Backup: front panel settings maintained for two years

Dimensions: (HWD) 10.4 x 15.65 x 17.85 inches (264 x 397 x 453 mm)

Weight: 44 lb. (20 kg) net; 61.6 lb (28 kg) shipping

➤ **LC684 Series:** 35 lb (16 kg) net, 53 lb (24 kg) shipping

Warranty: 3 years

Conformity

CE Declaration of Conformity: The oscilloscope meets requirements of EMC Directive 89/336/EEC for Electromagnetic Compatibility, and Low Voltage Directive 73/23/EEC for Product Safety.

➤ **EMC:** EN 50081-1:1992 (Emissions); EN 50082-1:1997 (Immunity)

➤ **Low Voltage Directive:** Conforms to EN 61010-1:1993 + Amd. 2:1995, Safety requirements for electrical equipment for measurement, control, and laboratory use.

The oscilloscope has been qualified to the following EN 61010-1 category:

Installation (Overvoltage) Category II

Pollution Degree 2

See Declaration of Conformity for further details.

➤ **UL and cUL Certifications:** UL Standard UL 3111-1; Canadian Standard CSA-C22.2 No. 1010.1-92

UL and cUL Listing File: E 170588

#

Enhanced Resolution Filtering

The available sampling rate of LeCroy oscilloscopes is often higher than that required for the analyzed signal's bandwidth. Oversampling, particularly pronounced in the long-memory models, can be used to increase the displayed trace's effective resolution: the ability of the instrument to distinguish closely spaced voltage levels. This is done by filtering the digitized signal using Enhanced Resolution.

Although similar to signal smoothing using a simple moving-average filter, enhanced resolution filtering is more efficient both in terms of bandwidth and the superior passband characteristics that result. And on waveforms with single-shot characteristics, it can be used instead of successive trace averaging.

Advantages

Enhanced resolution filtering improves two important characteristics of the oscilloscope.

Resolution is improved by a fixed amount for each filter. This true increase in resolution occurs whether or not the signal is noisy, or whether a single-shot or repetitive signal.

Signal-to-noise ratio (SNR) is improved in such a way as to be dependent on the form of the noise in the original signal. This is because the enhanced resolution filtering decreases the bandwidth of the signal, therefore filtering out some of the noise.

Implementation

The oscilloscope's set of constant-phase, FIR (Finite Impulse-Response) filters provide fast computation, excellent step response in 0.5 bit steps, and minimum bandwidth reduction for resolution improvements of between 0.5 and 3 bits. Each step corresponds to a bandwidth reduction of a factor of two, allowing easy control of the bandwidth/resolution trade-off. The parameters of the six filters are given in the following table:



FIR Enhanced-Resolution-Filter Parameters		
Resolution Increase (Enhancement)	-3 dB Bandwidth (× Nyquist)	Filter Length (Samples)
0.5	0.5	2
1.0	0.241	5
1.5	0.121	10
2.0	0.058	24
2.5	0.029	51
3.0	0.016	117

With low-pass filters, the actual SNR increase obtained in any particular situation depends on the power spectral density of the noise on the signal. The improvement in SNR corresponds to the improvement in resolution if the noise in the signal is white — that is, if it is evenly distributed across the frequency spectrum. If the noise power is biased towards high frequencies, the SNR improvement will be better than the resolution improvement. Whereas the opposite may be true if the noise is mostly at lower frequencies.

SNR improvement due to the removal of coherent noise signals — feed-through of clock signals, for example — is decided by the fall of the dominant frequency components of the signal in the passband. This is easily ascertained using Spectral Analysis.

The filters have a precisely constant zero phase response. This has two desirable properties. First, the filters do not distort the relative position of different events in the waveform, even if the events' frequency content is different. And second, because the waveforms are stored, the delay normally associated with filtering (between the input and output waveforms) can be exactly compensated during the computation of the filtered waveform.

All the filters have been given exact unity gain at low frequency. Enhanced resolution should thus not cause overflow if the source data is not overflowed. If part of the source trace were to overflow, filtering would be allowed, but the results in the vicinity of the overflowed data — the filter impulse response length —

LC SERIES Enhanced Resolution

would be incorrect. This is because in some circumstances an overflow may be a spike of only one or two samples, and the energy in this spike may not be enough to significantly affect the results. It would then not be desirable to disallow the whole trace.

When to Use It?

In general, enhanced resolution is used to replace the averaging function in situations where the data record has a single-shot or slowly repetitive nature and averaging cannot be used.

There are two particular situations in which enhanced resolution is especially useful. One is when the signal is noticeably noisy and measurements of the noise are not required. The signal can be “cleaned up” by using the enhanced resolution function. The other is when — even if the signal is not particularly noisy — high-precision measurements of the waveform are required (when using Expand with high vertical gain, for example). Enhanced resolution will then increase the resolution of the measurements.

The examples on the following pages illustrate how enhanced resolution can be used.



Examples

Low-pass Filtering

This screen shows the spectrum of a square signal before (top grid) and after (bottom grid) enhanced resolution processing. The result clearly illustrates how the filter rejects high-frequency components from the signal. The higher the bit enhancement, the lower the resulting bandwidth.

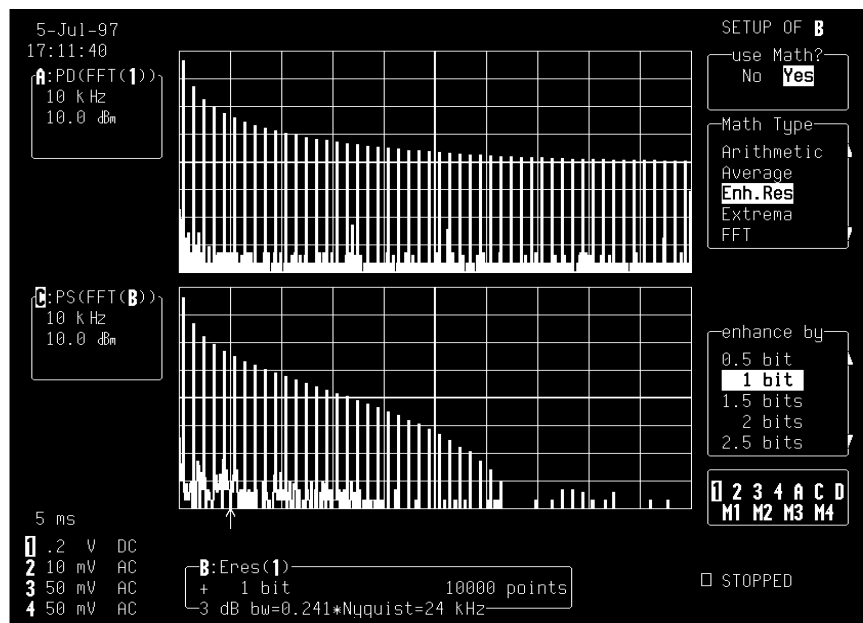

LC SERIES Enhanced Resolution

Increasing Vertical Resolution

In this example the bottom trace has been significantly enhanced by a 3-bit enhanced resolution function.

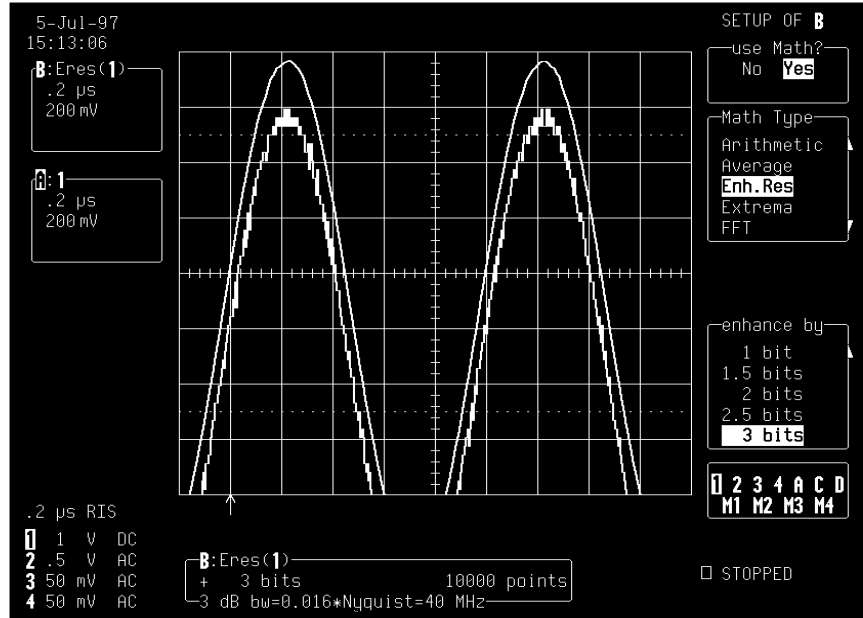

Note: The original signal being highly oversampled, the resulting bandwidth is still high enough for the signal not to be distorted.



Reducing Noise

This illustration shows the effect of enhanced resolution on a noisy signal. The original trace (top grid) has been processed by a 2-bit enhanced resolution filter. The result (bottom grid) shows a “smooth” trace, where most of the noise has been eliminated.

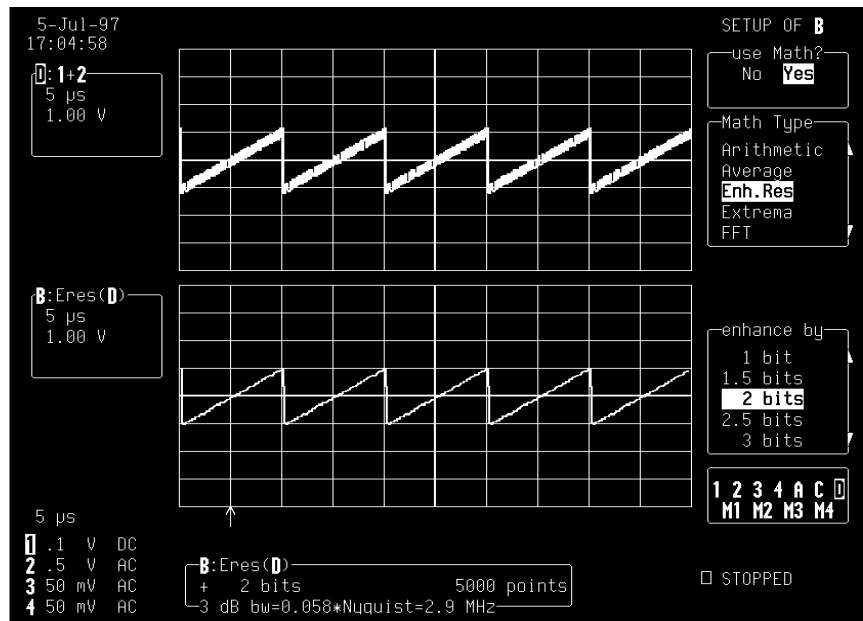

LC SERIES Enhanced Resolution

Cautionary Notes

- The enhanced resolution function can only improve the resolution of a trace; it cannot improve the accuracy or linearity of the original quantization by the 8-bit ADC.
- The constraint of good temporal response excludes the use of maximally flat filters. The pass band will therefore cause signal attenuation for signals near the cut-off frequency. The highest frequencies passed may be slightly attenuated. The frequency response of a typical enhanced resolution filter (the 2-bit enhancement filter) is illustrated below, indicating the -3 dB cut-off frequency of 5.8% of the Nyquist frequency.
- The filtering must be performed on finite record lengths: data will be lost at the start and end of the waveform, so that the trace becomes slightly shorter after filtering.
- The number of samples lost is exactly equal to the length of the impulse response of the filter used. It thus varies between two and 117 samples. Because of the oscilloscope's very long waveform memories, this loss — just 0.2% of a 50 000 point trace — is not normally noticed. However, it is possible to demand filtering on a record so short, there would be no data output. In this case the scope will not allow filtering.

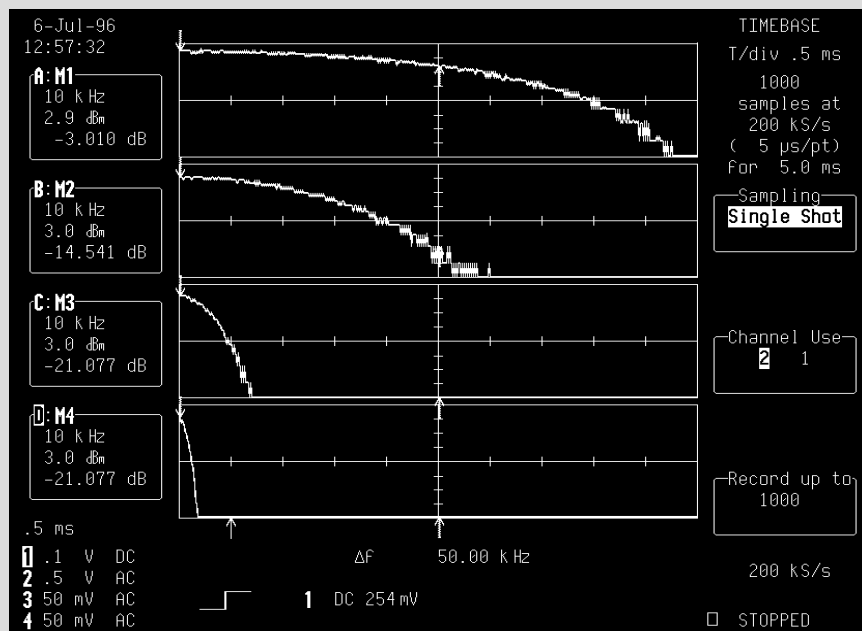

###



BLANK PAGE

When and How to Use FFT

The WP02 Spectral Analysis package with FFT (Fast Fourier Transform) reveals signal characteristics not visible in the time domain, and adds the power of frequency domain analysis to your oscilloscope. FFT converts a time domain waveform into frequency domain spectra similar to those of a spectrum analyzer, but with important differences and added benefits.

Why Use FFT?

For a large class of signals, greater insight can be gained by looking at spectral representation rather than time description. Signals encountered in the frequency response of amplifiers, oscillator phase noise and those in mechanical vibration analysis — to mention just some applications — are easier to observe in the frequency domain.

If sampling is done at a rate fast enough to faithfully approximate the original waveform (usually five times the highest frequency component in the signal), the resulting discrete data series will uniquely describe the analog signal.

This is of particular value when dealing with transient signals because, unlike FFT, conventional swept spectrum analyzers cannot handle them.

Theory Behind FFT

Spectral analysis theory assumes that the signal for transformation be of infinite duration. Since no physical signal can meet this condition, a useful assumption for reconciling theory and practice is to view the signal as consisting of an infinite series of replica of itself. These replica are multiplied by a rectangular window (the display grid) that is zero outside of the observation grid.

- ***For an explanation of FFT terms: see the Glossary on page C-17***
- ***Using FFT Functions: see page C-9***
- ***FFT Algorithms: page C-14***



Appendix C: Fast Fourier Transform (FFT)

Figure C-1 shows spectra of a swept triangular wave. Discontinuities at the edges of the wave produce leakage, an effect clearly visible in Trace A, which was computed with a rectangular window, but less pronounced in the Von Hann window in Trace B (see below for explanations of leakage and window types). Histogramming in Trace C tracks the spread of the first harmonic.

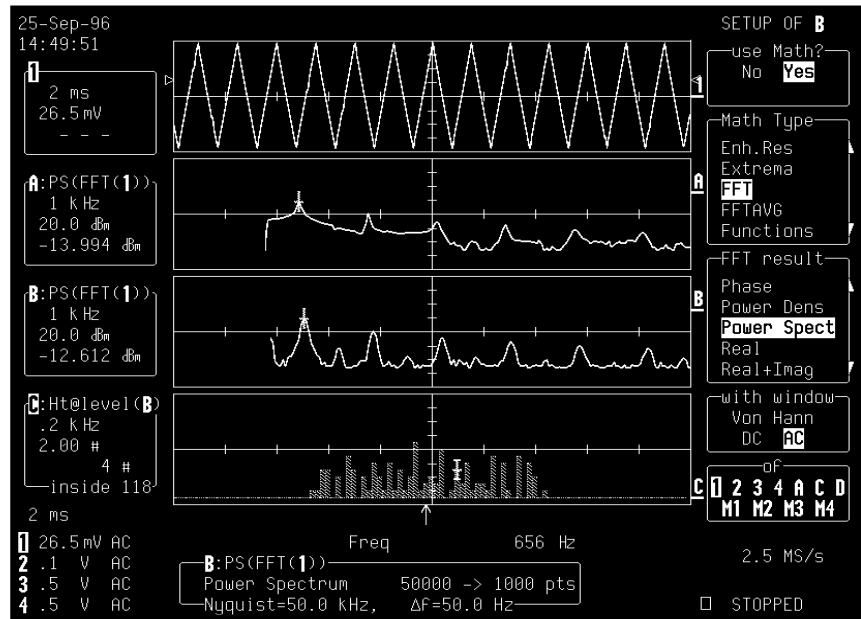

Figure C-1

Slicing the waveform in this manner is like diluting the spectral energy in an infinite number of side lobes, which correspond to multiples of the frequency resolution Δf (Fig. C-2). The observation window or capture time T determines the frequency resolution of the FFT ($\Delta f=1/T$). Whereas the sampling period and the record length set the maximum frequency span that can be obtained ($f_{Nyq}=\Delta f*N/2$).

LC SERIES Using FFT

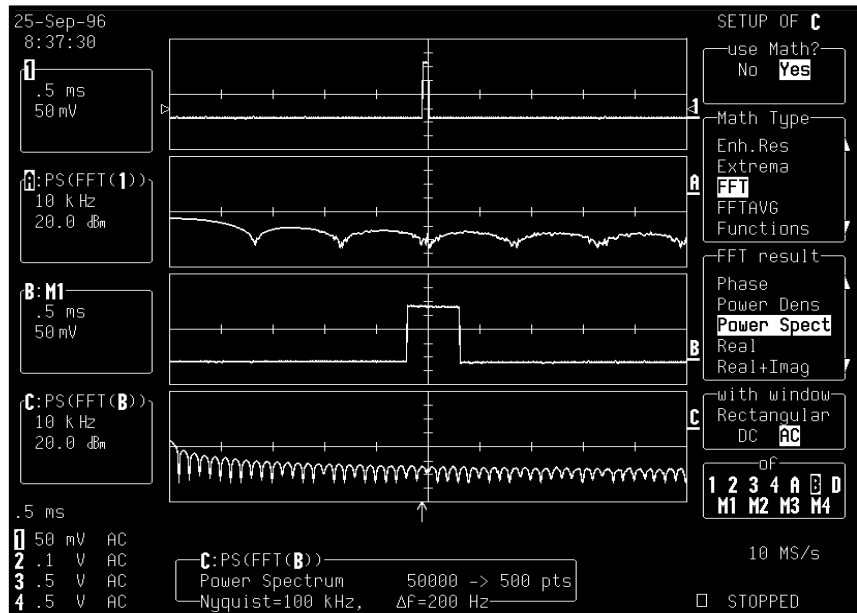

Figure C-2

An FFT operation on an N-point time domain signal may thus be compared to passing the signal through a comb filter consisting of a bank of N/2 filters. All the filters have the same shape and width and are centered at N/2 discrete frequencies. Each filter collects the signal energy that falls into the immediate neighborhood of its center frequency. Thus it can be said that there are N/2 frequency bins. The distance in Hz between the center frequencies of two neighboring bins is always the same: Δf .

Power (Density) Spectrum Because of the linear scale used to show magnitudes, lower amplitude components are often hidden by larger components. In addition to the functions offering magnitude and phase representations, the FFT option offers power density and power spectrum density functions, selected from the “FFT result” menu shown in the figures. These latter functions are even better suited for characterizing spectra. The power spectrum (V^2) is the square of the magnitude spectrum (0 dBm corresponds to voltage equivalent to 1 mW into 50 Ω .) This is the representation



Appendix C: Fast Fourier Transform (FFT)

of choice for signals containing isolated peaks — periodic signals, for instance.

The power density spectrum (V^2/Hz) is the power spectrum divided by the equivalent noise bandwidth of the filter in Hz associated with the FFT calculation. This is best employed for characterizing broadband signals such as noise.

Memory for FFT

The amount of acquisition memory available will determine the maximum range (Nyquist frequency) over which signal components can be observed. Consider the problem of determining the length of the observation window and the size of the acquisition buffer if a Nyquist rate of 500 MHz and a resolution of 10 kHz are required. To obtain a resolution of 10 kHz, the acquisition time must be at least:

$$T = 1/\Delta f = 1/10 \text{ kHz} = 100 \mu\text{s}.$$

For a digital oscilloscope with a memory of 100 kB, the highest frequency that can be analyzed is:

$$\Delta f \times N/2 = 10 \text{ kHz} \times 100 \text{ kB}/2 = 500 \text{ MHz}.$$

FFT Pitfalls to Avoid

Take care to ensure that signals are correctly acquired: improper waveform positioning within the observation window produces a distorted spectrum. The most common distortions can be traced to insufficient sampling, edge discontinuities, windowing or the “picket fence” effect.

Because the FFT acts like a bank of bandpass filters centered at multiples of the frequency resolution, components that are not exact multiples of that frequency will fall within two consecutive filters. This results in an attenuation of the true amplitude of these components.

Picket Fence and Scallop

The highest point in the spectrum can be 3.92 dB lower when the source frequency is halfway between two discrete frequencies. This variation in spectrum magnitude is the picket fence effect. The corresponding attenuation loss is referred to as scallop loss. LeCroy scopes automatically correct for the scallop effect, ensuring that the magnitude of the spectra lines correspond to their true values in the time domain.

If a signal contains a frequency component above Nyquist, the spectrum will be aliased, meaning that the frequencies will be folded back and spurious. Spotting aliased frequencies is often difficult, as the aliases may ride on top of real harmonics. A simple way of checking is to modify the sample rate and observe whether the frequency distribution changes.

Leakage

FFT assumes that the signal contained within the time grid is replicated endlessly outside the observation window. Therefore if the signal contains discontinuities at its edges, pseudo-frequencies will appear in the spectral domain, distorting the real spectrum. When the start and end phase of the signal differ, the signal frequency falls within two frequency cells broadening the spectrum.

This effect is illustrated in Figure C-1. Because the display does not contain an integral number of periods, the spectrum displayed in Trace B does not reveal sharp frequency components. Intermediate components exhibit a lower and broader peak. The broadening of the base, stretching out in many neighboring bins, is termed leakage. Cures for this are to ensure that an integral number of periods is contained within the display grid or that no discontinuities appear at the edges. Another is to use a window function to smooth the edges of the signal.

Choosing a Window

The choice of a spectral window is dictated by the signal's characteristics. Weighting functions control the filter response shape, and affect noise bandwidth as well as side lobe levels. Ideally, the main lobe should be as narrow and flat as possible to effectively discriminate all spectral components, while all side lobes should be infinitely attenuated.

Chosen from the "with window" menu, the window type defines the bandwidth and shape of the equivalent filter to be used in the FFT processing.

In the same way as one would choose a particular camera lens for taking a picture, some experimenting is generally necessary to determine which window is most suitable. However, the following general guidelines should help (see page C-11 for window types).



Appendix C: Fast Fourier Transform (FFT)

Rectangular windows provide the highest frequency resolution and are thus useful for estimating the type of harmonics present in the signal. Because the rectangular window decays as a sinc/x function in the spectral domain, slight attenuation will be induced. Alternative functions with less attenuation — Flattop and Blackman-Harris — provide maximum amplitude at the expense of frequency resolution. Whereas, Hamming and von Hann are good for general purpose use with continuous waveforms.

Improving Dynamic Range Enhanced resolution (see Appendix B) uses a low pass filtering technique that can potentially provide for three additional bits (18 dB) if the signal noise is uniformly distributed (white). Low pass filtering should be considered when high frequency components are irrelevant. A distinct advantage of this technique is that it works for both repetitive and transient signals. The SNR increase is conditioned by the cut-off frequency of the Eres low pass filter and the noise shape (frequency distribution).

LeCroy digital oscilloscopes employ FIR digital filters so that a constant phase shift is maintained. The phase information is therefore not distorted by the filtering action.

Spectral Power Averaging Even greater dynamic-range improvement is obtained on signals showing periodicity. Moreover, the range can be increased without sacrificing frequency response. The LeCroy oscilloscope being used is equipped with accumulation buffers 32 bits wide to prevent overflows.

Spectral power averaging is useful when the signal varies in time and the mean power of the signal needs to be estimated. Typical applications include noise and pseudo-random noise. Whereas time averaging ignores phase information, spectral averaging tracks magnitude as well as phase information. It is thus a superior estimator. The improvement is typically proportional to the square root of the number of averages. For instance, averaging white noise at full scale over 10 sweeps yields a typical improvement of nearly 20 dB.

LC SERIES Using FFT

Spectral power averaging is the technique to use when you are determining the frequency response of passive networks such as filters. Figures 3 and 4 show the transfer functions of a low pass filter with a 3-dB cutoff of 11 MHz, obtained by exciting the filter with a white noise source (Fig. C-3) and a sine swept generator (Fig. C-4). Both techniques give substantially the same results. The choice of method is governed by the availability of an adequate generating source.

The spectra of single time-domain waveforms can be computed and displayed to obtain power averages obtained over as many as 50 000 spectra.

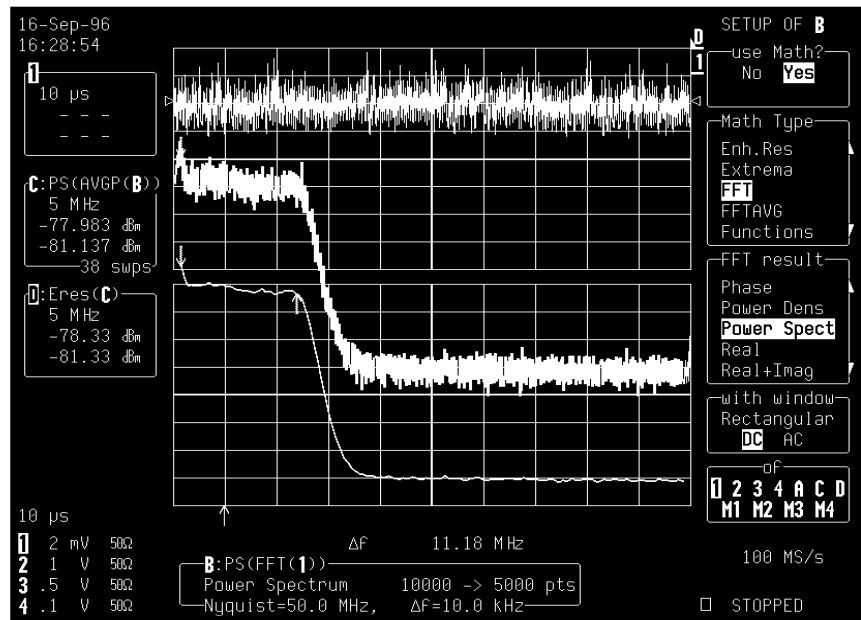

Figure C-3



Appendix C: Fast Fourier Transform (FFT)

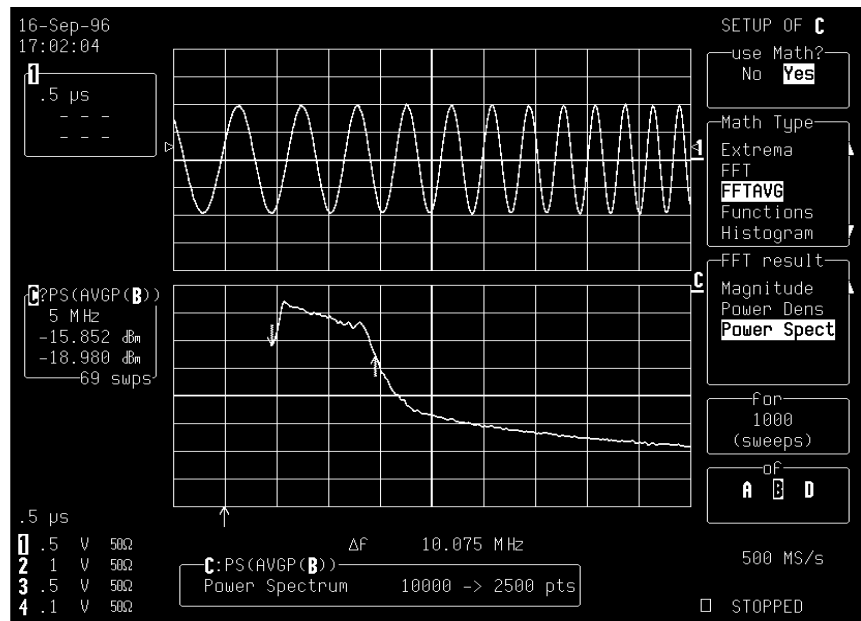

Figure C-4

Overall...

Because of its versatility, FFT analysis has become a popular analysis tool. However, some care must be taken with it. In most instances, incorrect positioning of the signal within the display grid will significantly alter the spectrum. Effects such as leakage and aliasing that distort the spectrum must be understood if meaningful conclusions are to be arrived at when using FFT.

An effective way to reduce these effects is to maximize the acquisition record length. Record length directly conditions the effective sampling rate of the scope and therefore determines the frequency resolution and span at which spectral analysis can be carried out.

Using FFT Functions

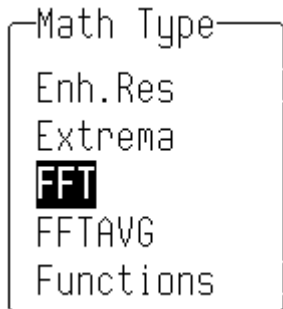

Select "FFT" from the "Math Type" menu (see Chapter 10 for a full description of math and waveform processing menus). Spectra displayed with a linear frequency axis running from zero to the Nyquist frequency are shown at the right-hand edge of the trace. The frequency scale factors (Hz/div) are in a 1–2–5 sequence.

The processing equation is displayed at the bottom of the screen, together with the three key parameters that characterize an FFT spectrum. These are:

- transform size N (number of input points)
- Nyquist frequency (= $\frac{1}{2}$ sample rate)
- frequency increment Δf between two successive points of the spectrum

These parameters are related by

$$\text{Nyquist frequency} = \Delta f * N/2$$

Where: $\Delta f = 1/T$, and where T is the duration of the input waveform record (10 * time/div). The number of output points is equal to N/2.

Note on Maximum Points: FFT spectra are computed over the entire source time-domain waveform. This limits the number of points used for FFT processing. If the input waveform contains more points than the selected maximum in "for Math use max points," they are decimated before FFT processing. But if it has fewer, all points are used.



Appendix C: Fast Fourier Transform (FFT)



The following selections can be made using the “FFT result” menu.

Phase

This is measured with respect to a cosine whose maximum occurs at the left-hand edge of the screen, at which point it has 0° . Similarly, a positive-going sine starting at the left-hand edge of the screen has a -90° phase (displayed in degrees).

Power Density

This is the signal power normalized to the bandwidth of the equivalent filter associated with the FFT calculation. The power density is suitable for characterizing broadband noise. (It is displayed on a logarithmic vertical axis calibrated in dBm.)

Power Spectrum

This is the signal power (or magnitude) represented on a logarithmic vertical scale: 0 dBm corresponds to the voltage (0.316 V peak), which is equivalent to 1 mW into 50Ω . The power spectrum is suitable for characterizing spectra that contain isolated peaks (dBm).

Magnitude

This is the peak signal amplitude represented on a linear scale. (It has the same units as the input signal.)

Real, Real + Imaginary, Imaginary

These represent the complex result of the FFT processing. (They have the same units as the input signal.)

LC SERIES Using FFT

Windows

Chosen using the “with window” menu, the window type defines the bandwidth and shape of the filter to be used in the FFT processing (see the table on page C-17 for these filters’ parameters). When “AC” is selected from the same menu, the DC component of the input signal is forced to zero prior to the FFT processing. This improves the amplitude resolution, especially when the input has a large DC component.

Window Type	Applications and Limitations
Rectangular	These are normally used when the signal is transient (completely contained in the time-domain window) or known to have a fundamental frequency component that is an integer multiple of the fundamental frequency of the window. Signals other than these types will show varying amounts of spectral leakage and scallop loss, which can be corrected by selecting another type of window.
Hanning (Von Hann)	These reduce leakage and improve amplitude accuracy. However, frequency resolution is also reduced.
Hamming	These reduce leakage and improve amplitude accuracy. However, frequency resolution is also reduced.
Flat Top	This window provides excellent amplitude accuracy with moderate reduction of leakage, but with reduced frequency resolution.
Blackman-Harris	It reduces the leakage to a minimum, but with reduced frequency resolution.

FFT Power Average

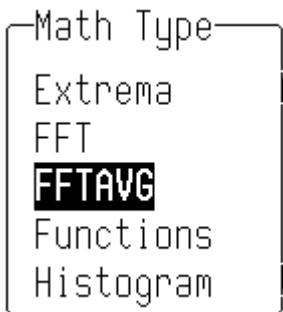

A function can be defined as the power average of FFT spectra computed by another function (see page C-6). Choose “FFTAVG” from the “Math Type” menu, and “Power Spect” from “FFT Result.”

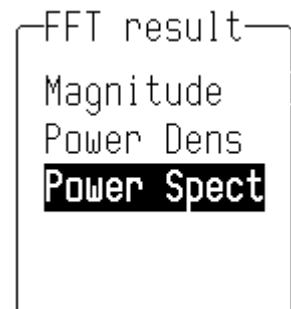



Appendix C: Fast Fourier Transform (FFT)

Additional Processing

Other waveform processing functions, such as Averaging and Arithmetic, can be applied to waveforms before FFT processing is performed. Time-domain averaging prior to FFT, for example, can be used if a stable trigger is available to reduce random noise in the signal.

Note:

- *To increase the FFT frequency range, the Nyquist frequency, raise the effective sampling frequency by increasing the maximum number of points or using a faster time base.*
- *To increase the FFT frequency resolution, increase the length of the time-domain waveform record by using a slower time base.*

Memory Status

When FFT is used, the field beneath the grid displays parameters of the waveform descriptor, including number of points, horizontal and vertical scale factors, and units.

```
C:PS(AVGP(B))
Power Spectrum    10000 -> 2500 pts
```

Using Cursors with FFT

For reading the amplitude and frequency of a data point, the Absolute Time cursor can be moved into the frequency domain by going beyond the right-hand edge of a time-domain waveform.

The Relative Time cursors can be moved into the frequency domain to simultaneously indicate the frequency difference and the amplitude difference between two points on each frequency-domain trace.

The Absolute Voltage cursor reads the absolute value of a point in a spectrum in the appropriate units, and the *Relative Voltage* cursors indicate the difference between two levels on each trace

Error Messages

One of these FFT-related error messages may be displayed at the top of the screen.

Error Messages	
Message	Meaning
“Incompatible input record type”	FFT power average is defined only on a function defined as FFT.
“Horizontal units don't match”	FFT of a frequency-domain waveform is not available.
“FFT source data zero filled”	If there are invalid data points in the source waveform (at the beginning or at the end of the record), these are replaced by zeros before FFT processing.
“FFT source data over/underflow”	The source waveform data has been clipped in amplitude, either in the acquisition — gain too high or inappropriate offset — or in previous processing. The resulting FFT contains harmonic components which would not be present in the unclipped waveform. The settings defining the acquisition or processing should be changed to eliminate the over/underflow condition.
“Circular computation”	A function definition is circular (i.e. the function is its own source, indirectly via another function or expansion). One of the definitions should be changed.



FFT Algorithms

A summary of the algorithms used in the oscilloscope's FFT computation is given here in the form of seven steps:

1. If the maximum number of points is smaller than the source number of points, the source waveform data are decimated prior to the FFT. These decimated data extend over the full length of the source waveform. The resulting sampling interval and the actual transform size selected provide the frequency scale factor in a 1–2–5 sequence.
2. The data are multiplied by the selected window function.
3. FFT is computed, using a fast implementation of the DFT (Discrete Fourier Transform):

$$X_n = \frac{1}{N} \sum_{k=0}^{k=N-1} x_k \times W^{nk}$$

where: x_k is a complex array whose real part is the modified source time domain waveform, and whose imaginary part is 0; X_n is the resulting complex frequency-domain waveform; $W = e^{-2\pi j/N}$; and N is the number of points in x_k and X_n .

The generalized FFT algorithm, as implemented here, works on N , which need *not* be a power of 2.

4. The resulting complex vector X_n is divided by the coherent gain of the window function, in order to compensate for the loss of the signal energy due to windowing. This compensation provides accurate amplitude values for isolated spectrum peaks.
5. The real part of X_n is symmetric around the Nyquist frequency, that is

$$R_n = R_{N-n}$$

while the imaginary part is asymmetric, that is

$$I_n = -I_{N-n}$$

LC SERIES FFT Algorithms

The energy of the signal at a frequency n is distributed equally between the first and the second halves of the spectrum; the energy at frequency 0 is completely contained in the 0 term.

The first half of the spectrum (Re, Im), from 0 to the Nyquist frequency is kept for further processing and doubled in amplitude:

$$R'_n = 2 \times R_n \quad 0 \leq n < N/2$$

$$I'_n = 2 \times I_n \quad 0 \leq n < N/2$$

6. The resultant waveform is computed for the spectrum type selected.

If "Real," "Imaginary," or "Real + Imaginary" is selected, no further computation is needed. The appropriate part of the complex result is given as the result (R'_n or I'_n or $R'_n + jI'_n$, as defined above).

If "Magnitude" is selected, the magnitude of the complex vector is computed as:

$$M_n = \sqrt{R_n'^2 + I_n'^2}$$

Steps 1–6 lead to the following result:

An AC sine wave of amplitude 1.0 V with an integral number of periods N_p in the time window, transformed with the rectangular window, results in a fundamental peak of 1.0 V magnitude in the spectrum at frequency $N_p \times \Delta f$. However, a DC component of 1.0 V, transformed with the rectangular window, results in a peak of 2.0 V magnitude at 0 Hz.

The waveforms for the other available spectrum types are computed as follows:

$$\text{Phase: angle} = \arctan (I_n/R_n) \quad M_n > M_{min}$$

$$\text{angle} = 0 \quad M_n \leq M_{min}$$



Appendix C: Fast Fourier Transform (FFT)

Where M_{min} is the minimum magnitude, fixed at about 0.001 of the full scale at any gain setting, below which the angle is not well defined.

The dBm Power Spectrum:

$$dBm PS = 10 \times \log_{10} \left(\frac{M_n^2}{M_{ref}^2} \right) = 20 \times \log_{10} \left(\frac{M_n}{M_{ref}} \right)$$

where $M_{ref} = 0.316$ V (that is, 0 dBm is defined as a sine wave of 0.316 V peak or 0.224 V RMS, giving 1.0 mW into 50Ω).

The dBm Power Spectrum is the same as dBm Magnitude, as suggested in the above formula.

dBm Power Density:

$$dBm PD = dBm PS - 10 \times \log_{10} (ENBW \times \Delta f)$$

where $ENBW$ is the equivalent noise bandwidth of the filter corresponding to the selected window, and Δf is the current frequency resolution (bin width).

7. The FFT Power Average takes the complex frequency-domain data R'_n and I'_n for each spectrum generated in Step 5, and computes the square of the magnitude:

$$M_n^2 = R_n'^2 + I_n'^2,$$

then sums M_n^2 and counts the accumulated spectra. The total is normalized by the number of spectra and converted to the selected result type using the same formulas as are used for the Fourier Transform.

Glossary

This section defines the terms frequently used in FFT spectrum analysis and relates them to the oscilloscope.

Aliasing

If the input signal to a sampling acquisition system contains components whose frequency is greater than the Nyquist frequency (half the sampling frequency), there will be less than two samples per signal period. The result is that the contribution of these components to the sampled waveform is indistinguishable from that of components below the Nyquist frequency. This is **aliasing**.

The timebase and transform size should be selected so that the resulting Nyquist frequency is higher than the highest significant component in the time-domain record.

Coherent Gain

The normalized coherent gain of a filter corresponding to each window function is 1.0 (0 dB) for a rectangular window and less than 1.0 for other windows. It defines the loss of signal energy due to the multiplication by the window function. This loss is compensated for in the oscilloscope. The following table lists the values for the implemented windows.

Window Frequency-Domain Parameters				
Window Type	Highest Side Lobe (dB)	Scallop Loss (dB)	ENBW (bins)	Coherent Gain (dB)
Rectangular	-13	3.92	1.0	0.0
von Hann	-32	1.42	1.5	-6.02
Hamming	-43	1.78	1.37	-5.35
Flat Top	-44	0.01	2.96	-11.05
Blackman-Harris	-67	1.13	1.71	-7.53



Appendix C: Fast Fourier Transform (FFT)

ENBW

Equivalent Noise BandWidth (ENBW) is the bandwidth of a rectangular filter (same gain at the center frequency), equivalent to a filter associated with each frequency bin, which would collect the same power from a white noise signal. In the table on the previous page, the ENBW is listed for each window function implemented, given in bins.

Filters

Computing an N-point FFT is equivalent to passing the time-domain input signal through N/2 filters and plotting their outputs against the frequency. The spacing of filters is $\Delta f = 1/T$, while the bandwidth depends on the window function used (see Frequency bins).

Frequency bins

The FFT algorithm takes a discrete source waveform, defined over N points, and computes N complex Fourier coefficients, which are interpreted as harmonic components of the input signal.

For a real source waveform (imaginary part equals 0), there are only N/2 independent harmonic components.

An FFT corresponds to analyzing the input signal with a bank of N/2 filters, all having the same shape and width, and centered at N/2 discrete frequencies. Each filter collects the signal energy that falls into the immediate neighborhood of its center frequency. Thus it can be said that there are N/2 “frequency bins.”

The distance in hertz between the center frequencies of two neighboring bins is always:

$$\Delta f = 1/T$$

where T is the duration of the time-domain record in seconds.

The width of the main lobe of the filter centered at each bin depends on the window function used. The rectangular window has a nominal width at 1.0 bin. Other windows have wider main lobes (see table).

Frequency Range

The range of frequencies computed and displayed is 0 Hz (displayed at the left-hand edge of the screen) to the Nyquist frequency (at the rightmost edge of the trace).

Frequency Resolution

In a simple sense, the frequency resolution is equal to the bin width Δf . That is, if the input signal changes its frequency by Δf , the corresponding spectrum peak will be displaced by Δf . For smaller changes of frequency, only the shape of the peak will change.

However, the effective frequency resolution (that is, the ability to resolve two signals whose frequencies are almost the same) is further limited by the use of window functions. The ENBW value of all windows other than the rectangular is greater than Δf and the bin width. The table on page C-17 lists the ENBW values for the implemented windows.

Leakage

In the power spectrum of a sine wave with an integral number of periods in the (rectangular) time window (that is, the source frequency equals one of the bin frequencies), the spectrum contains a sharp component whose value accurately reflects the source waveform's amplitude. For intermediate input frequencies this spectral component has a lower and broader peak.

The broadening of the base of the peak, stretching out into many neighboring bins is termed *leakage*. It is due to the relatively high side lobes of the filter associated with each frequency bin.

The filter side lobes and the resulting leakage are reduced when one of the available window functions is applied. The best reduction is provided by the Blackman-Harris and Flat Top windows. However, this reduction is offset by a broadening of the main lobe of the filter.

Number of Points

FFT is computed over the number of points (Transform Size) whose upper bounds are the source number of points, and by the maximum number of points selected in the menu. FFT generates spectra of $N/2$ output points.

Nyquist Frequency

The Nyquist frequency is equal to one half of the effective sampling frequency (after the decimation): $\Delta f \times N/2$.

Picket Fence Effect

If a sine wave has a whole number of periods in the time domain record, the power spectrum obtained with a rectangular window will have a sharp peak, corresponding exactly to the frequency and amplitude of the sine wave. Otherwise the spectrum peak with a rectangular window will be lower and broader.

The highest point in the power spectrum can be 3.92 dB lower (1.57 times) when the source frequency is halfway between two



Appendix C: Fast Fourier Transform (FFT)

discrete bin frequencies. This variation of the spectrum magnitude is called the *picket fence effect* (the loss is called the scallop loss).

All window functions compensate for this loss to some extent, but the best compensation is obtained with the Flat Top window.

Power Spectrum

The power spectrum (V^2) is the square of the magnitude spectrum.

The power spectrum is displayed on the dBm scale, with 0 dBm corresponding to:

$$V_{\text{ref}}^2 = (0.316 V_{\text{peak}})^2,$$

where V_{ref} is the peak value of the sinusoidal voltage, which is equivalent to 1 mW into 50 Ω .

Power Density Spectrum

The power density spectrum (V^2/Hz) is the power spectrum divided by the equivalent noise bandwidth of the filter, in hertz. The power density spectrum is displayed on the dBm scale, with 0 dBm corresponding to ($V_{\text{ref}}^2/\text{Hz}$).

Sampling Frequency

The time-domain records are acquired at sampling frequencies dependent on the selected time base. Before the FFT computation, the time-domain record may be decimated. If the selected maximum number of points is lower than the source number of points, the effective sampling frequency is reduced. The effective sampling frequency equals twice the Nyquist frequency.

Scallop Loss

This is loss associated with the picket fence effect.

Window Functions

All available window functions belong to the sum of cosines family with one to three non-zero cosine terms:

$$W_k = \sum_{m=0}^{m=M-1} a_m \cos \left(\frac{2 p k}{N} m \right) \quad 0 \leq k < N$$

where: $M = 3$ is the maximum number of terms, a_m are the coefficients of the terms, N is the number of points of the decimated source waveform, and k is the time index.

LC SERIES FFT Glossary

The following table lists the coefficients a_m . The window functions seen in the time domain are symmetric around the point $k = N/2$.

Coefficients Of Window Functions			
Window Type	a0	a1	a2
Rectangular	1.0	0.0	0.0
von Hann	0.5	-0.5	0.0
Hamming	0.54	-0.46	0.0
Flat-Top	0.281	-0.521	0.198
Blackman-Harris	0.423	-0.497	0.079

Appendix C References

Bergland, G.D., *A Guided Tour of the Fast Fourier Transform*, IEEE Spectrum, July 1969, pp. 41–52.

A general introduction to FFT theory and applications.

Brigham, E.O., *The Fast Fourier Transform*, Prentice Hall, Inc., Englewood Cliffs, N.J., 1974.

Theory, applications and implementation of FFT. Includes discussion of FFT algorithms for N not a power of 2.

Harris, F.J., *On the Use of Windows for Harmonic Analysis with the Discrete Fourier Transform*, Proceedings of the IEEE, vol. 66, No. 1, January 1978, pp. 51–83.

Classic paper on window functions and their figures of merit, with many examples of windows.

Ramirez, R.W., *The FFT Fundamentals and Concepts*, Prentice Hall, Inc., Englewood Cliffs, N.J., 1985.

Practice oriented, many examples of applications.

#



Appendix C: Fast Fourier Transform (FFT)

BLANK PAGE

Parameters and How They Work

In this Appendix, a general explanation of how the instrument's standard parameters are computed is followed by a table that defines and describes those parameters (page D-5).

Determining Top and Base Lines

Proper determination of the *top* and *base* reference lines is fundamental for ensuring correct parameter calculations. The analysis begins by computing a histogram of the waveform data over the time interval spanned by the left and right time cursors. For example, the histogram of a waveform transitioning in two states will contain two peaks (Fig. D-1). The analysis will attempt to identify the two clusters that contain the largest data density. Then the most probable state (centroids) associated with these two clusters will be computed to determine the *top* and *base* reference levels: the *top* line corresponds to the top and the *base* line to the bottom centroid.

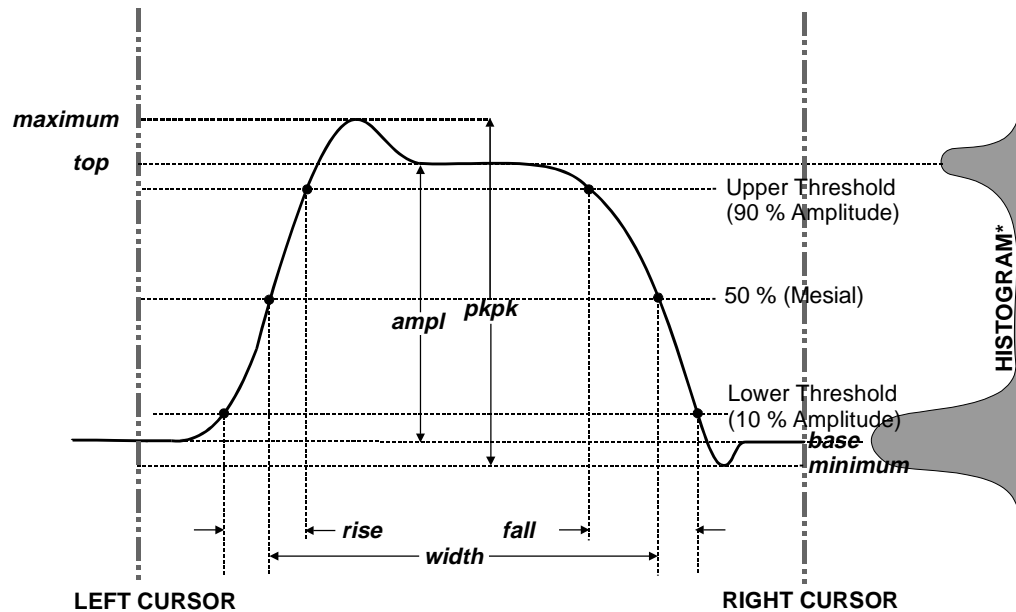

Figure D-1



Determining Rise and Fall Times

Once *top* and *base* are estimated, calculation of the *rise* and *fall* times is easily done (Fig.1). The 90% and 10% threshold levels are automatically determined by the oscilloscope, using the amplitude (*ampl*) parameter.

Threshold levels for *rise* or *fall* time can also be selected using absolute or relative settings (*r@level*, *f@level*). If absolute settings are chosen, the *rise* or *fall* time is measured as the time interval separating the two crossing points on a rising or falling edge. But when relative settings are chosen, the vertical interval spanned between the *base* and *top* lines is subdivided into a percentile scale (base = 0%, top = 100%) to determine the vertical position of the crossing points.

The time interval separating the points on the rising or falling edges is then estimated to yield the rise or fall time. These results are averaged over the number of transition edges that occur within the observation window.

Rising Edge Duration	$\frac{1}{Mr} \sum_{i=1}^{Mr} (Tr_i^{90} - Tr_i^{10})$
Falling Edge Duration	$\frac{1}{Mf} \sum_{i=1}^{Mf} (Tf_i^{10} - Tf_i^{90})$
Where <i>Mr</i> is the number of leading edges found, <i>Mf</i> the number of trailing edges found, Tr_i^x the time when rising edge <i>i</i> crosses the x% level, and Tf_i^x the time when falling edge <i>i</i> crosses the x% level.	

Determining Time Parameters

Time parameter measurements such as *width*, *period*, and *delay* are carried out with respect to the mesial reference level (Fig. D-2), located halfway (50%) between the top and base reference lines.

Time parameter estimation depends on the number of cycles included within the observation window. If the number of cycles is not an integer, parameter measurements such as *rms* or *mean* will be biased.

LC SERIES Parameter Measurement

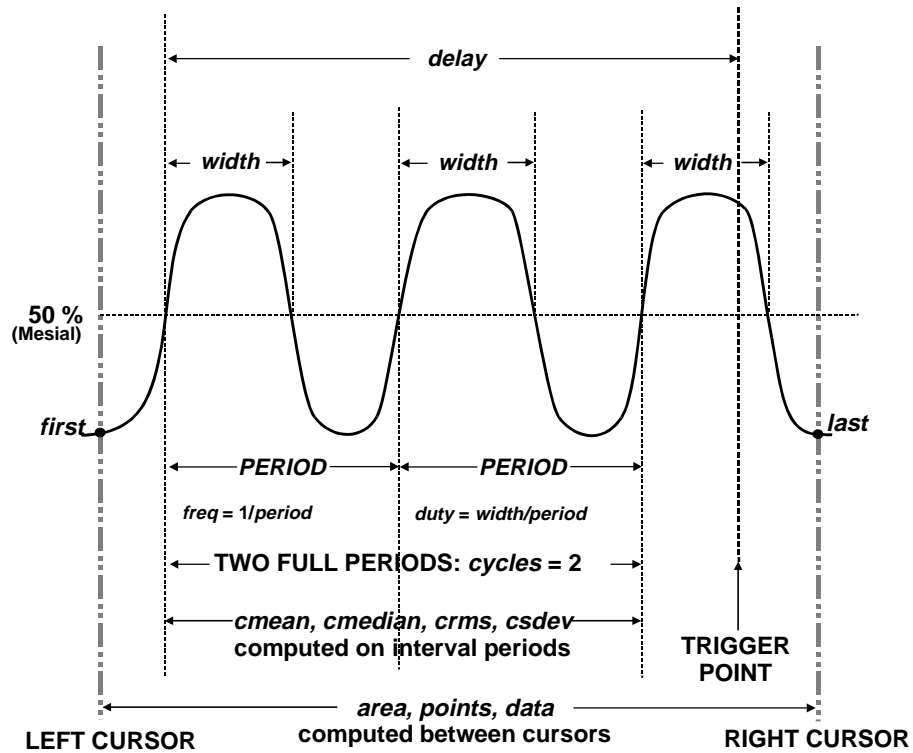

Figure D-2

To avoid these bias effects, the instrument uses cyclic parameters, including *crms* and *cmean*, that restrict the calculation to an integer number of cycles.

Determining Differential Time Measurements

The oscilloscope enables accurate differential time measurements between two traces — for example, propagation, setup and hold delays (Fig. D-3).

Parameters such as $\Delta c2d \pm$ require the transition polarity of the clock and data signals to be specified.

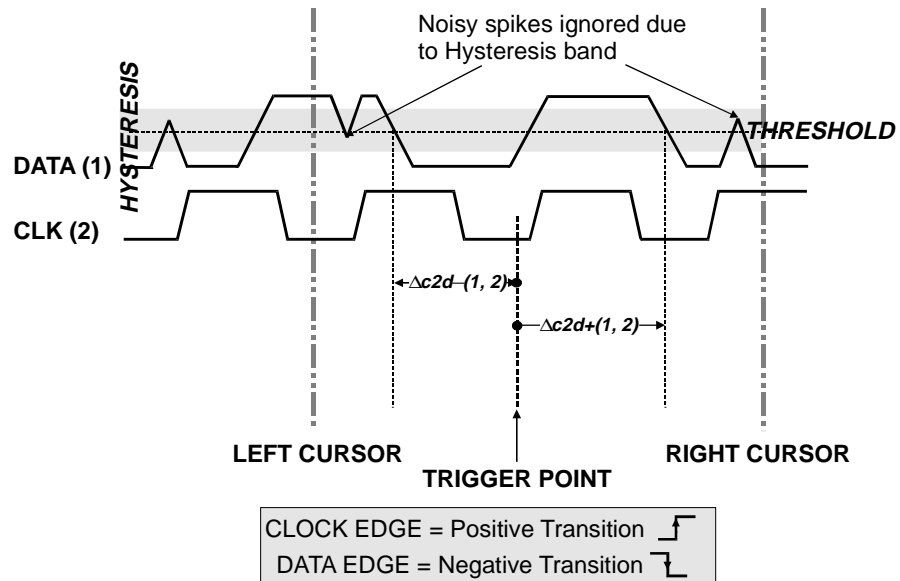

Figure D-3

Moreover, a hysteresis range may be specified to ignore any spurious transition that does not exceed the boundaries of the hysteresis interval. In Figure D-3, $\Delta c2d-(1, 2)$ measures the time interval separating the rising edge of the clock (trigger) from the first negative transition of the data signal. Similarly, $\Delta c2d+(1, 2)$ measures the time interval between the trigger and the next transition of the data signal.

LC SERIES Parameter Measurement

Parameter and what it does	Definition	Notes
ampl	Amplitude: Measures the difference between the upper and lower levels in two-level signals. Differs from <i>pkpk</i> in that noise, overshoot, undershoot, and ringing do NOT affect measurement.	$top - base$ (See Fig. D-1) <i>On signals NOT having two major levels (such as triangle or saw-tooth waves), returns same value as pkpk.</i>
area	Integral of data: Computes area of waveform between cursors relative to zero level. Values greater than zero contribute positively to the area; values less than zero negatively.	Sum from <i>first</i> to <i>last</i> of data multiplied by horizontal time between points (See Fig. D-2)
base	Lower of two most probable states (higher is <i>top</i>). Measures lower level in two-level signals. Differs from <i>min</i> in that noise, overshoot, undershoot, and ringing do NOT affect measurement.	Value of most probable lower state (See Fig. D-1) <i>On signals NOT having two major levels (triangle or saw-tooth waves, for example), returns same value as min.</i>
cycles	Determines the number of cycles of a periodic waveform lying between cursors. The first cycle begins at the first transition after the left cursor. The transition may be positive or negative going.	Number of cycles of periodic waveform (See Fig. D-2)
cmean	Cyclic mean: Computes the average of waveform data. Contrary to <i>mean</i> , computes the average over an integral number of cycles, eliminating bias caused by fractional intervals.	Average of data values of an integral number of periods
cmedian	Cyclic median: Computes the average of base and top values over an integral number of cycles, contrary to <i>median</i> , eliminating bias caused by fractional intervals.	Data value for which 50% of values are above and 50% below
crms	Cyclic root mean square: Computes the square root of the sum of squares of data values divided by the number of points. Contrary to <i>rms</i> , calculation is performed over an integral number of cycles, eliminating bias caused by fractional intervals.	$\sqrt{\frac{1}{N} \sum_{i=1}^N (v_i)^2}$ <i>Where: v_i denotes measured sample values, and N = number of data points within the periods found up to maximum of 100 periods.</i>

Parameter and what it does	Definition	Notes
csdev	Cyclic standard deviation: Standard deviation of data values from the mean value over an integral number of periods. Contrary to <i>sdev</i> , the calculation is performed over an integral number of cycles, eliminating bias caused by fractional intervals.	$\sqrt{\frac{1}{N} \sum_{i=1}^N (v_i - \text{mean})^2}$ <i>Where: v_i denotes measured sample values, and N = number of data points within the periods found up to maximum of 100 periods.</i>
data	Returns the average of all data points.	All data values in analyzed region (See Fig. D-2) <i>Multi-value parameter especially valuable for histograms and trends.</i>
delay	The time from trigger to transition: Measures the time between trigger and first 50% crossing after the left cursor. It can measure propagation delay between two signals by triggering on one and determining delay of the other.	Time between trigger and first 50% crossing after left cursor (See Fig. D-2)
Δdly	Δ delay: Computes time between the 50% level of two sources.	Time between midpoint transition of two sources
Δt@lv	Δ t at level: Computes the transition between selected levels or sources.	Time between transition levels of two sources, or from trigger to transition level of a single source <i>Reference levels and edge-transition polarity can be selected. Hysteresis argument is used to discriminate levels from noise in data.</i>
Δc2d\pm	Δ clock to data \pm : Computes the difference in time from the clock threshold crossing to either the next (Δ c2d+) or previous (Δ c2d-) data threshold crossing.	Time from clock threshold crossing to next or previous edge (See Fig. D-3) <i>Threshold levels of clock and data signals, and edge-transition polarity can be selected. Hysteresis argument is used to differentiate peaks from noise in data, with a good hysteresis value between half expected peak-to-peak value of signal and twice expected peak-to-peak value of noise.</i>

LC SERIES Parameter Measurement

Parameter and what it does		Definition	Notes															
dur	For single sweep waveforms, <i>dur</i> is 0. For sequence waveforms: time from first to last segment's trigger. For single segments of sequence waveforms: time from previous segment's to current segment's trigger. For waveforms produced by a history function: time from first to last accumulated waveform's trigger.	Time from first to last acquisition — for average, histogram or sequence waveforms																
duty	Duty cycle: Width as percentage of period.	<i>width/period</i> (See Fig. D-2)																
f80-20%	Fall 80-20%: Duration of a pulse waveform's falling transition from 80% to 20%, averaged for all falling transitions between the cursors.	Average duration of falling 80-20% transition	<i>On signals NOT having two major levels (triangle or saw-tooth waves, for example), top and base can default to maximum and minimum, giving, less predictable results, however.</i>															
f@level	Fall at level: Duration of pulse waveform's falling edges between transition levels.	Duration of falling edge between transition levels	<i>On signals NOT having two major levels (triangle or saw-tooth waves, for example), top and base can default to maximum and minimum, giving, less predictable results, however.</i>															
fall	Fall time: Measures the time between two specified values on falling edges of a waveform. Fall times for each edge are averaged to produce the final result.	Time at lower threshold - Time at upper threshold averaged over each falling edge (See Fig. D-1)	<i>On signals NOT having two major levels (triangle or saw-tooth waves, for example), top and base can default to maximum and minimum, giving, less predictable results, however.</i>															
	Arguments																	
	<table border="1"> <thead> <tr> <th>Threshold</th> <th>Remote</th> <th>Lower Limit</th> <th>Upper Limit</th> <th>Default</th> </tr> </thead> <tbody> <tr> <td>Lower</td> <td>low</td> <td>1%</td> <td>45%</td> <td>10%</td> </tr> <tr> <td>Upper</td> <td>high</td> <td>55%</td> <td>99%</td> <td>90%</td> </tr> </tbody> </table>			Threshold	Remote	Lower Limit	Upper Limit	Default	Lower	low	1%	45%	10%	Upper	high	55%	99%	90%
	Threshold			Remote	Lower Limit	Upper Limit	Default											
	Lower			low	1%	45%	10%											
Upper	high	55%	99%	90%														
Threshold arguments specify two vertical values on each edge used to compute fall time. Formulas for upper and lower values:																		
lower value = lower threshold $\times \frac{amp}{100} + base$ upper value = upper threshold $\times \frac{amp}{100} + base$																		



Parameter and what it does	Definition	Notes
first	Indicates the value of the horizontal axis at the left cursor.	Horizontal axis value at left cursor (See Fig. D-2) <i>Indicates location of left cursor. Cursors are interchangeable: for example, the left cursor may be moved to the right of the right cursor and first will give the location of the cursor formerly on the right, now on the left.</i>
freq	Frequency: The period of a cyclic signal measured as the time between every other pair of 50% crossings. Starting with the first transition after the left cursor, the period is measured for each transition pair. Values are then averaged and the reciprocal used to give frequency.	1/period (See Fig. D-2)
last	Time from trigger to the last (rightmost) cursor.	Time from trigger to last cursor (See Fig. D-2) <i>Indicates location of the right cursor. Cursors are interchangeable: for example, the right cursor may be moved to the left of the left cursor and first will give the location of the cursor formerly on the left, now on the right.</i>
maximum	Measures the highest point in the waveform. Unlike <i>top</i> , it does NOT assume that the waveform has two levels.	Highest value in waveform between cursors (See Fig. D-1) <i>Gives similar result when applied to a time domain waveform, or to a histogram of data of the same waveform. But with histograms, the result may include contributions from more than one acquisition. Computes horizontal axis location of rightmost non-zero bin of histogram; not to be confused with maxp.</i>
mean	Average of <i>data</i> for a time domain waveform. Computed as the centroid of distribution for a histogram. But when input is a periodic time domain waveform, it is computed on an integral number of periods.	Average of <i>data</i> (See Fig. D-2) <i>Gives similar result when applied to a time domain waveform or histogram of data of the same waveform. But with histograms, the result may include contributions from more than one acquisition.</i>

LC SERIES Parameter Measurement

Parameter and what it does		Definition	Notes
median	The average of base and top values.	Average of <i>base</i> and <i>top</i> (See Fig. D-2)	
minimum	Measures the lowest point in a waveform. Unlike <i>base</i> , it does NOT assume the waveform has two levels.	Lowest value in a waveform between cursors (See Fig. D-1)	<i>Gives a similar result when applied to a time domain waveform or histogram of data of the same waveform. But with histograms, the result may include contributions from more than one acquisition.</i>
over-	Overshoot negative: The amount of overshoot following a falling edge, expressed as a percentage of amplitude.	$\frac{(base - minimum)}{ampl} \times 100$ (See Fig. D-2)	<i>The waveform must contain at least one falling edge. On signals NOT having two major levels (triangle or saw-tooth waves, for example), it may NOT give predictable results.</i>
over+	Overshoot positive: The amount of overshoot following a rising edge, expressed as a percentage of amplitude.	$\frac{(maximum - top)}{ampl} \times 100$ (See Fig. D-1)	<i>Waveform must contain at least one rising edge. On signals NOT having two major levels (triangle or saw-tooth waves, for example), it may NOT give predictable results.</i>
period	The period of a cyclic signal measured as the time between every other pair of 50% crossings. Starting with the first transition after the left cursor, the period is measured for each transition pair, with values averaged to give a final result.	$\frac{1}{Mr} \sum_{i=1}^{Mr} (Tr_i^{50} - Tr_i^{50})$ (See Fig. D-2)	<i>Where: Mr is the number of leading edges found, Mf the number of trailing edges found, Tr_i^x the time when rising edge i crosses the x% level, and Tf_i^x the time when falling edge i crosses the x% level.</i>
pkpk	Peak-to-peak: The difference between the highest and lowest points in a waveform. Unlike <i>ampl</i> , it does not assume the waveform has two levels.	<i>maximum - minimum</i> (See Fig. D-1)	<i>Gives a similar result when applied to a time domain waveform or histogram of data of the same waveform. But with histograms, the result may include contributions from more than one acquisition.</i>
phase	The phase difference between the signal analyzed and the signal used as reference.	Phase difference between signal and reference	
points	The number of points in the waveform between the cursors.	Number of points between cursors (See Fig. D-2)	



Parameter and what it does	Definition	Notes																				
r20–80% Rise 20% to 80%: The duration of the pulse waveform's rising transition from 20% to 80%, averaged for all rising transitions between the cursors.	Average duration of rising 20–80 % transition	<i>On signals NOT having two major levels (triangle or saw-tooth waves, for example), top and base can default to maximum and minimum, giving, less predictable results, however.</i>																				
r@level Rise at level: The duration of a pulse waveform's rising edges between transition levels.	Duration of rising edges between transition levels	<i>On signals NOT having two major levels (triangle or saw-tooth waves, for example), top and base can default to maximum and minimum, giving, less predictable results, however.</i>																				
rise Rise time: Measures the time between two specified values on a waveform's rising edge (10–90%). Rise times for each edge are averaged to give a final result. <table border="1" data-bbox="370 877 834 1087" style="margin: 10px auto;"> <thead> <tr> <th colspan="5">Arguments</th> </tr> <tr> <th>Threshold</th> <th>Remote</th> <th>Lower Limit</th> <th>Upper Limit</th> <th>Default</th> </tr> </thead> <tbody> <tr> <td>Lower</td> <td>low</td> <td>1%</td> <td>45%</td> <td>10%</td> </tr> <tr> <td>Upper</td> <td>high</td> <td>55%</td> <td>99%</td> <td>90%</td> </tr> </tbody> </table> <p>Threshold arguments specify two vertical values on each edge used to compute rise time.</p> <p>Formulas for upper and lower values:</p> $\text{lower value} = \text{lower threshold} \times \frac{\text{amp}}{100} + \text{base}$ $\text{upper value} = \text{upper threshold} \times \frac{\text{amp}}{100} + \text{base}$	Arguments					Threshold	Remote	Lower Limit	Upper Limit	Default	Lower	low	1%	45%	10%	Upper	high	55%	99%	90%	Time at upper threshold - Time at lower threshold averaged over each rising edge (See Fig. D–1)	<i>On signals NOT having two major levels (triangle or saw-tooth waves, for example), top and base can default to maximum and minimum, giving, less predictable results, however.</i>
Arguments																						
Threshold	Remote	Lower Limit	Upper Limit	Default																		
Lower	low	1%	45%	10%																		
Upper	high	55%	99%	90%																		

LC SERIES Parameter Measurement

Parameter and what it does	Definition	Notes
rms Root Mean Square of data between the cursors — about the same as <i>sdev</i> for a zero-mean waveform.	$\sqrt{\frac{1}{N} \sum_{i=1}^N (v_i)^2}$ <p>(See Fig. D-2)</p>	<i>Where: v_i denotes measured sample values, and N = number of data points within the periods found up to a maximum of 100 periods. Gives a similar result when applied to a time domain waveform or histogram of data of the same waveform. But with histograms, the result may include contributions from more than one acquisition.</i>
sdev Standard deviation of the data between the cursors — about the same as <i>rms</i> for a zero-mean waveform.	$\sqrt{\frac{1}{N} \sum_{i=1}^N (v_i - \text{mean})^2}$ <p>(See Fig. D-2)</p>	<i>Where: v_i denotes measured sample values, and N = number of data points within the periods found up to maximum of 100 periods. Gives a similar result when applied to a time domain waveform or to a histogram of data of the same waveform. But with histograms, the result may include contributions from more than one acquisition.</i>
t@level Time at level: The time from trigger ($t=0$) to crossing at a specified level.	Time from trigger to crossing level	
top Higher of two most probable states, the lower being <i>base</i> . This is characteristic of rectangular waveforms and represents the higher most probable state determined from the statistical distribution of <i>data</i> point values in the waveform.	Value of most probable higher state (See Fig. D-1)	<i>Gives similar result when applied to time domain waveform or histogram of data of same waveform. But with histograms, result may include contributions from more than one acquisition.</i>
width The width of a cyclic signal determined by examining 50% crossings in the data input. If the first transmission after the left cursor is a rising edge, the waveform is considered to consist of positive pulses, and <i>width</i> the time between adjacent rising and falling edges. Conversely, if it is a falling edge, pulses are considered negative, and <i>width</i> the time between adjacent falling and rising edges. For both cases, widths of all waveform pulses are averaged for a final result.	Width of first positive or negative pulse averaged for all similar pulses (See Figs. 1, 2)	<i>Similar to fwhm, which applies only to histograms, however.</i>

#



BLANK PAGE

Using ASCII-Stored Files

The ASCII waveform storage feature allows waveforms to be saved to a mass-memory device in any of three ASCII formats: Spreadsheet, MathCad, and MATLAB. Each format is tailored for a commonly used analysis package. The user-interface changes that support ASCII waveform storage are found in the STORE menu (see Chapter 13).

The table below summarizes the basic layout of the three formats. Examples of the use of each format are given on the following pages. Your PC screen indicates the model name and serial number of the instrument being used.

Format	Header <i>Format includes some form of header before the data</i>	Time Values <i>Format stores time values with each amplitude value</i>	Amplitude Values <i>Format stores amplitude values</i>	Sequence Times <i>Header contains sequence time information for each sequence segment</i>	Multi-Segment <i>Format concatenates multiple segments of a sequence waveform</i>	Dual Array <i>Format allows dual-array data (i.e. Extrema, or complex FFT) to be stored</i>
Spreadsheet	Yes	Yes	Yes	Yes	Yes	Yes
MathCad	Yes	Yes	Yes	Yes	Yes	Yes
MATLAB	No	No	Yes	No	Yes	No

Note: Once stored in ASCII, waveforms cannot be recalled into the DSO.



Using the Spreadsheet Format with Excel

This example was created using Microsoft Excel for Windows. A waveform stored in Spreadsheet format may be read into Microsoft Excel using the File -> Open window:

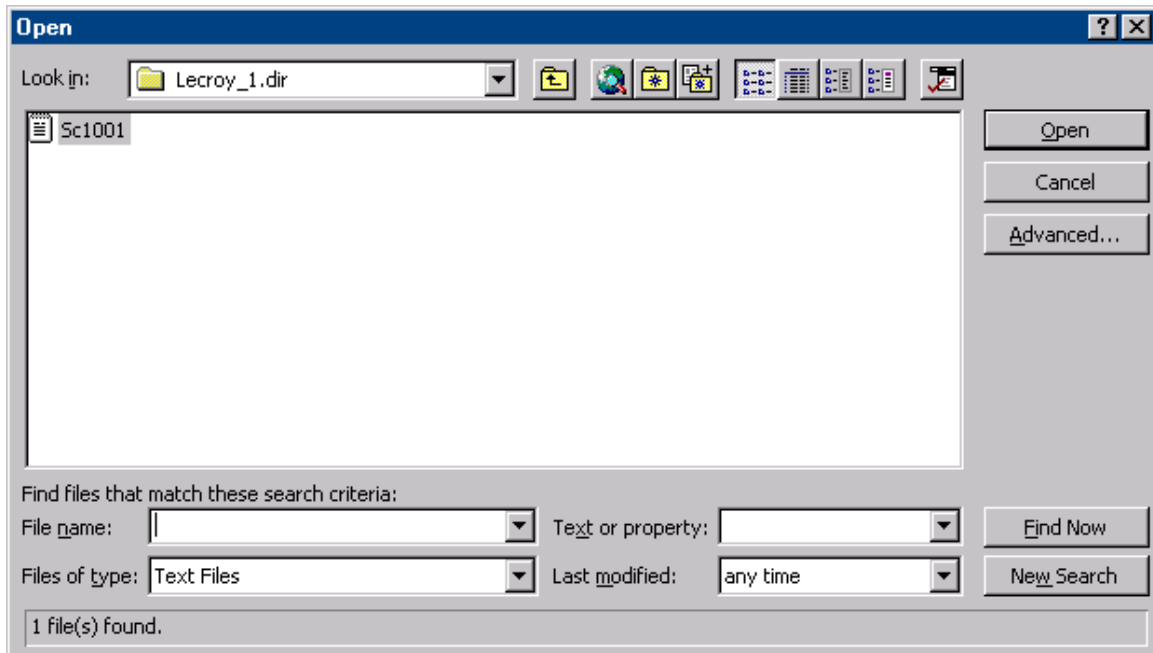

Excel will now ask for more information about the file type. Ensure that the 'Delimited' option is selected in the first step of the Wizard.

LC SERIES ASCII Waveform Export

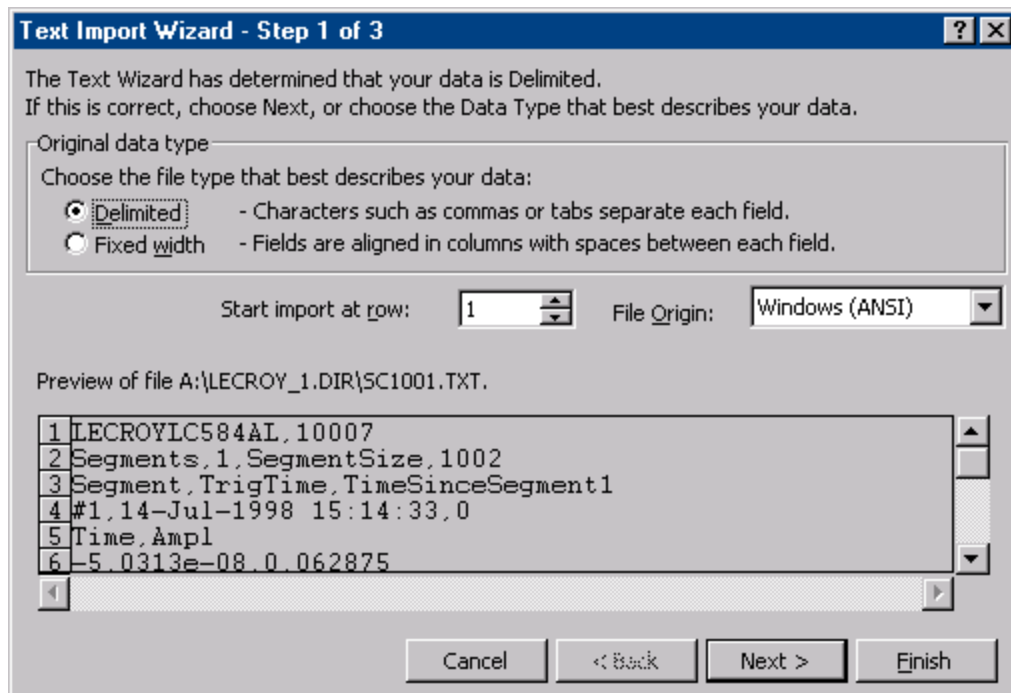

The next step allows the specific delimiter to be specified. The Spreadsheet format generated by the instrument uses a comma (,) to delimit columns. Ensure that this is selected.

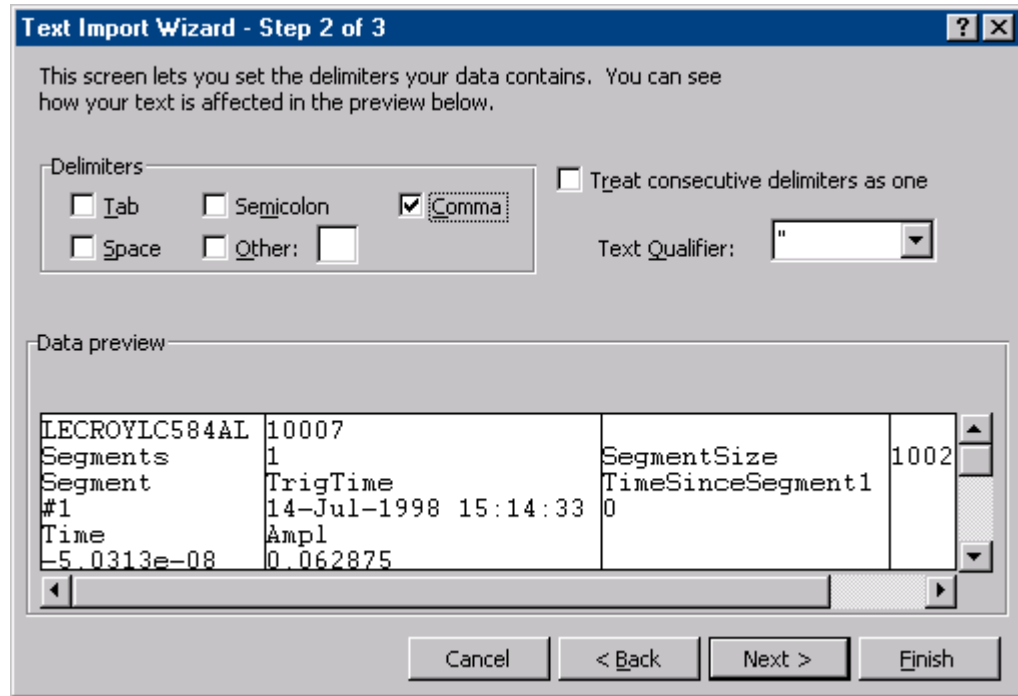

The third and final step allows the format of the columns to be specified. The 'general' format for each column should be used (this is the default).

LC SERIES ASCII Waveform Export

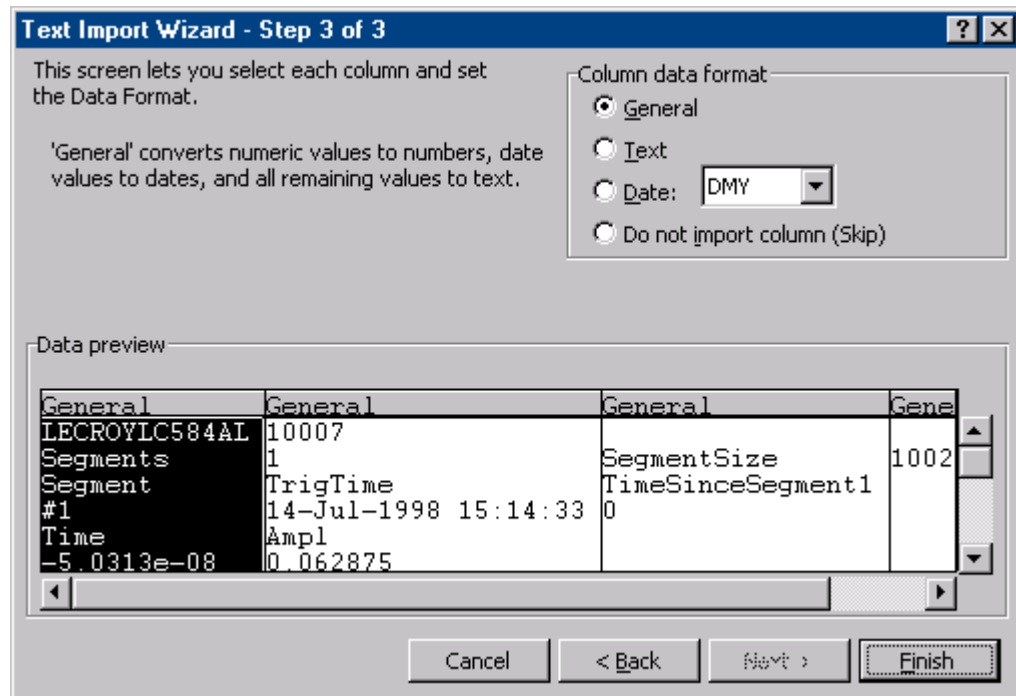

After you click the Finish button, a display similar to that following should appear.



Appendix E

Microsoft Excel - Sc1001

File Edit View Insert Format Tools Data Window Help

Arial 10 B I U \$ % , +.0 .00 +.0

H1 =

	A	B	C	D
1	LECROYLC584AL	10007		
2	Segments	1	SegmentSize	1002
3	Segment	TrigTime	TimeSinceSegment1	
4	#1	14-Jul-1998 15:14:33	0	
5	Time	Ampl		
6	-5.03E-08	0.062875		
7	-4.98E-08	0.062875		
8	-4.93E-08	0.061625		
9	-4.88E-08	0.06225		
10	-4.83E-08	0.05975		
11	-4.78E-08	0.060375		
12	-4.73E-08	0.059125		
13	-4.68E-08	0.0585		
14	-4.63E-08	0.057875		

LC SERIES ASCII Waveform Export

Plotting a Waveform

Plotting the data from a waveform requires the use of a scatter plot based on the data in the first two columns, with the first column used as the X values (from Row 6 in this example).

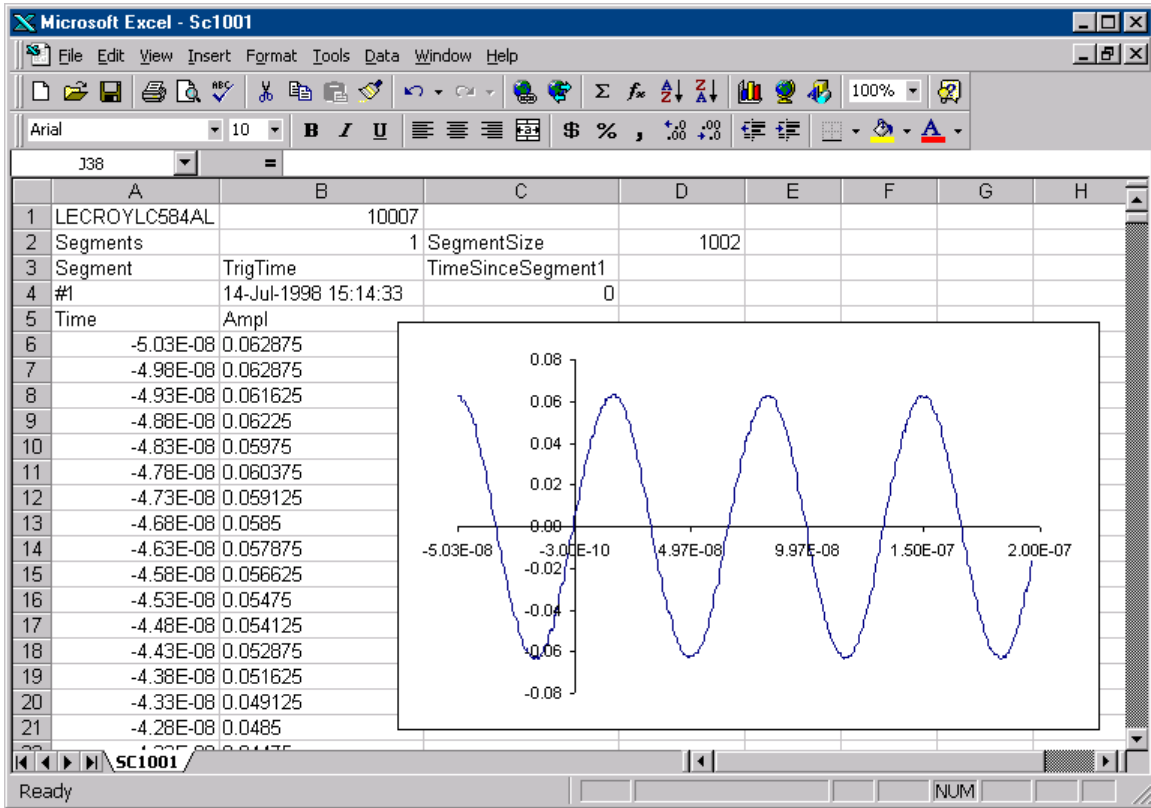



Extracting Segments from Sequence Waveforms

The header created for the Spreadsheet format contains all the information required to extract various elements of a sequence waveform. The following formulas may be used to extract information such as the start and end row of the data for a given segment, or the trigger time of a given segment.

SegmentStartRow := (*DesiredSegment* * D2) + B2 + 5

SegmentEndRow := *SegmentStartRow* + D2 - 1

TrigTime = INDIRECT(ADDRESS(*DesiredSegment* + 3; 2; 4))

TimeSinceFirstTrig = INDIRECT(ADDRESS(*DesiredSegment* + 3; 3; 4))

Plotting the data from all segments using a scatter plot will result in all segments overlaid (similar to the oscilloscope's display of sequence traces in persistence mode).

Using MathCad

These examples were created using MathSoft's MathCad for Windows. *On this page, the procedure for reading and graphing a file for a single segment is shown. The example on page E-10 is for multiple segments.*

Single-Segment

This single-segment example is valid for MathCad Versions 3.1 to 7:

```
A := READPRN(file)
K := last(A<0>)
A := submatrix(A, 2, K, 0, 1)      Create a submatrix containing data but no header
t := A<0>                          Extract time vector
v := A<1>                          Extract amplitude vector
K := last(t)                       Determine index of last point
k := 0..K - 1                      Create a ramp
```

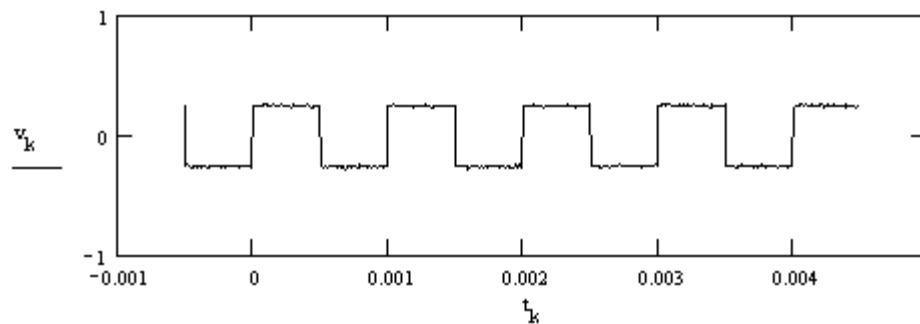



Multi-Segment Example

The following MathCad example demonstrates how to extract data from a given segment. The data used for this example consisted of two segments of three samples each, allowing the entire imported matrix to be shown.

Read data from file

$a := \text{READPRN}(\text{sc1000})$

Extracting the first segment only (or only segment if not sequence trace)

$n := (1 + a_{0,0}) \cdot (a_{0,0} + a_{0,1})$

$m := 0..1$

$\text{firstseg}_{n-1-a_{0,0},m} := a_{n,m}$

$\text{firstseg} = \begin{pmatrix} 1 & 1 \\ 1.1 & 2 \\ 1.2 & 3 \end{pmatrix}$

n

3

4

5

$a = \begin{bmatrix} 2 & 3 \\ 1 & 0 \\ 2 & 999 \\ 1 & 1 \\ 1.1 & 2 \\ 1.2 & 3 \\ 1 & 1.1 \\ 1.1 & 2.1 \\ 1.2 & 3.1 \end{bmatrix}$

Extracting a given segment

$\text{numsegments} := a_{0,0}$

Total number of segments in trace

$\text{seglen} := a_{0,1}$

Number of samples in each segment

$\text{segment} := 0$

Desired segment number

$\text{segstart} := 1 + \text{numsegments} \cdot \text{segment}$

Index of first point in segment

$\text{segend} := \text{segstart} + \text{seglen} - 1$

Index of last point in segment

$\text{segtime} := a_{\text{segment}+1,1}$

Segment trigger time

$x := a^{<0>}$

$y := a^{<1>}$

$i := \text{segstart}.. \text{segend}$

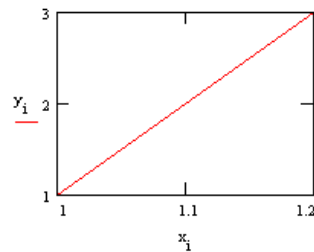

Using MATLAB

This example was created using MathWorks' MATLAB Version 4.2c.1 for Windows.

Reading and graphing a waveform in MATLAB may be achieved with two simple commands, as the following example shows. The first command loads the file into a matrix which is automatically named after the file. The second command plots this matrix.

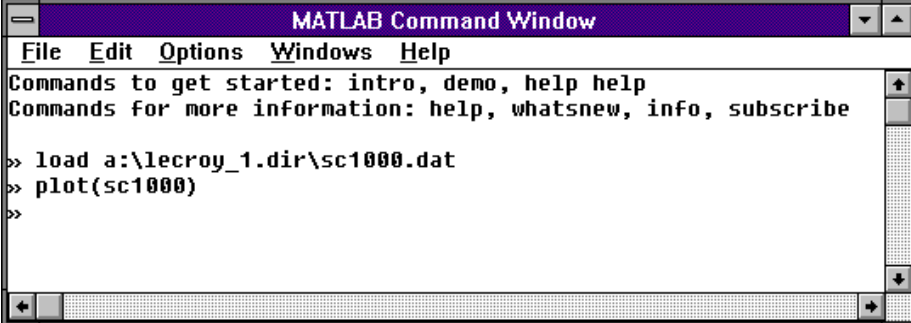
A screenshot of the MATLAB Command Window. The title bar reads "MATLAB Command Window". The menu bar includes "File", "Edit", "Options", "Windows", and "Help". The text area contains the following commands:

```
Commands to get started: intro, demo, help help
Commands for more information: help, whatsnew, info, subscribe

>> load a:\lecroy_1.dir\sc1000.dat
>> plot(sc1000)
>>
```

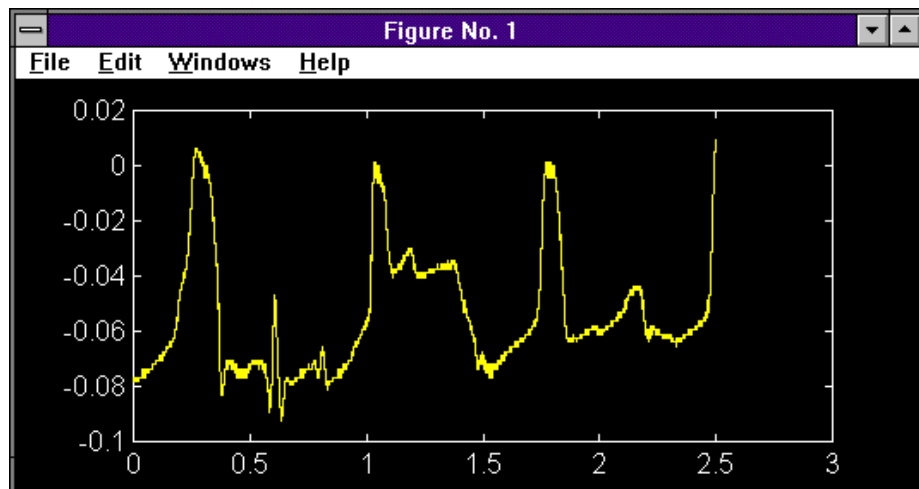



Detailed Description of the Formats

Spreadsheet

Format

Note: Fields in bold type are constants that are present in the output file, as shown. Fields in *italic* are variables that are filled in when the file is written.

```

<scopeid>,          <scopeserial>
Segments,        <numseg>,          SegmentSize,
  <numpts>
Segment,        TrigTime,
  TimeSinceFirstSegment
#1,                <trigtime(1)>,          0.0
...
#<numseg>,        <trigtime(numseg)>,
  <trigdelta(numseg)>
Time,          Ampl,          [Ampl1]
x(0),             y(0),           [y1(0)]
x(1),             y(1),           [y2(0)]
...
x(numgseg*numpts), y(numseg*numpts),
[y1(numseg*numpts)]

```

Single-Segment Example

```

LECROYLC584AL,LC58412345
Segments,1,SegmentSize,502
Segment,Trig Time,TimeSinceFirstSegment
#1,21 Mar 1990 9:37:08,0.0
Time,Ampl
0.0,1
0.1,2
...

```

Multi-Segment Example

```
LECROYLC584AL,LC58412345
Segments,3,SegmentSize,502
Segment,Trig Time,TimeSinceFirstSegment
#1,21 Mar 1990 9:37:08,0.0
#2,21 Mar 1990 9:37:13,5.0
#3,21 Mar 1990 9:37:15,7.0
Time,Ampl
0.0,1
0.1,2
...
0.0,1.1
0.0,2.1
...
0.0,1.05
0.0,2.05
```

Dual-Array Example

```
LECROYLC584AL,LC58412345
Segments,1,SegmentSize,502
Segment,Trig Time,TimeSinceFirstSegment
#1,21 Mar 1990 9:37:08,0.0
Time,Ampl
0.0,1.1,1.1
0.1,2.1,2.1
...
```

Note:

- *The basic structure of the Spreadsheet format is a header containing scope identification information, followed by a block containing trigger times for multi-segment waveforms, followed by the data itself.*
- *This format is compatible with the ASCII import of the LeCroy LW4xx Arbitrary Function Generator.*



MathCad

Format

```
<"scopeid">  
<"TriggerTime">  
<numseg>           <numpts>  
Segment          TimeSinceFirstSegment  
1                   0.0  
...  
<numseg>           <trigdelta(numseg)>  
Time             Ampl           Ampl1  
<x(0)>             <y(0)>           [<y1(0)>]  
<x(1)>             <y(1)>           [<y1(1)>]  
...  
<x(numgseg*numpts)> <y(numseg*numpts)>  
                    [<y1(numseg*numpts)>]
```

Single-Segment Example

```
"LECROYLC584AL,LC58412345"  
"23-March-90,12:44:23"  
1           502  
Segment     TimeSinceFirstSegment  
1           0.0  
Time        Ampl  
0.0         1  
0.1         2  
.....
```

LC SERIES ASCII Waveform Export

Multi-Segment Example

```
"LECROYLC584AL,LC58412345"  
"23-March-90,12:44:23"  
3          502  
Segment    TimeSinceFirstSegment  
1          0.0  
2          5.0  
3          7.0  
Time       Ampl  
0.0        1  
0.1        2  
.....  
0.0        1.1  
0.1        2.1  
.....  
0.0        1.05  
0.1        2.05
```

Note:

- *The format created for MathCad is very similar to the Spreadsheet format, but with some differences due to the way MathCad interprets the header information.*
- *One of the most important of these is that the absolute trigger time is only given for the first segment, with relative times (in units of seconds) included for each segment.*
- *Another difference is that the scope identification and trigger time are wrapped in quotes to ensure that MathCad does not attempt to import them.*



MATLAB Files

Format

```
y(0)  
y(1)  
...  
y(numseg*numpts)
```

Single-Segment Example

```
1.0  
1.1  
1.2  
...  
4.5
```

Notes

- *The MATLAB format is simple, without header information and having amplitude values only.*
- *Multiple segments will be appended without a separator.*
- *Only one value from the pair of amplitude values present in a dual-array will be stored.*

#

A

AC, 3-2, 8-5, C-15
 Acquisition Memory, C-4
 increasing it by combining
 channels, 2-1, 7-5
 Acquisition Modes, 6-1, 7-6, A-4
 Acquisition Summary, 5-3, 6-3,
 16-1
 Acquisition Summary field, 4-9
 Adapter, 1-3
 ADC (Analog-to-Digital
 Converter), 2-1, 7-1, 7-2, 7-5
 Add new Directory, 12-15
 Advanced Color Management,
 2-3, 11-1, 11-2
 Aliasing, C-5, C-17
 Altitude, A-11
 Amplitude, 12-23, 14-7, D-5
 in FFT, 10-19
 Analog
 Single Sweep, 11-17
 ANALOG PERSIST, 4-2, 11-13,
 11-14
 Analog Persistence™, 2-3, 11-1,
 11-5, 11-15, 11-19, A-8
 Area, D-5
 Arithmetic Setup, 10-9
 as, 8-39
 ASCII, 13-1, 13-2, 13-3, E-1
 ASCII Formats, A-11, E-1, E-2,
 E-3, E-4, E-7, E-8, E-9, E-10,
 E-11, E-12, E-13, E-14, E-15,
 E-16
 Audible feedback, 12-21
 AUTO, 6-2, 7-11
 Auto Scroll, 10-8
 AUTO SCROLL menus, 10-8
 AUTO SETUP, 4-2, 4-7, A-7
 Autocalibration, 2-2, 12-19, A-11
 Auto-Combine Mode, 7-7
 Automatic, 7-7
 Automatic Recalibration, 12-19
 autoprint, 12-3
 Autosetup, A-7

Auto-Store, 12-9, 13-2
 Average, A-9
 Average Setup, 10-10
 Averaging, B-3

B

Background, 11-2, 11-21, 12-2
 BACKSPACE, 12-16, 12-17
 Bandwidth, A-1
 Bandwidth Limiter, A-3
 Bandwidth Limiting (BWL), 5-3,
 5-6
 Base, D-1, D-2, D-5
 Battery, 12-10, A-11
 Baud Rate, 12-6
 Bi-level. *See* Window Pattern
 Trigger
 Binary, 13-1, 13-2
 Block diagram
 LC334/374/534/574 Series,
 2-4
 LC564/584 Series, 2-5
 BMP, 12-2, 12-8
 Boolean AND, 8-21

C

Cabling
 Printer, 12-5
 CAL BNC Setup, 12-1, 12-23
 CAL/BNC, 14-15
 Calibration, 2-2, 5-5, 12-19, 12-23,
 A-11
 Capture information, 4-9
 Capture Time, 10-18
 CAUTION, 3-1
 Centroids, D-1
 Centronics, 12-2, 12-3
 Change, 11-22
 CHANGE COLORS, 11-20
 CHANGE PARAM, 14-11, 14-12
 CHANGE PARAMETERS, 14-10
 Channels, A-1
 CHANNELS, 4-2
 character, 12-16, 12-17



- Chassis Terminal, 3-2
 - Circuit Failures
 - testing for using Exclusion Trigger, 8-11
 - Cleaning and Maintenance, 3-3
 - CLEAR INACTIVE menu, 16-5
 - CLEAR SWEEPS, 4-6, 10-3, 10-4, 10-14, 11-14, 14-8, 14-9, 14-10
 - Clock Accuracy, A-5
 - Clock Edge, 14-14, D-4
 - cm/division, 12-3
 - Coherent Gain, C-17
 - Color
 - Changing Colors, 11-20, 11-21, 11-22
 - Copying Color Schemes, 11-22
 - Color Association, 11-1, 11-2
 - Color Control, 11-20
 - Color Graded Persistence, 11-1, 11-15, 11-17, 11-19, A-8
 - Color Links, 11-1, 11-3
 - Color Management, 11-1, 11-2, 11-4
 - Color Palettes, 11-1, 11-20, 11-21, 11-22
 - Color Saturation, 11-17, 11-19
 - Color Scheme menu, 11-20
 - Color Schemes, 11-1
 - color to, 11-22
 - Colors, 11-4
 - Combining Channels, 2-1, 7-5, 7-6, 7-7, 8-4, 10-5
 - Conformity, 1-3, 3-1, A-12
 - Continuous Averaging, 10-3, 10-10
 - Controls
 - Menu buttons and knobs, 4-2
 - COPY FILES, 12-18
 - Copy from, 11-22
 - COPY SCHEME, 11-22
 - COPY TEMPLATE TO, 12-14
 - COPY TEMPLATE TO FLPY, 12-13
 - Copying Color Schemes, 11-22
 - Copying files between storage media, 12-10
 - Coupling, 5-3, 8-5, 8-36, 8-38, 8-43, 8-45, A-5
 - COUPLING button, 5-2
 - Cursors
 - Absolute, 14-1, 14-2, 14-5, A-10
 - Amplitude, 14-1
 - color, 11-21
 - Difference, 14-5
 - in FFT (Fast Fourier Transform), C-12
 - Persistence, 14-1
 - Reference, 14-5
 - Relative, 14-1, 14-2, 14-5, A-10
 - Time, 14-1
 - Cursors Measure, 12-19
 - CURSORS/MEASURE, 4-5, 14-5
 - Custom Menus 14-5
 - Custom Parameters, 14-6, 14-10, 14-11, 14-12, 14-13, 14-14
 - Cycles, D-5
 - in parameter measurements, D-2
 - Cyclic Mean, D-5
 - Cyclic Median, D-5
 - Cyclic Parameters, D-3
 - Cyclic Root Mean Square, D-5
 - Cyclic Standard Deviation, D-6
- D**
- Data, D-6
 - Data density, D-1
 - Data Edge, 14-14
 - Data Format, 13-3
 - Data Maps, 11-1, 11-15, 12-12
 - Data Points, 11-21
 - Day/Mnth/Year, 12-4
 - DC, 8-5, C-15

- DC Accuracy, A-3
 - DC Level, 12-23
 - DC Offset
 - compensating for, 10-15
 - Deadtime
 - reducing it using Sequence Mode, 7-3
 - Decimation
 - in FFT, 10-20
 - Delay, D-6
 - DELAY, 6-3
 - Delay By, 10-16
 - DELETE THIS DIRECTORY, 12-15
 - Deleting Files, 12-9
 - Deskew function, 10-16
 - Differential Time Measurements, D-3
 - Digital Filters, 10-11
 - Digitizers, A-1
 - Directory, 12-7, 12-11, 12-15, 12-16, 12-17
 - Disk Density, 12-13
 - Display, 2-3, 11-1, 11-2, 11-4, 11-5, 11-8, 11-9, 11-10, 11-11, 11-12, A-8
 - on-screen sections and fields, 4-9
 - Standard, 11-7
 - XY, 11-7
 - DISPLAY, 4-5, 11-13, 11-16, 11-18
 - Display Area Size, A-8
 - DISPLAY button, 11-7
 - Display Order, 11-3
 - Display Resolution, A-8
 - Display Scaling, 10-20
 - Display Setup, 11-13
 - general, 11-7
 - XY, 11-16
 - DISPLAY SETUP, 11-1, 11-14, 11-18
 - Displayed Trace Label, 4-9, 10-3, 10-20
 - Distortion
 - FFT, C-4
 - DO COPY, 12-18
 - DO RECALL, 13-4, 13-5, 14-21, 15-3
 - DO STORE, 13-2
 - DOS. *See* UTILITIES:Mass Storage
 - Dot Join, A-8
 - Dropout Trigger, 8-28, 8-42, A-6
 - Dual Grid, 11-9
 - Duration, D-7
 - Duty, D-7
 - Dynamic Range
 - improving it, C-6
- E**
- Earth, 3-2, 3-3
 - ECL/TTL, 5-3
 - Edge menu, 8-45
 - Edge Trigger, 8-1, 8-2, 8-5, 8-8, 8-34
 - Edge Trigger with Hold-off, 8-5
 - Edge Trigger with Hold-off by Events, 8-7
 - Edge-Qualified Trigger, 8-20, 8-26, 8-41
 - Edge-Qualified Trigger with Wait, 8-23
 - ENBW, C-17
 - Enhanced Resolution Filtering, 10-11, B-1, B-2, B-3, B-4, B-5, B-6, C-6
 - Enhanced Resolution Setup, 10-11
 - ENTER NEW FILE NAME, 12-16
 - Envelope, 10-12
 - ERES, A-9
 - Errors
 - detecting them in remote control. *See* Remote Control Assistant
 - Events, 8-7, 8-21, 8-23, 8-34
 - Trigger Hold-off by, 8-7
 - Excel, E-2
 - Exclusion Trigger, 8-12, 8-36
 - Expansion Factor, 12-3
 - EXT, 8-4, A-6



External Clock, 7-8, 7-9, A-5
External Reference, A-5
Extrema, 10-3, 10-12, 11-3, A-9

F

Fall, D-2
Fall 80–20 %, D-7
Fall at Level, D-7
Fall time, 14-9, D-2, D-7
Falling edge, 14-13
FFT (Fast Fourier Transform),
10-18, 10-19, A-9, C-1, C-8,
C-9, C-17
FFT Algorithms, C-14
FFT Average Setup, 10-14
FFT Error Messages, C-13
FFT Interruption, 10-13
FFT menus, 10-13, 10-14
FFT result menu, C-10, C-11
FFT Span, 10-18, 10-19, 10-20,
10-21, 10-22
FFT Windows, 10-13, C-5, C-6,
C-11, C-17, C-19, C-20
Fields, 8-39
File, 13-5, 14-21
File Deleting, 12-9
File Naming, 12-8, 12-9, 12-15,
12-16
File Transfers, 12-10
File Type, 12-16
Files, 12-7, 12-9, 12-10, 12-12,
12-14, 12-18, 15-3
Fill, 12-9
Filters, B-1, B-2, C-3, C-4, C-18
FIR (Finite Impulse-Response)
filter, B-1, B-2, C-6
Firmware Update, 12-19
First, D-8
FLASH UPDATE, 12-22
Floor, 10-12
in extrema waveforms, 10-3
Floppy Disk, 12-7, 12-9, 12-10,
12-11, 12-12, 12-13, 12-15,

13-1, 13-2, 13-5, 14-21, 15-1,
15-2, A-11
FLPY UTIL, 12-12
for Math use max points menu,
10-19, C-9
format, 12-2
Format, 12-3
FORMAT FLPY, 12-13
Format Hard Disk, 12-14
Frequency, 11-7, 12-1, 12-23,
B-2, C-1, C-3, C-4, C-5, C-9,
C-12, C-15, C-20, D-8
Frequency bins, C-18
Frequency Range, C-18
Frequency Resolution, 10-18,
C-2, C-8, C-11, C-19
Frequency Span, 10-19, 10-20,
C-8
from, 15-3
from Card, Flyp or HDD, 15-2
from Memory, 13-4
Front Panel, 12-19
Front Scope Cover, 1-3
Front-panel Controls, 4-2
Full Dialog. *See* Remote Control
Assistant
FULL FORMAT, 12-14
Full Screen, 2-3, 8-14, 11-1, 11-10
FULL SCREEN, 4-2, 11-10
Fuses, 1-3, 3-3

G

General Instrument Reset, 4-7
Glitch Trigger, 8-10, 8-35, 8-36
Global BWL, 12-19. *See*
Bandwidth Limiting. *See*
Bandwidth Limiting
GPIB, 4-6
GPIB Address, 12-6
GPIB and RS232, 12-1, 12-2,
12-3, 12-20, A-11
GPIB Port, 12-5, A-11
GPIB/RS232 Setup, 12-1, 12-6
Graticules, A-8

Grid Color, 11-21
Grid intensity, 11-13
Grids, 11-7, 11-8, 11-9, 11-11,
11-13, 11-14, 11-16, 11-18, A-8
Ground, 3-2, 3-3
Ground and Trace Level markers,
4-9

H

Hard Disk, 12-7, 12-10, 12-14,
12-15, 13-1, 13-2, 13-5, 14-21,
15-1, 15-2
Hardcopy, 2-3
Expansion factor, 12-3
Hardcopy Setup, 12-1, 12-2, 12-3
Harmonics, C-2, C-5
HDD (portable hard disk), 12-7,
12-14, 12-15, 13-2, 13-5,
14-21, 15-1, 15-2
HF
in Triggering, 8-5
High-Frequency Triggering, 8-5
Histograms, A-9, D-1
Holdoff, 8-43
Hold-off, 8-5, 8-19, 8-34, A-6
Hour/Min/Sec, 12-4
HPGL, 12-2
Humidity, 3-1
Hysteresis, 14-13, 14-14, D-4
hysteresis menu, 14-13, 14-14

I

In, 12-19
Input Coupling, A-3
Input Impedance, 5-3, A-3
INSERT, 12-16, 12-17
Interfacing, 2-3, A-11
Interleaving, 7-2
Internal Memory, 13-1, 13-4, 13-5,
15-1
Internal Printer Setup, 12-3
Interpolator Resolution, A-5
Interval Trigger, 8-12, 8-13, 8-14,
8-15, 8-16, 8-38

L

Landscape, 12-3
Last, D-8
Leading Edge, D-2
Leakage, C-5, C-11, C-19
Level, 14-13
LEVEL, 6-4, 8-1
level menu, 14-13
LINE, 8-4
LOAD CHANGES NOW, 12-4
Lobes, C-2, C-5, C-17, C-19
Log, 12-20
Low-Frequency Triggering, 8-5
Low-pass Filtering, B-2, B-4, C-6

M

Magnitude, C-4, C-6, C-10, C-15,
C-16
Maintenance, 1-2
MAKE THIS DIRECTORY, 12-17
Mask Testing, 14-15, 14-19,
14-20, 14-21
Mass Storage, 12-7, 12-15, 12-16,
12-18
MASS STORAGE, 12-10, 12-12,
12-14
Math Functions, 9-1, 10-2, 10-6,
10-15, 10-18, 10-19, 10-20
Speeding them up, 10-5
MATH SETUP, 9-2
Math Type, 10-16
Math Type menu, C-11
Mathcad, E-1, E-9, E-10, E-14,
E-15
MathCad, 13-3
MATLAB, 13-3, E-1, E-11, E-16
Maxima
in extrema waveforms, 10-3
Maximum, D-8
Maximum Input, A-4
Maximum Sampling Rate, 7-2, 7-5
Mean, D-8
MEASURE, 14-16
Measure Gate, 11-21



Measurement Gate Highlighting,
11-4, 11-21
Median, D-9
Medium-to-High-Frequency
Triggering, 8-5
Memories, 2-1, 13-1, 13-4, 13-5,
15-1, 15-2, A-10
Memory, A-2, A-3, A-9, C-4, C-12
Memory Card, 12-7, 12-10, 12-15,
13-1, 13-2, 13-5, 14-21, 15-1,
15-2
Memory Used/Available
Summary, 16-5
Menu buttons and knobs, 4-2, 4-3
Menu Options, 4-4
Menu-Entry buttons, 4-3, 4-5, 4-6,
5-3, 9-2, 11-7, 11-10, 12-1,
13-1, 13-4, 14-5
Menus
moving through them, 4-3,
4-5
Mesial, D-2
Message Field, 4-9
Microprocessor, A-9
Minima
in extrema waveforms, 10-3
Minimum, D-9
mode, 12-23
MORE DISPLAY, 11-20
More Display Setup, 11-13, 11-14,
11-16, 11-18
MORE VERSION
INFORMATION, 16-2
Multiple Grids, 11-12
Multi-Zoom, 10-8
MULTI-ZOOM & AUTO-SCROLL,
10-6

N

Neutral Color, 11-21
use in Measurement Gate
Highlighting, 11-4
NEW DIRECTORY, 12-17
New Directory on Card, 12-17

Noise Reduction, 10-3, B-2, B-6
NORM, 6-2, 7-11, 10-3
Number of points, 7-6, C-14, C-19
Nyquist Frequency, 10-19, 10-20,
B-2, C-4, C-5, C-9, C-12, C-19

O

Objects
displaying them, 11-1, 11-2
Octal Grid, 11-12
Offset behavior, 5-3, 7-11, 12-1,
12-19
OFFSET knob, 5-1
Offset Range, A-1
Offset scaling, 4-7
Opaque Mode, 11-3, 11-20
Operand, 10-9
Operating Environment, 3-1, A-11
Operator, 10-9
Options installed
information on, 16-2
OR interval, 8-38
Output Formats, A-11
output to, 12-3
Over +, D-9
Over-, D-9
Overflow, B-3
Overlap Management, 11-1, 11-3,
11-20
Overlays Color, 11-21
Overload, 3-3, 5-3, 5-6
Oversampling, B-1
Overvoltage, 3-1

P

Packing and Shipment, 1-3
page feed, 12-2
PANEL SETUPS, 4-6, 15-1, 15-2,
15-3
PANEL SETUPS button, 15-1
Parameter Analysis, A-9
Parameter Categories, 14-11,
14-12

- Parameter Display, 11-10
Parameter symbols, 14-6, 14-7
Parameters, 10-3, 14-6, 14-8, 14-9, 14-10, 14-11, 14-12, 14-13, 14-14, 14-15, 14-16, 14-17, 14-18, 14-19, 14-20, 14-22, A-10, D-1, D-5, D-6, D-7, D-8, D-9, D-10, D-11
Parity, 12-6
Pass/Fail Testing, 11-4, 12-23, 14-6, 14-15, 14-16, 14-17, 14-18, 14-19, 14-20, 14-21
Pattern, 8-22
Pattern Trigger, 8-17, 8-18, 8-19, 8-37, 8-43, A-6
PC, 12-7, A-11
PCMCIA. *See* UTILITIES:Memory Card
Peak Detect, 7-2, 7-6, A-4
Peak-to-Peak, 14-8, D-9
pen number, 12-2
Period, D-9
Periodic Signals, C-6
Persist, 11-15
Persist for, 11-15, 11-19
Persistence Decay, 11-5
Persistence, 11-13, 11-14, 11-16, 11-18, 11-19, 14-1, A-8
PERSISTENCE, 11-15
Persistence data maps, 11-5, 11-14
 memory allocation, 16-5
Persistence Setup, 11-14, 11-15
Phase, C-10, D-9
Phase Response, B-2
Picket Fence Effect, C-4, C-20
plot size, 12-2
Plotters, 12-2, A-11
Points, D-9
Pollution Degree, 3-1, A-12
Portrait, 12-3
POSITION, 9-2, 10-6
Post-Trigger, 6-3, A-5
Power, 3-3, A-11
Power Average, C-16
Power Averaging, 10-14
Power Density, 10-13, C-10, C-16
Power Density Spectrum, C-4, C-20
Power On
 Self-Test, 3-3
Power Requirements 3-2
Power Spectrum, 10-13, C-4, C-10, C-16, C-20
Power-off, 3-1
Power-on, 3-1
Precise Timing Measurements, 10-1
Pre-Trigger, 6-3, A-5
Primary menus, 4-3
printer, 12-2
Printers, 12-2, 12-3, 12-5, A-11
Probe Attenuation, 5-3
Probe Calibration, 5-5
Probes, 1-3, 5-5, A-7
ProBus, 1-3, 5-5
Processors, 2-1
Protective Conductor Terminal, 3-2
Pulse Width, 8-13, 8-35, 8-36, 8-37, 8-46
Pushbutton auto-repeat, 12-21
- Q**
- Quad Grid, 11-9, 11-10
Qualifications
 in Triggering, 8-2
Qualified First Trigger, 8-24, 8-25, 8-44
Qualified Triggers, 8-20, 8-21, 8-40, 8-41, 8-44, A-7
Qualifier. *See* Qualified Triggers
QUICK FORMAT, 12-14
- R**
- RAM, A-4, A-5, A-9
Read time cursor amplitudes, 12-19
Real Time Clock field, 4-9
Real, Real + Imaginary, Imaginary FFT, C-10



- Real-Time Display
 - See Roll Mode, 7-3
 - RECALL W'FORM, 4-5, 13-4, 13-5
 - Recall/Save, 15-1
 - Recalling Setups, 15-2, 15-3
 - Record, 7-8
 - Record Length
 - maximising it, C-8
 - Record up to, 7-7, 7-8
 - Reducing Noise, 10-3, B-2, B-6
 - Reference Memories, 10-5
 - Relative Mode. *See*
 - Cursors:Relative
 - Relative Time Cursors, 10-1
 - Remote Control, 2-3
 - Remote Control Assistant, 12-19, 12-20
 - Remote Enable, 4-4
 - Resample
 - deskew math function, 10-16
 - Rescale Setup, 10-17
 - RESET, 9-2, 10-1
 - Resolution, B-1, B-2, B-3
 - Resolution Bandwidth
 - in FFT, 10-18
 - RESTORE DEFAULT NAME, 12-16
 - Return, 1-3
 - RETURN, 4-3, 11-10
 - RIS (Random Interleaved Sampling), 2-2, 7-1, 7-2, 7-6, 7-7, 8-28, A-4
 - AUTO, 6-2
 - SNGL, 6-3
 - STOP, 6-1
 - Rise, D-2
 - Rise 20–80 %, D-10
 - Rise at Level, D-10
 - Rise time, 14-9, D-2, D-10
 - Rising edge, 14-13
 - Roll Mode, 7-1, 7-3
 - AUTO, 6-2
 - NORM, 6-2
 - SNGL, 6-3
 - STOP, 6-1
 - Roof, 10-12
 - in extrema waveforms, 10-3
 - Root Mean Square (rms), 14-8, D-2, D-11
 - RS232 Cabling, 12-3
 - RS-232-C, 4-6
 - RS-232-C Connector Pin Assignments, 12-5
 - RS-232-C Port, 12-5, A-11
 - Runt Trigger, 8-30, 8-31, 8-45, A-7
- ## S
- Safety, 3-1, A-12
 - Sample Clock, 7-6, 7-8, 7-10
 - Sample rate
 - increasing it by combining channels, 2-1, 7-5
 - Sample Rate, A-2, A-3, A-4
 - Sampling, 7-8, 7-9
 - FFT, C-1
 - Sampling Modes, 7-1
 - Sampling Period
 - in FFT, 10-19
 - Sampling Rate, 7-3, 7-6, B-1
 - Sampling thresholds, 7-8
 - Saturate at, 11-17, 11-19
 - Saturation, 11-6, 11-14, 11-15
 - Saving Setups, 15-1
 - Scale Factors, A-3
 - Scaling
 - in FFT, 10-20
 - Scallop Loss, C-4, C-17, C-20
 - Scope Explorer, 2-3
 - SCREEN DUMP, 4-6, 12-2
 - Screen Intensity
 - Grid, 11-13, 11-16, 11-18
 - Waveform and Text, 11-13, 11-16, 11-18
 - Screen Save, 11-20
 - Screen Type, A-8
 - Secondary menus, 4-3

- Segments, 6-1, 6-2, 7-3, 7-8, 7-9, 7-10, 10-3, E-8, E-10
 - SELECT ABCD, 9-1
 - SELECT CHANNEL, 5-1
 - Self-Test, 3-3
 - Sensitivity, A-1
 - Sequence, 7-10
 - Sequence Mode, 7-3, 7-7, 7-8, 7-9, 10-3, 10-6, 12-19, A-4
 - AUTO, 6-2
 - NORM, 6-2
 - STOP, 6-1
 - Serial number, 16-2
 - Service and Repair, 1-2
 - SET CLOCK, 12-4
 - SET TO, 12-23
 - Setup ASCII Format, 13-2
 - SETUP parameter menus, 14-13
 - Setup Recall, 2-3
 - Setups, 2-3
 - Shape, 12-23
 - SHOW STATUS, 16-1
 - SHOW STATUS button, 4-6
 - Signal Interval, A-6
 - Signal Width, A-6
 - Signal-to-noise(SNR) ratio
 - improving it using Enhanced Resolution Filtering, B-1, B-2
 - SINGLE, 7-11
 - Single-Shot Acquisition, 10-3, A-4
 - Single-Shot Acquisition, 7-1
 - Single-Shot Mode, 6-2, 7-6, 7-7
 - Size, A-11
 - Slew Rate Trigger, 8-32, 8-33, 8-46, A-7
 - slope, 8-34
 - Slope, 8-46, 14-13, A-5
 - SMART Trigger, 2-2, 8-1, 8-2, 8-10, 8-11, 8-12, 8-13, 8-14, 8-15, 8-16, 8-17, 8-18, 8-19, 8-20, 8-21, 8-23, 8-26, 8-28, 8-30, 8-31, 8-32, 8-33, 8-35, 8-36, 8-37, 8-38, 8-39, 8-40, 8-41, 8-42, 8-43, 8-44, 8-45, 8-46, A-6
 - SMARTMemory, A-4
 - SNGL, 6-2
 - Software version information, 16-2
 - Source Trace, 10-7
 - Sources, A-5
 - Special Modes, 7-11, 12-1, 12-19
 - Spectral Analysis, 10-18, B-2, C-1, C-2
 - Spectral Power Averaging, C-6, C-7
 - Spreadsheet, 13-3, E-1, E-2, E-3, E-4, E-7, E-8, E-12, E-13
 - Standard Deviation, 14-8, D-11
 - Standard Display, 11-7, 11-13, 11-14
 - Standard Parameters, D-1
 - Standard Time Parameters, 14-9
 - Standard Voltage Parameters, 14-8
 - Standby, 11-20
 - State-Qualified Trigger, 8-20, 8-40
 - State-Qualified Trigger with Wait, 8-21
 - Statistics, 14-6, 14-8, 14-9, 14-10
 - STOP, 6-1, 7-11, 10-3
 - Stop bits, 12-6
 - Storage
 - Copy Files, 12-18
 - Storage Availability, 12-9
 - store, 13-2
 - STORE, 13-1
 - STORE W'FORMS, 13-1, 13-2
 - Summary, 16-1
 - Summed Averaging, 10-3, 10-10
 - SYSTEM SETUP, 4-5
 - System Summary, 16-2
- ## T
- Temperature, 3-1, A-11
 - Template, 12-10, 12-13, 12-14
 - TEMPLATE AND FORMATTING, 12-12
 - Text & Times Summary, 16-3
 - Text Color, 11-2, 11-21
 - Threshold, 8-30, 8-32, 8-33, 8-45
 - TIFF, 12-2, 12-8



- Time, 8-21, 8-23
 - in display, 11-7
 - Trigger Hold-off by, 8-34
 - Time and Frequency field, 4-9
 - Time at Level, D-11
 - Time intervals, D-2
 - Time Parameter measurements, D-2
 - Time Resolution
 - improving it with Zoom, 10-1
 - TIME/DATE, 12-4
 - Time/Date Setup, 12-1
 - TIME/DIV, 6-3
 - Time/Div Range, A-5
 - Timebase, 14-19, 16-1
 - TIMEBASE, 6-1, 10-19, 10-21
 - TIMEBASE + TRIGGER, 4-2
 - Timebase Clock, 7-1
 - TIMEBASE EXTERNAL, 7-8, 7-9
 - Timebase scaling, 4-7
 - TIMEBASE SETUP, 6-4, 7-6
 - Timebase summary, 16-1
 - Timebase System, A-5
 - Timeout, 8-22, 8-28, 8-42
 - Timing Parameters, 14-13
 - to, 13-4, 13-5
 - to be set to, 12-16
 - to Card, Flyp or HDD, 15-1
 - tolerance, 14-20
 - Top, D-1, D-2, D-11
 - Trace and Ground Level markers, 4-9
 - Trace Color, 11-21
 - Trace Display, 11-15
 - TRACE ON/OFF, 9-1, 11-3, 11-21
 - Traces
 - selection of, 5-1
 - Tracking, 14-8, 14-9, 14-10
 - Trailing Edge, D-2
 - Transient signals, C-1, C-11
 - Transparent Mode, 11-1, 11-3, 11-20
 - TRIGGER, 6-1
 - Trigger Amplitude, 8-4
 - Trigger Comparator, A-6
 - Trigger Configuration field, 4-9
 - Trigger Controls, 8-1
 - Trigger Coupling, 8-4, 8-34, 8-36, 8-38, 8-45, 8-46
 - Trigger Delay, 4-9, 6-3, 7-1, 8-28, 8-41, 8-44, 14-9
 - Trigger Events, 8-8, 8-34, 8-40
 - Trigger Holdoff, 8-43
 - Trigger Hold-off, 8-5, 8-34
 - Trigger Level, 6-4, 8-1, 8-4, 8-8, 8-17, 8-43, 14-13
 - Trigger Level arrows, 4-9
 - Trigger Level scaling, 4-7
 - Trigger Modes, 6-1
 - trigger on, 8-39
 - Trigger Out, 12-23
 - Trigger Range, 8-4, A-6
 - Trigger Ready, 12-23
 - TRIGGER SETUP, 6-4, 8-1, 8-34, 8-35
 - Trigger Slope, 8-5, 8-42
 - Trigger Source, 6-4, 8-3, 8-4, 8-34, 8-38, 8-42, 8-45, 8-46
 - Trigger Status field, 4-9
 - Trigger summary, 16-1
 - Trigger System, 2-2, A-5
 - Trigger Threshold, 8-17, 8-18, 8-19, 8-40, 8-41, 8-44
 - Trigger Timing, A-6
 - Trigger window, 8-13, 8-38
 - Triggering, 7-5, 8-1, 8-2, 8-9, 8-34, 10-3
 - AUTO, 8-1
 - NORM, 8-1
 - STOP, 8-1
 - TV signal on, 8-39
 - TV Trigger, 8-26, 8-39, A-7
 - TV Type, 8-39
- U**
- use Math?, 10-16
 - Using, 11-15, 11-17, 11-19
 - UTILITIES, 4-5, 7-11, 12-1

File Transfers, 12-10
Floppy Disk, 12-7, 12-12,
12-13
GPIB port, 12-5
Hard Disk, 12-7, 12-14
Hardcopy Setup, 12-2, 12-3
Mass Storage, 12-1, 12-7,
12-10
Memory Card, 12-7
Printers, 12-2, 12-3
RS-232-C port, 12-5
Special Modes, 12-1, 12-19

V

V/div Offset, 5-3, 5-6
Validation
in triggering, 8-20
VAR button, 5-2
Vertical Offset, 5-1
Vertical Resolution, A-3
increasing it, B-5
Vertical Sensitivity, 5-1
VGA, A-11
VOLTS/DIV knob, 5-2
Volts/div scaling, 4-7

W

Wait, 8-44
Warnings, 3-2
Warnings Color, 11-21
Warranty, 1-1, A-12
Waveform and Text intensity,
11-13
Waveform Mathematics, 10-2,
10-5, 10-6
Waveform Processing, 10-5, A-9,
C-1, C-7, C-11, C-12, C-14,
C-17, C-18
Waveform Recall, 13-4, 13-5
WAVEFORM RECALL, 4-5
Waveform Status, 16-4
Waveform Store, 13-1, 13-3
Weight, A-12
Which files, 12-18

Width, 8-36, 8-37, 8-46, D-11
Window Pattern Trigger, 8-19
Window Trigger, 8-8
with, 8-45, 8-46
with window menu, C-5
work with, 12-15
Wrap, 7-7, 7-8, 7-10, 7-11, 12-9

X

XY Display, 11-7, 11-11
XY Dual Display, 11-11
XY Persist Setup, 11-18
XY Persistence, 11-18
XY SETUP, 11-17, 11-19

Z

ZERO, 6-3
Zoom, 9-1, 9-2, 10-1, A-8
ZOOM, 9-2, 10-6
Zoom menu, 10-7
Zoom of Math Functions, 10-1

#



LeCroy National Contact ☎ Numbers

Argentina: Search SA

54-11-4775-8544

Australia: Philips Test and Measurement

2 9888 8222

Austria: Dewetron GmbH

0316 3070

Benelux: LeCroy Ltd.

1 235 524 288

Brazil: ATP/Hi-Tek Electronica Ltda

11 725 5822

Canada: Allan Crawford Assoc. Ltd.

Mississauga: 905 890 2010

N. Vancouver: 604 878 1002

Chile: Sistemas de Instrumentacion Ltda

2 6951137

Denmark: Lutronic ApS

43 42 9764

Eastern Europe: Elsinco GmbH, Vienna

1 815 04 00

Finland: Orbis OY, 0478 830

France: LeCroy Sarl,

1 69 18 83 20

Germany: LeCroy Europe GmbH,

6221 82700

Greece: IFIPCO, 1 67 25 970

Hong Kong: Schmidt Electronics

852 250 70333

Israel: Ammo, 3 547 2747

Italy: LeCroy S.r.l., Venice

41 456 9700

Japan: LeCroy Japan Corp.

Osaka: 6 396 0961

Tokyo: 3 3376 9400

Tsukuba: 298 41 5810

Korea: LeCroy Korea Ltd.

2 3452 0400

Mexico: Electroingenieria de Precision SA

559 7677

New Zealand: Philips Test and Measurement

649 8494 160

Norway: Avantec AS

22 76 38 70

Pakistan: Electro Tech Corp. Ltd.

21 493 9593/5171

Portugal: M.T. Brandao Lda.

2 830 27 09

Singapore: Abex Eng. Ltd.

841 2818

South Africa: Westplex Ltd.

11 787 0473

Spain: MT Brandao SL

1 803 1767

Sweden: MSS AB

8 544 107 00

Switzerland: LeCroy SA

North: 62 885 8050

West: 22 719 2228

Taiwan: Lecoln Tech. Co.

2 232 6368

Thailand: Measuretronix Ltd.

2 375 2733

Turkey: NETES

212 237 32 26

Unite Arab Emirates: Arab Engineers for

Trading Co. Ltd 899 0220/0440

United Kingdom, Ireland: LeCroy Ltd.

1 235 524 288

United States: 1 800-5-LeCroy

(automatically connects you to your local sales office)

Vietnam: Schmidt Vietnam Co Ltd.

4 8346 186