

# CTR2 / CTR2-AD

## CALIBRATION TARGET AND VERIFICATION ADAPTER FOR ESD

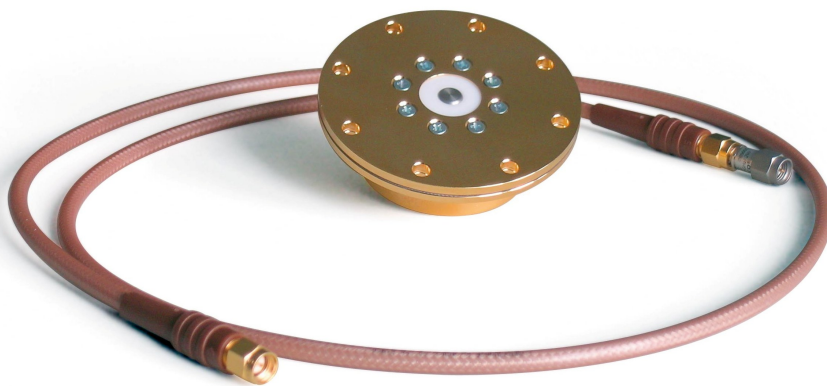

### FOR TESTS ACCORDING TO ...

- > EN 61000-4-2
- > IEC 61000-4-2
- > ISO 10605









### ESD CALIBRATION TARGET

The CTR 2 is a coaxial current target to monitor Electro Static Discharges built as required by EN/IEC 61000-4-2 Ed.2 standard. The target can be purchased as an option to the ESD generators, model dito or ESD 30. It can be used for measurements up to 30kV. Additional attenuators are available to match the output signal with the input capability of the oscilloscope.

### HIGHLIGHTS

- > **Current target as per IEC/EN 61000-4-2**
- > **20ohm impedance +/- 5%**
- > **Test voltage up to 30kV**
- > **Insertion loss +/- 0.5dB up to 1GHz**
- > **Insertion loss +/- 1.2dB up to 4GHz**
- > **Includes 20dB attenuator and 1m cable RG400**
- > **Additional attenuators available (optional)**
- > **50ohm Adapter line CTR 2-AD available (option)**

### APPLICATION AREAS

- |  |   |
|--|---|
|  INDUSTRY   |  RESIDENTIAL |
|  AUTOMOTIVE |  AVIONICS    |
|  COMPONENTS |  MILITARY    |
|  BROADCAST  |  MEDICAL     |
|  TELECOM    |   |

**TECHNICAL DETAILS**

**VERIFICATION/CALIBRATION**

**VERIFICATION SET-UP FOR THE CTR 2 TARGET**

The current target is verified to meet the required insertion loss of +/-0.5dB up to 1GHz and +/-1.2dB up to 4 GHz.

In addition to the current monitor, a Huber&Suhner 2W/20dB attenuator with a 1m Huber&Suhner coaxial cable with type "RG400" connectors are used.

The ESD target, Attenuator A and Cable C form the so-called "Target-Attenuator-Cable" chain being calibrated in this set-up. Attenuators B and C may not be required.

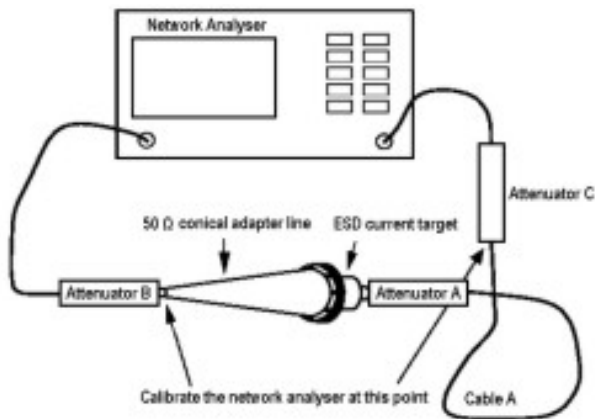

**INSERTION LOSS**

**S21 MEASUREMENT OF THE CTR 2 TARGET**

This figure gives the typical insertion loss characteristic of the "Target-Attenuator-Cable" chain.

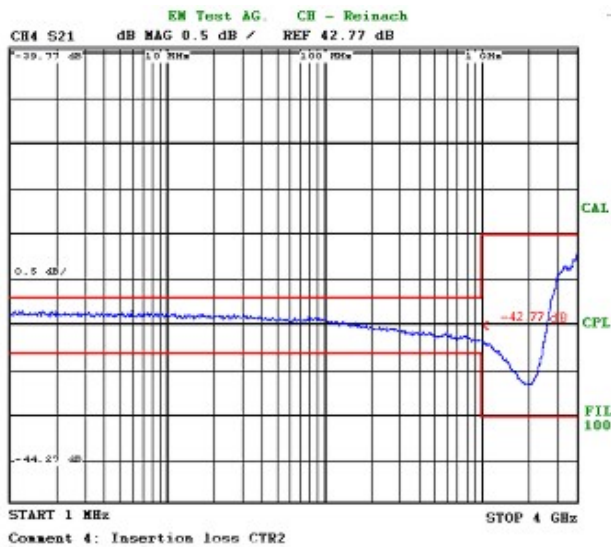

**CTR 2-AD 50 OHM CONICAL ADAPTER LINE**

**50 OHM ADAPTER LINE TO CALIBRATE THE CTR 2 TARGET**

The 50ohm conical adapter line connects the 50ohm cable to the input of the CTR 2 target. Geometrically it smoothly expands from the diameter of the 50ohm coaxial cable to the diameter of the target. If the target is made such that the impedance calculated from the diameter ratio  $d/D$  (refer to figure A2 of the IEC/EN 61000-4-2 standard document) not being equal to 50, the target adapter line shall be made such that the outer diameter of its inner conductor equals the diameter of the inner electrode of the current target.

The impedance is calculated considering the dielectric constant of the material that fills the conical adapter line (typically air). The target adapter line shall show an impedance of 50ohm +/-2% from DC to 4GHz. The reflection coefficient of two target adapter lines mounted face-to-face shall be better than 30dB up to 1GHz and better than 20dB up to 4GHz while the insertion loss shall be less than 0.3dB in the same configuration.



**TECHNICAL DETAILS**

**ESD WAVEFORM VERIFICATION**

**HOW TO VERIFY THE ESD PULSES?**

EM TEST recommends the following equipment in line with the IEC/EN 61000-4-2 standards requirements:

- DSO with a bandwidth of at least 2GHz
- Faraday cage
- EM TEST CTR 2 target

Capturing the correct waveform with the scope can only be achieved with the proper settings of the DSO. The settings need to be made to measure pulses with +/-2kV, +/-4kV, +/-6kV and +/-8kV. Four parameters need to be measured at each voltage level:

- Initial peak current
- Rise time between 10% and 90% of the initial peak
- Current value at 30ns
- Current value at 60ns

The time domain for the initial peak and rise time measurement is recommended to be set to 1ns/Div. For the current measurement at 30ns and 60ns a setting of 10ns/Div is recommended as being appropriate.

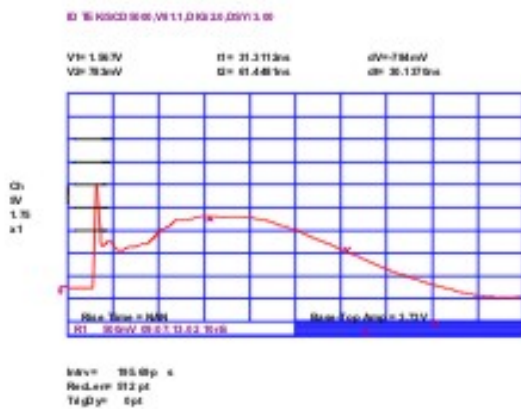

**MEASURING SET-UP**

**PULSE VERIFICATION SET-UP USING A SHIELDED ROOM**

This figure illustrates the proper set-up of the measuring equipment, the CTR 2 target and the ESD generator to be verified. Please observe that the ground return cable shall be pulled backwards at its mid point to form a large loop. This is of high importance as the ground return cable may heavily influence the ESD pulses, especially at the measuring point at 30ns and 60ns. If this fact is not properly observed you may see oscillations on the scope disturbing the pulse characteristic.

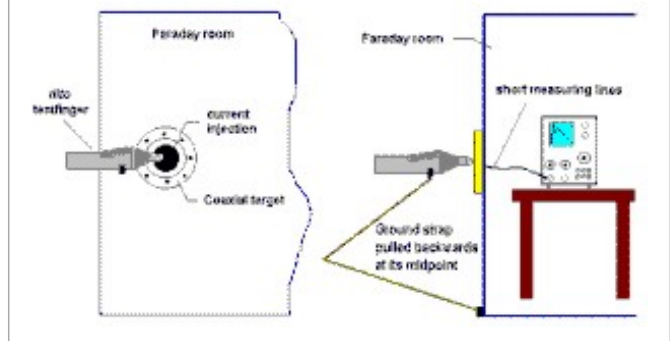

**HOW TO CALCULATE THE RATIO?**

**RELATIONSHIP BETWEEN PEAK CURRENT VALUE AND MEASURED PEAK VOLTAGE**

Calculated from the impedance and attenuation values the following equation gives the proper ratio:

$$I_p = 5 \times V_m$$

where

$V_m$  is the voltage signal measured by the DSO in Volt  
 $V_1$  is the voltage measured accross the CTR 2 target  
 $I_p$  is the discharge current

Therefore

$$V_1 = 20dB \times V_m = 2ohm \times I_p$$

$$I_p = 20dB \times V_m / 2ohm$$

For example:

A discharge current of 7.5A will give a voltage reading of 1.5V on the DSO.

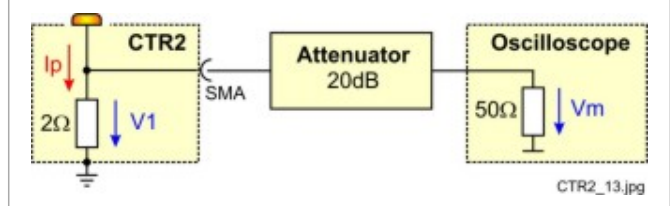

## TECHNICAL DETAILS

TECHNICAL DATA	
Measuring resistor	20ohm $\pm$ 5%
Design	As per IEC 61000-4-2, Ed.2:2008 and EN 61000-4-2:2009
Installation	The target shall be mounted into the wall of a shielded room or into a metal plate of at least 1.2m x 1.2m size.
Output	Coaxial SMA connector
Attenuator	An additional attenuator must be connected to the output of the CTR 2 depending on the input capability of the oscilloscope.
Insertion loss	$\pm$ 0.5dB up to 1 GHz and $\pm$ 1.2dB up to 4GHz This must always be measured as a "Target-Attenuator-Cable" chain. The target itself must not be measured.
ESD test voltage	$\pm$ 30kV
Dimension	70mm (diameter) x 30mm
Weight CTR 2	Approx. 400g

OPTION	
CTR 2-AD	50ohm adapter line for the verification of the CTR 2; 50ohm $\pm$ 2% up to 4GHz as per IEC/EN 61000-4-2

# COMPETENCE WHEREVER YOU ARE



## CONTACT EM TEST DIRECTLY

### Switzerland

EM TEST (Switzerland) GmbH > Sternhofstraße 15 > 4153 Reinach > Switzerland  
 Phone +41 (0)61/7179191 > Fax +41 (0)61/7179199  
 Internet: www.emtest.ch > E-mail: sales.emtest@ametek.com

### Germany

EM TEST GmbH > Lünener Straße 211 > 59174 Kamen > Deutschland  
 Phone +49 (0)2307/26070-0 > Fax +49 (0)2307/17050  
 Internet: www.emtest.com > E-mail: info.emtest@ametek.de

### France

EM TEST FRANCE > Le Trident - Parc des Collines > Immeuble B1 - Etage 3 > 36, rue Paul Cézanne > 68200 Mulhouse > France  
 Phone +33 (0)389 31 23 50 > Fax +33 (0)389 31 23 55  
 Internet: www.emtest.fr > E-mail: info@emtest.fr

### Poland

EM TEST Polska > ul. Ogrodowa 31/35, 00-893 Warszawa > Polska  
 Phone +48 (0)518 64 35 12  
 Internet: www.emtest.com/pl > E-mail: info\_polska.emtest@ametek.de

### USA / Canada

EM TEST USA > 9250 Brown Deer Road > San Diego > CA 92121  
 Phone +1 (858) 699 1685 > Fax +1 (858) 458 0267  
 Internet: www.emtest.com > E-mail: sales.emtest@ametek.com

### P.R. China

E & S Test Technology Limited > Rm 913, Leftbank > No. 68 Bei Si Huan Xi Lu > Haidian District > Beijing 100080 > P.R. China  
 Phone +86 (0)10 82 67 60 27 > Fax +86 (0)10 82 67 62 38  
 Internet: www.emtest.com > E-mail: info@emtest.com.cn

### Republic of Korea

EM TEST Korea Limited > #405 > WooYeon Plaza > #986-8 > YoungDeok-dong > Giheung-gu > Yongin-si > Gyeonggi-do > Korea  
 Phone +82 (31) 216 8616 > Fax +82 (31) 216 8616  
 Internet: www.emtest.co.kr > E-mail: sales@emtest.co.kr

Information about scope of delivery, visual design and technical data correspond with the state of development at time of release. Technical data subject to change without further notice.